

Instruction Manual

AE SERIES

(P/N Type)



Head Office 745 Aoji-cho Kusatsu 525-0041 Japan
Phone: +81-77-561-2111 Fax +81-77-561-2112

US Office
CA office: 2570 N,First St.,Suite 200 San Jose CA 95131
Tel:+1-408-273-4573 Fax:+1-408-273-4673

NY office: 80 Orville Drive Suite 100 Bohemia NY 11716
Tel:+1-631-244-1407 Fax:+1-631-244-1496

TX office: 5430 LBJ Freeway, Suite 1200 Dallas, TX 75240
Tel:+1-972-663-9336 Fax:+1-972-663-9337

SAFETY

**This power supply unit generates high voltage and energy.
Electric shock may lead to death or serious injury.
Be sure to follow the instructions below and handle the unit with caution.**

1. BE SURE TO GROUND!!

Be sure to ground the power supply unit before use.

2. DO NOT TOUCH ANY HIGH VOLTAGE TERMINALS!!

Do not operate the power supply unless who is familiar with the operation precede, the hazards of high voltage, and the treatment for the electrical shock is present.

3. UNDERSTAND THE HAZARDS OF HIGH VOLTAGE!!

In case you let somebody operate the power supply for you, must be sure that he/she fully understands the hazards of high voltage and the areas where never can be touched.

4. CUT OFF THE POWER BEFORE TOUCH THE UNIT!!

Cut off the power, and check that the power is OFF, before you touch the power supply. Capacitors in the output circuit are still charged and dangerous even after the power has been cut off. Discharge all remaining high voltage by grounding them.

5. DISCONNECT THE INPUT LINES(AC LINES) !!

In case you need to touch the inside of the power supply following instruction manual, cut off the power and disconnect the input lines(AC lines), and ground all the capacitors and high voltage section.

Don't remove the case or touch the inside of power supply unless so instructed in the instruction manual.

6. OPERATE THE POWER SUPPLY WITH YOUR RIGHT HAND!!

In order to avoid the electric shock to your important organs. Operate the power supply with your right hand and keep your left hand off from the power supply.

For Safe Use

Symbols

Various symbols are used in this instruction manual and on the product for ensuring safety. What will be caused by ignoring the instructions given with the symbols or by improper handling are classified as shown below. Read carefully and understand the descriptions before proceeding to the main body of this manual.

 **Warning:** failure to follow the instructions with this indication may lead to death or serious injury.

 **Caution:** failure to follow the instructions with this indication may lead to injury or damage in property.

Meanings of the Symbols

Some of the symbols used are shown on the right.

 Indicates that which requires caution.

 Indicates that which forbidden.

 Indicates that which must be done.

 Indicates electric shock hazard.

Warning



NO

- Do not touch the output terminal or the leads or load connected to it while the unit is in operation or immediately after it is stopped. Otherwise it may cause electric shock or injury.



NO

- Do not install the unit in a place subject to steam or water vapor. Otherwise it may cause poor insulation and lead to fire or electric shock.



NO

- Do not install the unit in a place subject to dew condensation. Otherwise it may cause electric shock.



NO

- Do not modify or damage the cables. Otherwise it may cause electric shock.



NO

- Do not place any object on the unit. Dangerous situations may occur if the object drops or falls.
- Do not put any object in the unit. It may cause damage.



GROUND

- Be sure to ground the unit to avoid a rare possibility of electric shock. Otherwise it may lead to fire, electric shock or injury.



NO
DISASSEMBLY

- Do not disassemble, remodel or repair the unit. High voltage may be built up inside, which may cause electric shock.
- Disassembly, remodeling or repair hamper ensuring of safety and may lead to dangerous situations.



NO

- Do not install the unit outdoors or in a place subject to leaking of water, flood or snow. Otherwise it may cause electric shock.

For Safe Use

Caution



NO

- Do not install the unit upside down or on a wrong side. Insufficient heat release may cause deterioration of parts, which may generate smoke or set fire.



NO

- Do not use the unit in a place subject to high temperature or in an enclosed, limited area. It not only hampers the unit from achieving its performance but also causes deterioration of parts leading to smoking or burning.



NO

- Do not cover the vent holes of the unit. Vent holes are provided to prevent elevation of temperature inside. Covering them not only hampers the unit from achieving its performance but also causes deterioration of parts, which may generate smoke or set fire.



NO

- Do not install the unit and the remote controller in a place subject to direct cold air. Condensation may lead to electrical leak/burning.



NO

- Do not wipe the unit with chemicals (such as thinner) or wet cloth. It may allow water inside leading to electric shock, electrical leak or burning.



NO

- Do not install the unit in a place subject to corrosive gas or liquid (such as a place where chemicals are handled). Deterioration of parts may cause generation of smoke or burning.

- After reading this manual, be sure to store it in a place convenient for the users so that it can be referred to at anytime.

First-aid procedures to be implemented in case of electrical shock

(1) RESCUE

FREE VICTIM FROM CONTACT WITH LIVE CONDUCTOR QUICKLY.
AVOID CONTACT WITH EITHER LIVE CONDUCTOR OR VICTIM'S BODY.

Shut off high voltage at once and ground circuit. If high voltage cannot be turned off quickly, ground circuit.

An ax with a dry wooden handle may be used to cut high voltage line.

Use extreme caution to avoid resulting electric flash.

If circuit cannot be broken or grounded, use a dry board, dry clothing, or other nonconductor to free victim.

(2) SYMPTOMS

NEVER ACCEPT ORDINARY AND GENERAL TESTS FOR DEATH.

Symptoms of electric shock may include unconsciousness, failure to breathe, absence of pulse, pallor, and stiffness, as well as severe burns.

WHENEVER VICTIM IS NOT BREATHING PROPERLY, GIVE ARTIFICIAL RESPIRATION.

(3) TREATMENT

START ARTIFICIAL RESPIRATION IMMEDIATELY.

Perform artificial respiration at scene of accident, unless victim's or operator's life is endangered. IN THIS CASE ONLY, remove victim to safe location nearby, if new location is more than few feet away, give artificial respiration while victim is being moved.

After starting artificial respiration, continue without loss of rhythm for at least FOUR HOURS, or until victim is breathing without help.

If you have to change operators while giving artificial respiration, do so without losing rhythm of respiration.

(4) AFTER VICTIM REVIVES

Be prepared to resume artificial respiration, as he may stop breathing again.

When victim is COMPLETELY CONSCIOUS, give him a stimulant (NOT AN ALCOHOLIC DRINK) such as teaspoonful of aromatic spirits of ammonia in a small glass of water, hot coffee, or hot tea.

Keep victim warm and lying down until he has been conscious for at least fifteen minutes.

Artificial respiration

1.POSITION VICTIM

Place victim in face-upward position and kneel close to his ear.

2.CLEAR THROAT

Turn head to one side quickly wipe out any fluid, mucus, or foreign body from mouth and throat with fingers.

3.OPEN AIR PASSAGE

Tilt head back and extend neck to open air passage.

4.LIFT JAW FORWARD

Place thumb in victim's mouth and grasp jaw firmly. Lift jaw forward to pull tongue out of air passage. Do not attempt to hold or depress tongue.

5.PINCH NOSTRILS CLOSED

With other hand pinch nostrils closed to prevent air leak.

6.FORM TIGHT SEAL WITH LIPS

Rescuer's wide-open mouth completely surrounds and seals open mouth of victim,
This is not a kissing or puckered position—mouth of rescuer must be wide-open,

7.BLOW

Exhale firmly into victim's mouth until chest is seen to lift.
This can be seen by rescuer without difficulty.

8.REMOVE MOUTH AND INHALE

During this time, rescuer can hear and feel escape for air from lungs.
Readjust position if air does not flow freely in and out of victim's lungs.
Continue at a rate of 12 to 20 times per minute.
Breathing should be normal in rate with only moderate increase in volume so that rescue breathing can be continued for long periods without fatigue. Do not breathe too forcibly or too large a volume if victim is an infant or small child.

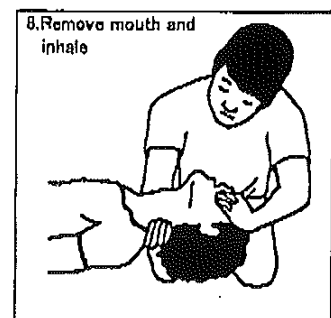
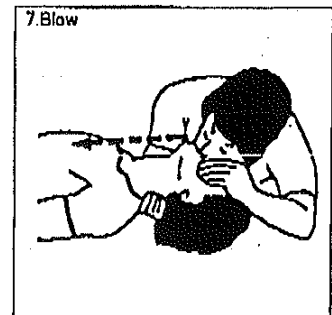
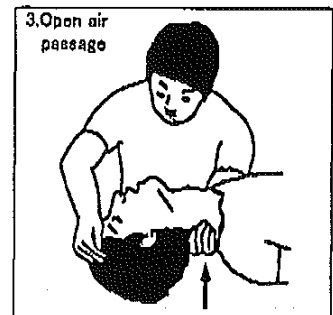
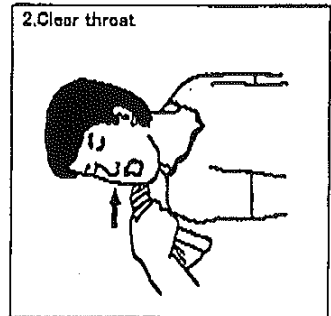

CONTENTS

	Page
Safety	i
For Safe Use	ii, iii
Rescue (First aid)	iv
Artificial respiration	v
 CONTENTS	 vi
 1. PREFACE	 1
1-1 Greetings	1
1-2 Unpacking	1
1-3 Installing Condition	1
1-4 Caution for Handling	2
 2. Exterior view diagram	 3
 3. Operation Manual	 4
3-1 Outline	4
3-2 Operating Method	4
3-3 Other Function	4
a. Protection against power failure	4
b. Protection against over voltage (O.V.P)	4
c. Over Current Protection (O.C.P)	5
d. Output current monitor (L1)	5
e. Output voltage monitor (L2)	5
f. External voltage control (L.V)	5
g. Remote Switch ON/OFF (LS)	6
h. Door Switch (LD)	7
i. Volume Control (LR)	7
j. Remote Reset (LT)	8
 4. SPECIFICATION OF OPTIONS	 9
4-1 List of optional features	9
4-2 How to order option	9
 5. EXPLANATION ON OPTIONAL FUNCTIONS	 10
5-1 Slow start (LW)	10
5-2 Current limit protection (LG)	10
5-3 No protection against power failure	10
5-4 GP-IB / RS-232C Control (LG)	10
5-5 AC230V Input (L(230V))	10
 6. Before making at a conclusion of trouble	 11

1.PREFACE

1-1.GREETINGS

Thank you very much for your purchase of our product, HIGH VOLTAGE POWER SUPPLY. We do our best to exercise quality control of our products. You will please handle this unit properly according to this operation manual so that you may display the full capacity of this unit, operate it for smoothly in high efficiency for many years to come and safely. We have done our best to prepare this operation but if you should recognize a doubtful or unknown point or an omission, we are very sorry but would you please contact our company immediately.

1-2. UNPACKING

When unpacking, you will please check the following question beside the power supply body.

ACCESSORIES

- AC input cord
- Instruction manual
- Output cable

1-3. INSRALLING CONDITON

- Install a high voltage power supply horizontally and use it.
- Do not place an object on the high voltage power supply absolutely.
- There are air suction holes for cooling and exhaust holes at upper and sides of the High voltage power supply. Providing an ample space to the high voltage power supply, use it at the place where the ventilating condition is as good as possible.
- Avoid using the unit at such places where it is very dusty or there is much corrosive gas etc.

1.PREFACE

1-4 CAUTION FOR HANDLING

WHEN TOUCHING LOAD AFTER TURNING OFF A HIGH VOLTAGE

1. Make the setting of an output voltage to zero (0). Turn off the HV ON/OFF switch.
2. Check and confirm that the voltage is zero at an output voltmeter of this unit. (The voltmeter on the power supply front panel does NOT read the output voltage when the power is turned off, even if a charge still exists on the load.)
3. Turn off the POWER ON/OFF switch.
4. Earthing an output for longer than 10 seconds, check and confirm that voltage is zero at another voltmeter (for high voltage). It is especially dangerous that the load is capacitive or a long cable is attached there to.
5. Make it a rule to touch load with right hand.

How to ground

- For safe operation, be sure to ground the ground terminal of power supply at One point on the ground.

If the Load frame is not grounded.

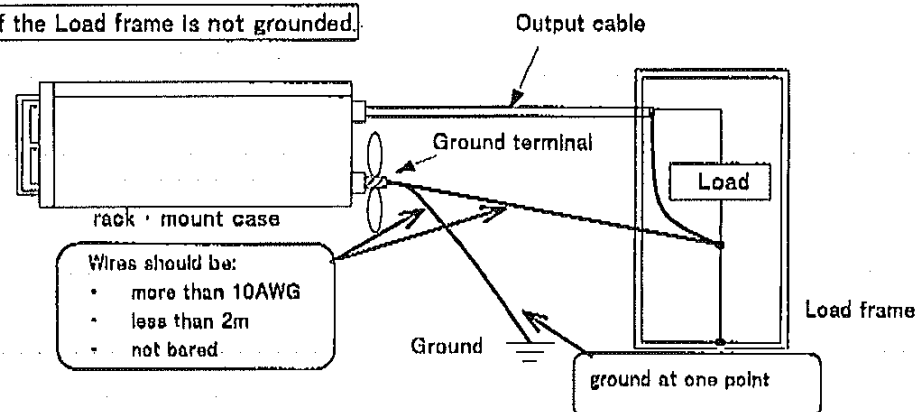

If the Load frame is grounded.

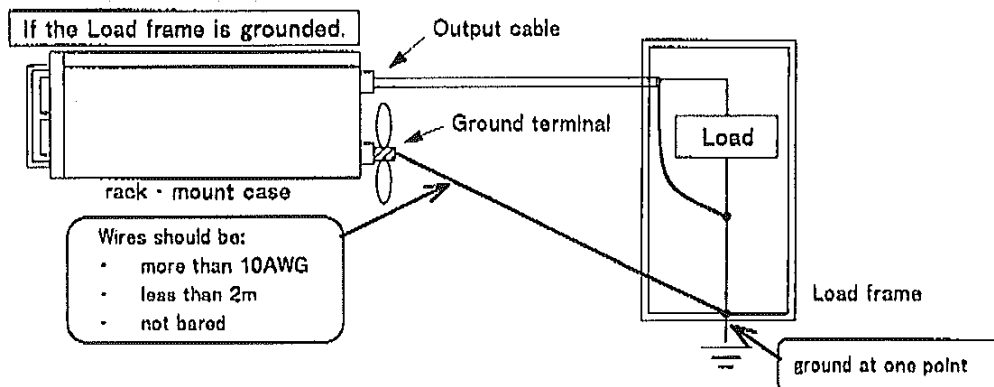

If there is a possibility of development of a short-circuiting of load or discharging, make larger and shorter the grounding conductor.

2.Exterior view diagram

2.Exterior view diagram

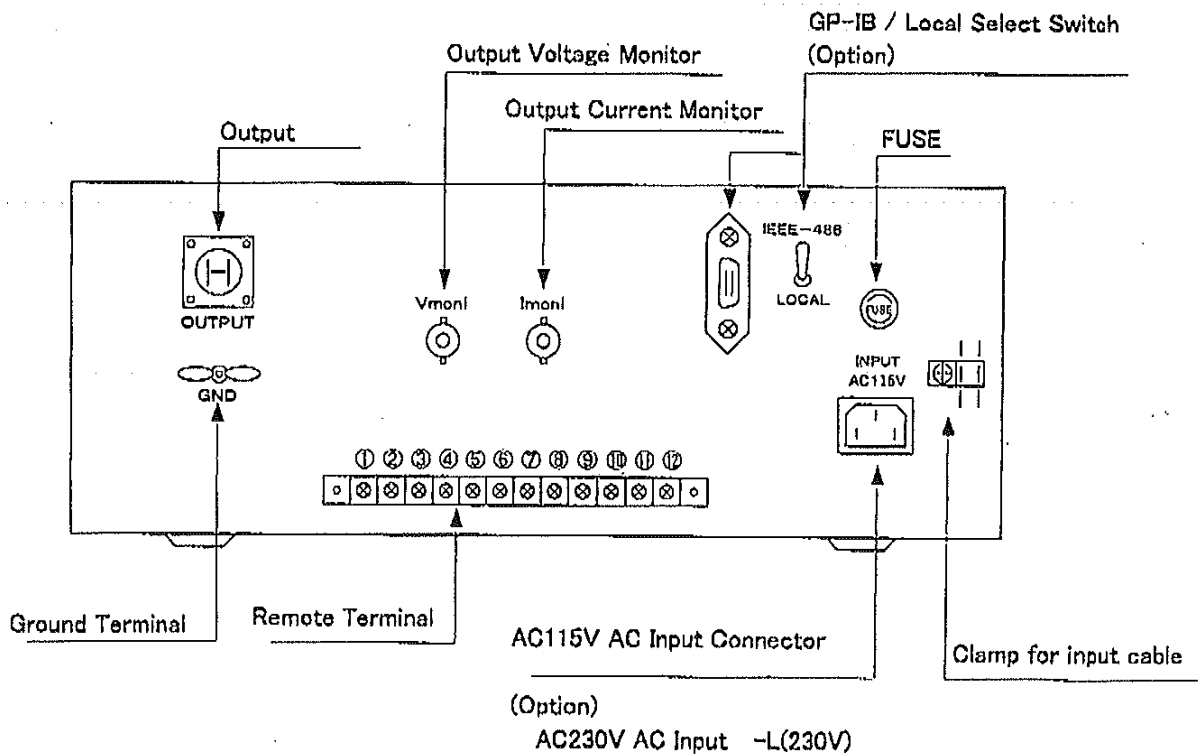
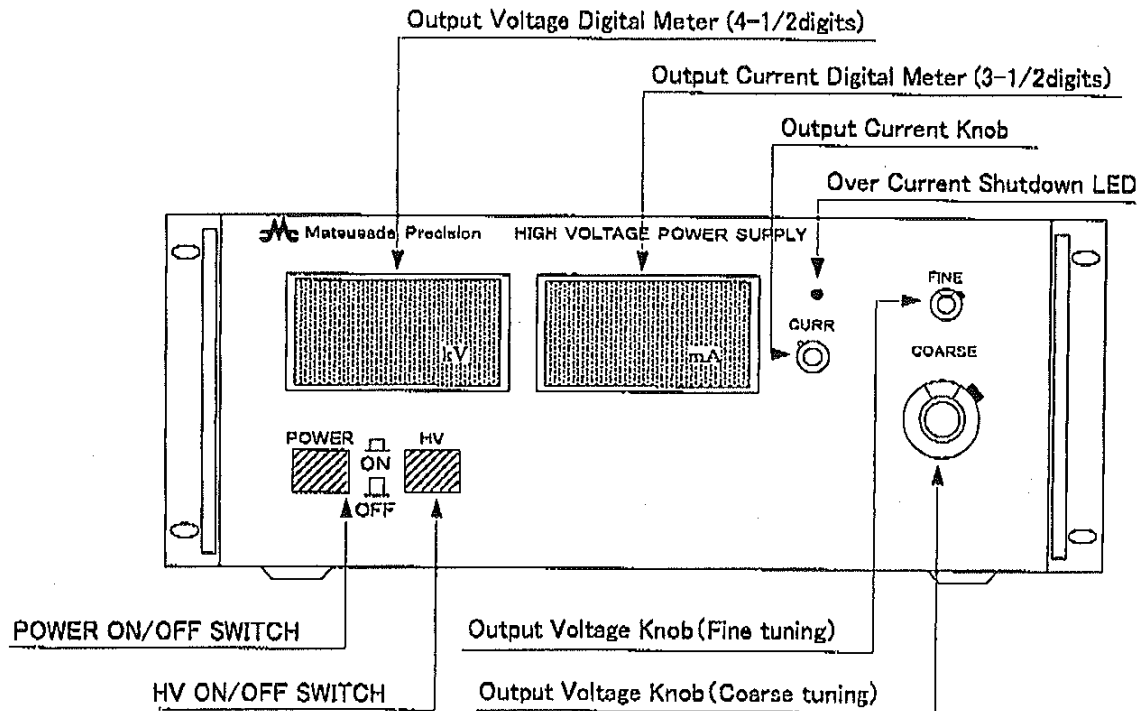

3.Operation manual

3.Operation Manual

3-1 Outline

This unit is a high performance rack mounting type high voltage power Voltage of AE series. It has been designed and manufactured, taking into full consideration easiness to use, high reliability and safety. Seeking for high function, it is very superior in cost performance.

3-2 Operation method

1. Upon confirming the connection made with this unit as specified (Refer to P.2[HOW TO GROUND]), operate it. Be sure to connect the earth with the ground terminal of the body.
2. Connect the attached AC input cord with AC 115V input connector (INPUT AC115V) at the rear panel and plug socket.
3. When the power ON/OFF switch is turned on, the power ON/OFF switch pilot lamp (hereinafter referred to as P.L.)(orange) will be lighted, resulting in being turned to a stand-by condition.
4. When the HV ON/OFF switch is turned on, the HV ON/OFF switch P.L. (red) will be lighted, resulting in being ready for operation. In this case, a voltage set with the output voltage setting dial (external control voltage at the time of controlling over external voltage) is inducted.

Therefore, pay attention to the display of output voltage.

5. Turning the output voltage setting dial (COARSE [COARSE ADJUSTMENT], FINE [FINE ADJUSTMENT, 10% of coarse adjustment], set it an optional voltage.

IF you want to lock at a set voltage, move the locking lever if the dial in a direction of arrow mark as illustrated hereunder,

it can be locked. Output voltage and current are displayed at the digital-meter at front panel.



OUTPUT VOLTAGE

6. For ending the operation of the power supply, be sure to return the output voltage setting dial (COARSE, FINE) to zero (if the same voltage is used again, leave it as it is), turn off the switches in the order HV ON/OFF switches, POWER ON/OFF switch.

3-3 Other function

a. Protection against power failure.

This unit has incorporated a circuit for prevention of action once again when power failure is corrected. If power failure is corrected while HV is under action, only POWER ON/OFF SWITCH P.L.(orange color) will be lighted, not outputting a high voltage output. For resetting, turn off the HV ON/OFF switch once and turn it ON once again.

b. Protection against over voltage (O.V.P) NOTE 1

This unit has incorporated a protection against over voltage. Even at the time of abnormality, it is limited at approx. 105% of the maximum rated voltage, protecting power supply and load against damage.

NOTE1)O.V.P.— Over Voltage Protection.

c. Over current protection (O.C.P)

This unit has an over current protection. If exceeding the output current set with CURR setting volume, the output will be cut off. While O.C.P is under action, the over current indicator LED (red) will be lighted, resulting in putting out of HV ON/OFF switch P.L (red). Setting can be varied continuously in a range of approx. 10% of rated output current - approx. 105%. If turned fully clockwise, it can be set at approx. 105%. For resetting, turn off the HV ON/OFF switch once and then, turn it on once again. (If provided with LC option, refer to (ITEM 5-2 Current Limit(LC) P.10)

d. Output current monitor (L1)

At the time of maximum output current, a voltage of 10V is outputted from the BNC connector of the rear panel. The output impedance is 1kΩ.

e. Output voltage monitor (L2)

At the time of maximum output voltage, a voltage of 10V

positive output ——— +10V

negative output ——— -10V

is outputted from the BNC connector of the rear panel. The output impedance is 1kΩ.

f. External voltage control (LV)

Output voltage can be controlled by the external voltage of 0 - 10V.

(CONNECTION DIAGRAM)

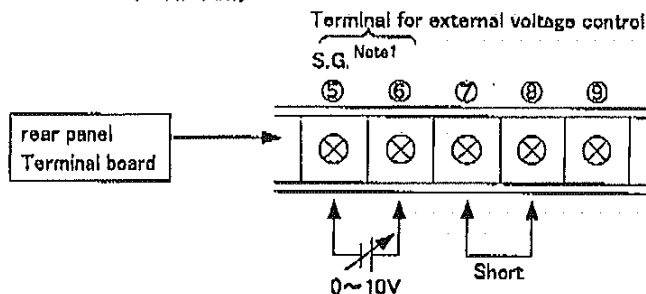

For external voltage operation, disconnect the short hardware between ⑧ - ⑨ and short ⑦ - ⑧. Then, input an external voltage (0 - 10V) between ⑤ - ⑥. The variation of external voltage exerts influence over the output as it is. Therefore, prepare such one as high in stability. The input impedance is 10kΩ.

When an external voltage control is used.

When no external voltage control is used.

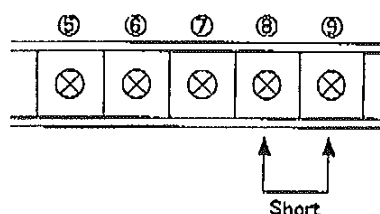

Disconnecting the short hardware between ⑦ - ⑧, if shorted between ⑧ - ⑨, LV function will not function. Control the output voltage with the output voltage setting dial of the front panel.

Note1) S.G.— Signal Ground.

3.Operation Manual

g. Remote switch ON/OFF(LS)

The output can be turned on and off with remote switch.

<CONNECTION DIAGRAM>

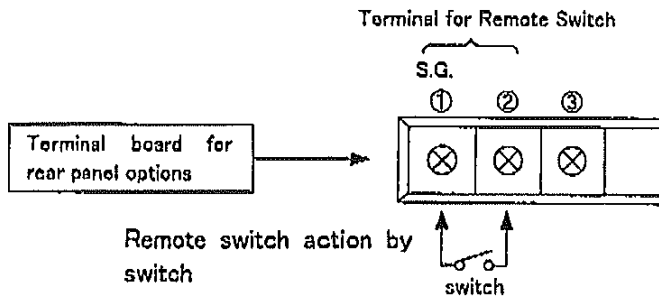

NOTE: if the output over-current protection is effective, no output will be turned on. Turning off the HV ON/OFF switch, reset it.

Remote Switch Action

SHORT Output ON
OPEN Output OFF

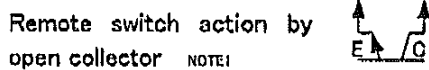

In place of switch, an open collector will suffice for it.

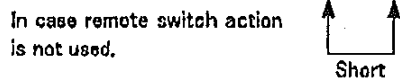

IF ① and ② are connected with an attached short hardware, LS function will not work

NOTE1 Caution for use of open collector

When an open collector is used with LS, LD and LT function, use them according to the following regulations.

DEFINITION OF OPEN COLLECTOR

OUTPUT	SWITCH	OPEN COLLECTOR
ON	<p>Short</p>	<p>Vce 0.4V or less (10mA)</p>
OFF	<p>Open</p>	<p>5V Vce 2V or more (open 5V)</p>

h. Door Switch(LD)

The output can be turned off with door switch.

For safety, if the door switch turned of, no output will be turned on.

Turning off the HV switch, reset it.

<CONNECTION DIAGRAM>

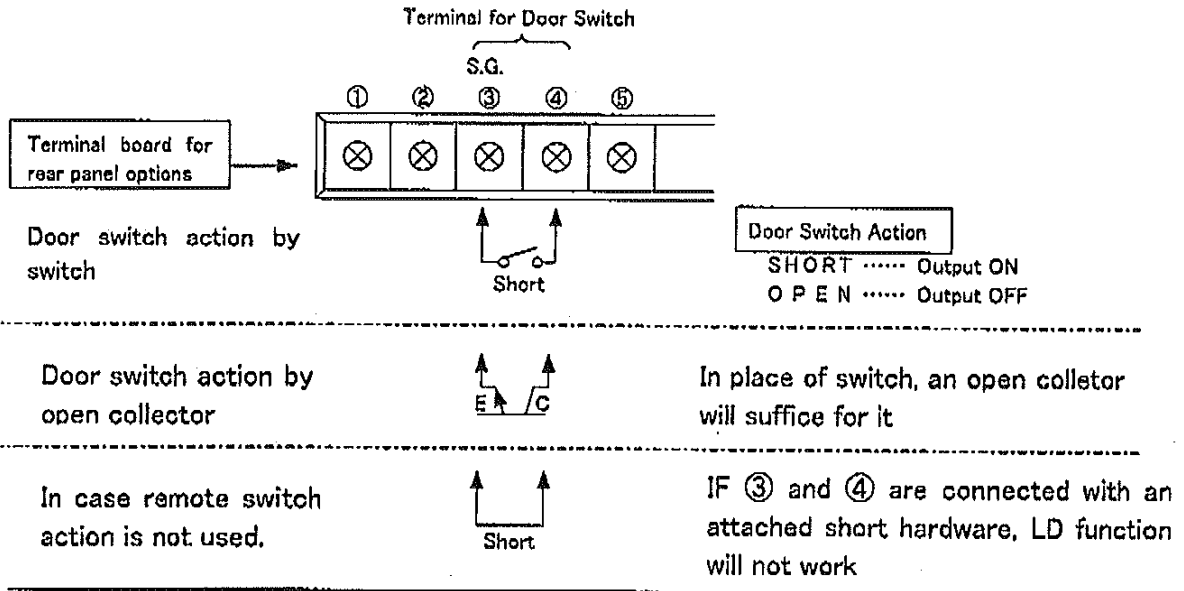

i. Volume control(LR)

The output can be controlled with external volume 5(kΩ)

<CONNECTION DIAGRAM>

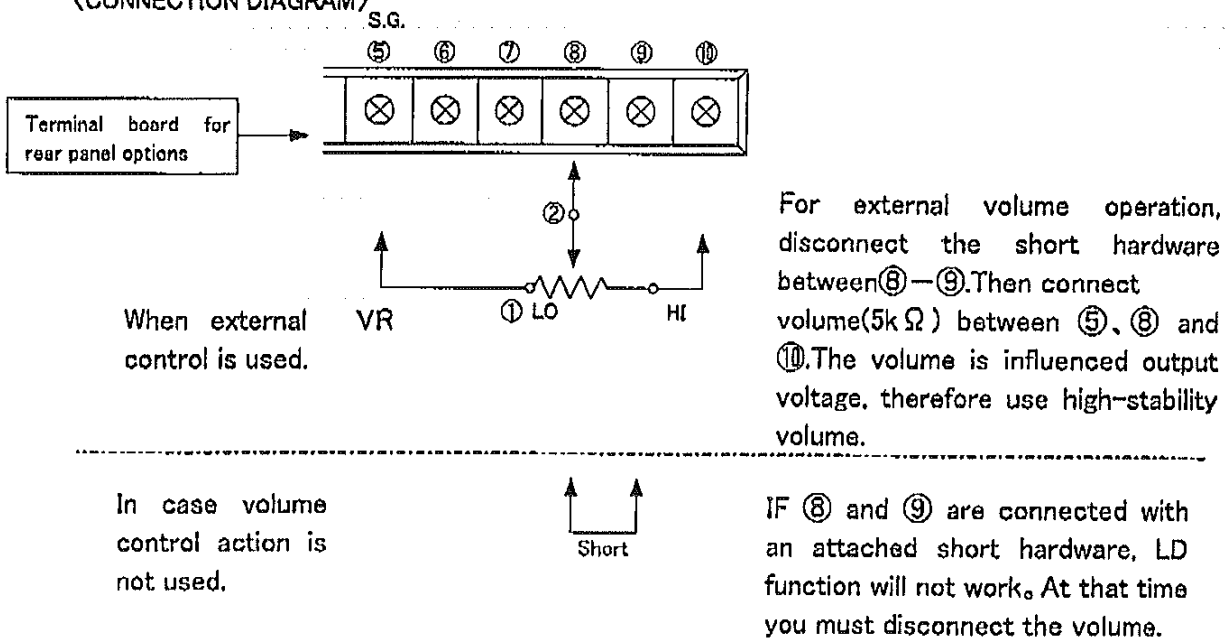

3.Operation Manual

j. Remote Reset(LT)

The O.C.P. can reset action by external switch.

<CONNECTION DIAGRAM>

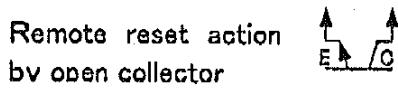
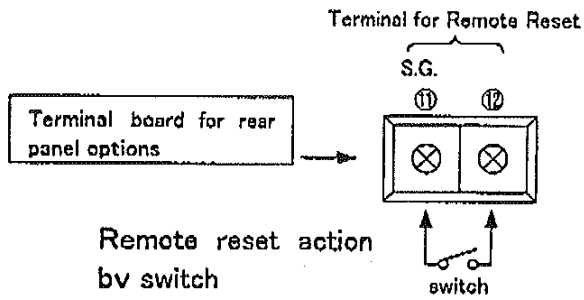

In place of switch, an open collector will suffice for it

FOR PREVENTION OF DANGER, BE SURE TO CONNECT GND TERMINAL WITH THE EARTH.

4.SPECIFICATION OF OPTIONS

4.SPECIFICATION OF OPTIONS**4-1 List of optional features(AE Series)**

This product is equipped with all features which have been checked in the table below, and you should therefore be sure to read the sections of the user's manual dealing with these

symbol	name	contents
<input type="checkbox"/> LW	Slow-start	The output slowly reaches to the adjusted voltage around 10 seconds after the power switch is on.
<input type="checkbox"/> LC	Current limit protection	Limit the output current at overload condition.
<input type="checkbox"/> LN	No protection against power failure	HV output linked input AC(ON/OFF)
<input type="checkbox"/> LG	Support GP-IB/RS-232C	Support GP-IB/RS-232C connector.
<input type="checkbox"/> L(230V)	AC230V input	Input voltage is AC230V±10%.

4-2 HOW TO ORDER OPTIONS

When you order, write a symbol after a series name as mentioned above.

<for example>

AE-1P30-LC (LC option)

AE-1N30-LC(230V) (LC,L(230V) option)

5.EXPLANATION ON OPTIONAL FUNCTIONS

5.EXPLANATION ON OPTIONAL FUNCTIONS

5-1 Slow Start (LW)

The output reaches to the adjusted voltage around 10 seconds after the HV switch is turned on.

5-2 Current Limit (LC)

The output current will be controlled at CURR volume.

When the output current is controlled, the indicator LED(red) will light.

5-3 No protection against power failure (LN)

Protection against power failure is standard.

Input power (ON/OFF) is linked output voltage(ON/OFF).

5-4 GP-IB/RS-232C Control (LG)

This function is available for external control and monitor.

By using GP-IB / RS-232C adapter, it is possible for the computer to operate power supply variously.

When GP-IB / RS-232C use, set switch and terminal the following

1. Short terminal between ⑦—⑧
2. Turn on GP-IB switch.

Give the full detail of GP-IB/RS-232C, refer to a GP-IB/RS-232C manual.

5-5 AC230V Input (L(230V))

In a standard, input voltage is AC115V±10%.

This option is provided input AC230V±10%

6. Before making at a conclusion of trouble

6-1. Before making at a conclusion of trouble

- In case no output voltage is induced:
 1. Check whether or not a specified voltage has been inputted.
 - 115V (or 230V option) AC $\pm 10\%$ 50/60Hz single phase of power voltage
 - Control voltage 0-10V at the time of controlling over external voltage
 2. Check whether or not optional functions have been connected as specified. (Refer to the Item 5 EXPLANATION ON THE OPTIONAL FUNCTIONS (P.10-) for the details.)
 3. Check whether or not over current protection of Item 3-3-c(P.5) is effective.

- In case a discharging noise is generated near a high voltage output block
 1. Check whether or not the plug block of the high voltage connector (part shown with an arrow mark hereunder) is stained. If used with plug stained, a discharging phenomenon will develop sometimes inside connector sometimes. Wiping off stains with such liquids as alcohol, dry it fully and use it.

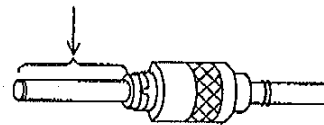

8. Before making at a conclusion of trouble

8-1. Before making at a conclusion of trouble

- In case no output voltage is induced:
 1. Check whether or not a specified voltage has been inputted.
 - 115V (or 230V option) AC $\pm 10\%$ 50/60Hz single phase of power voltage
 - Control voltage 0-10V at the time of controlling over external voltage
 2. Check whether or not optional functions have been connected as specified. (Refer to the Item 5 EXPLANATION ON THE OPTIONAL FUNCTIONS (P.10-) for the details.)
 3. Check whether or not over current protection of Item 3-3-c(P.5) is effective.

- In case a discharging noise is generated near a high voltage output block
 1. Check whether or not the plug block of the high voltage connector (part shown with an arrow mark hereunder) is stained. If used with plug stained, a discharging phenomenon will develop sometimes inside connector sometimes. Wiping off stains with such liquids as alcohol, dry it fully and use it.

