

**PAVI 09**

*June 22-26, 2009*

*College of the Atlantic  
Bar Harbor, Maine, USA*

# **Jefferson Lab Injector Development for Next Generation Parity Experiments**

P. Adderley, J. Clark, J. Grames, J. Hansknecht, M. Poelker,  
M. Stutzman, R. Suleiman, K. Surles-Law



# Upcoming Parity Experiments

Experiment	Hall	Start	Energy (GeV)	Current ( $\mu\text{A}$ )	Target	$A_{PV}$	Charge Asym	Position Diff (nm)
HAPPEX-III	A	Aug 09	3.484	85	$^1\text{H}$ (25 cm)	$16.9 \pm 0.4$ (ppm)	✓	✓
PVDIS	A	Oct 09	6.068	85	$^2\text{H}$ (25 cm)	$63 \pm 3$ (ppm)	✓	✓
PREx	A	March 10	1.056	50	$^{208}\text{Pb}$ (0.5 mm)	$500 \pm 15$ (ppb)	$100 \pm 10$ (ppb)	2
QWeak	C	May 10	1.162	180	$^1\text{H}$ (35 cm)	$234 \pm 5$ (ppb)	$100 \pm 10$ (ppb)	2

# Higher Voltage & the “Inverted” Gun for QWeak

- Now, we are running at 100 kV
- To reduce space charge emittance blow-up at higher current, we are increasing the gun voltage up to 150 kV
  - Beam quality, including transmission thru Injector, improves at higher gun voltage

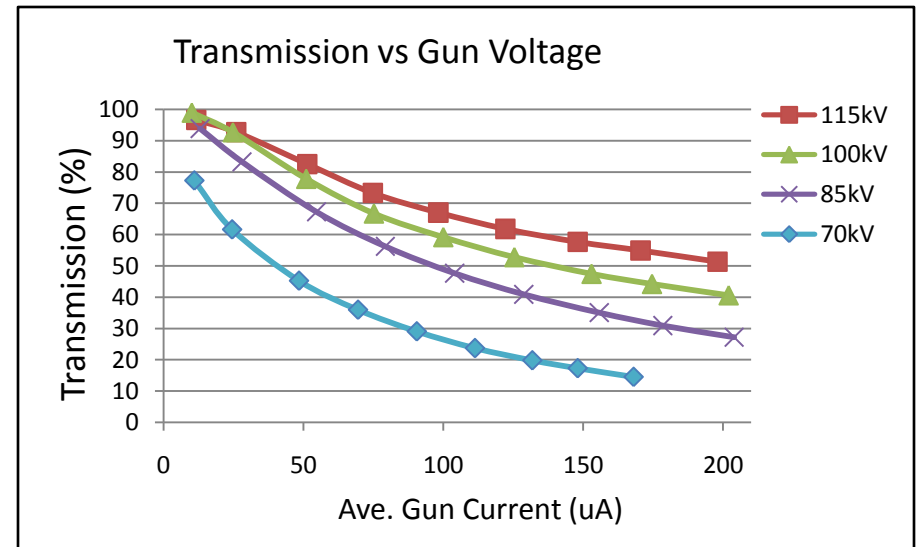
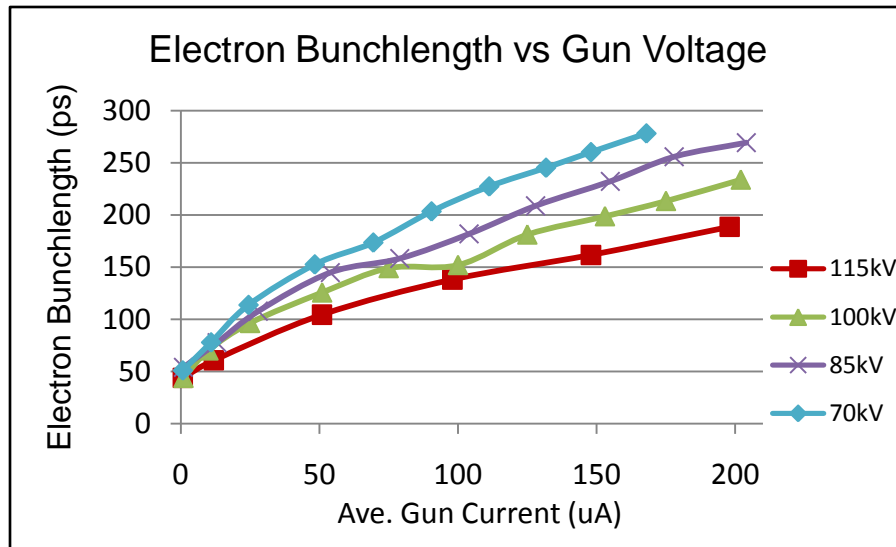

- Problem: Field emission at higher voltage degrades lifetime → solution: Inverted Gun
- Inverted Gun will be installed in July 2009

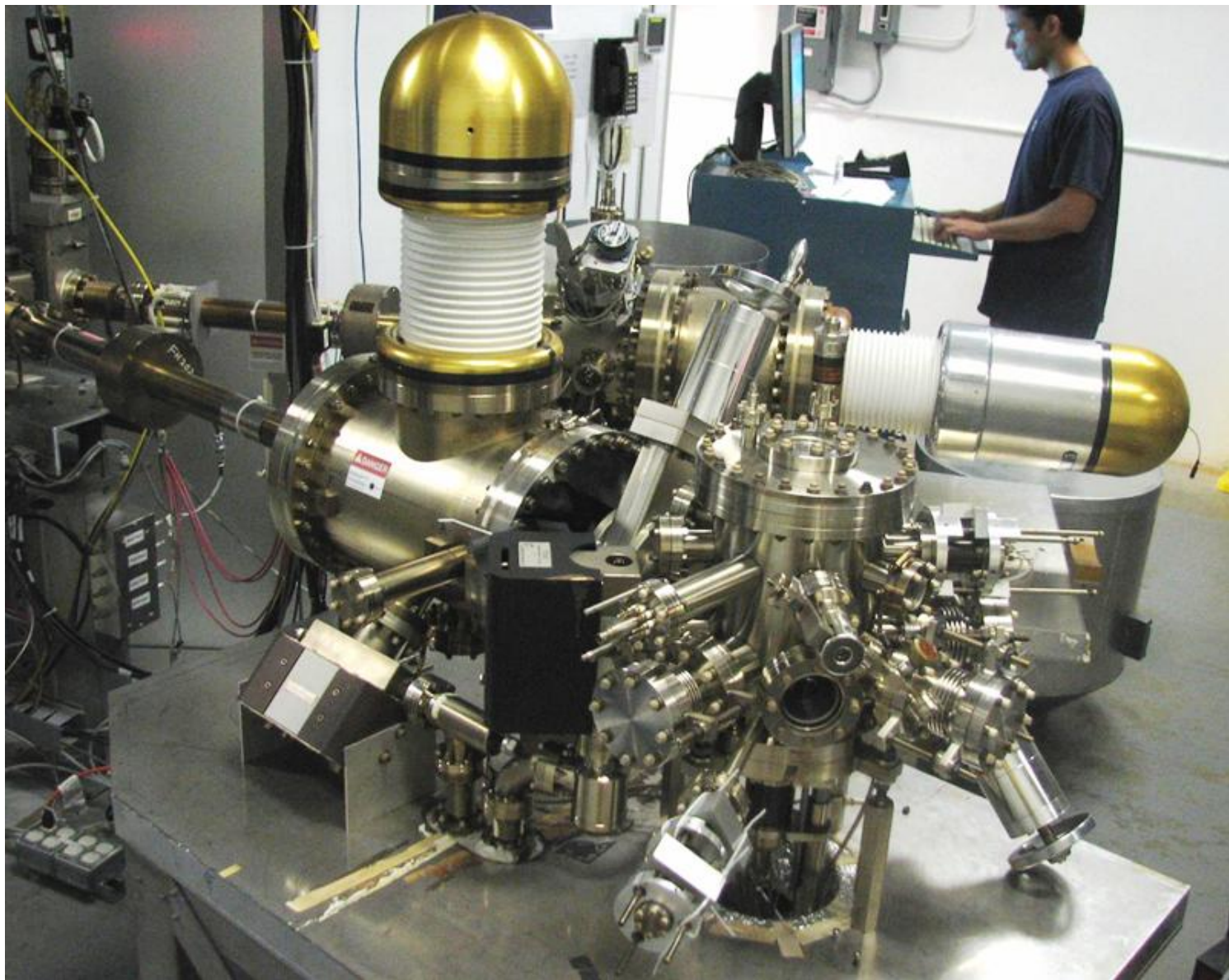

Want to move away from “conventional” insulator used on all GaAs photo-guns today: expensive, months to build, prone to damage from field emission.

Medical x-ray  
technology



Present Ceramic  
Exposed to field emission  
Large area  
Expensive (\$50k)

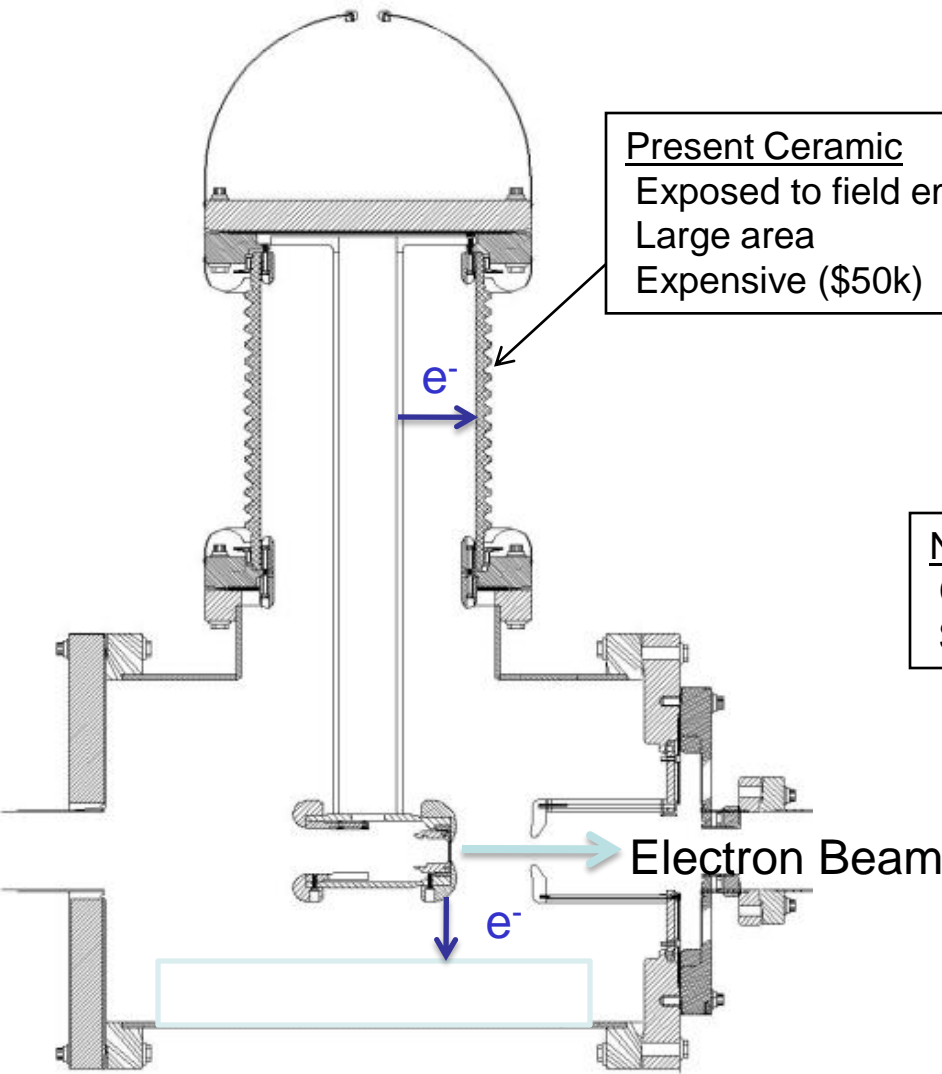

New Ceramic  
Compact  
\$5k

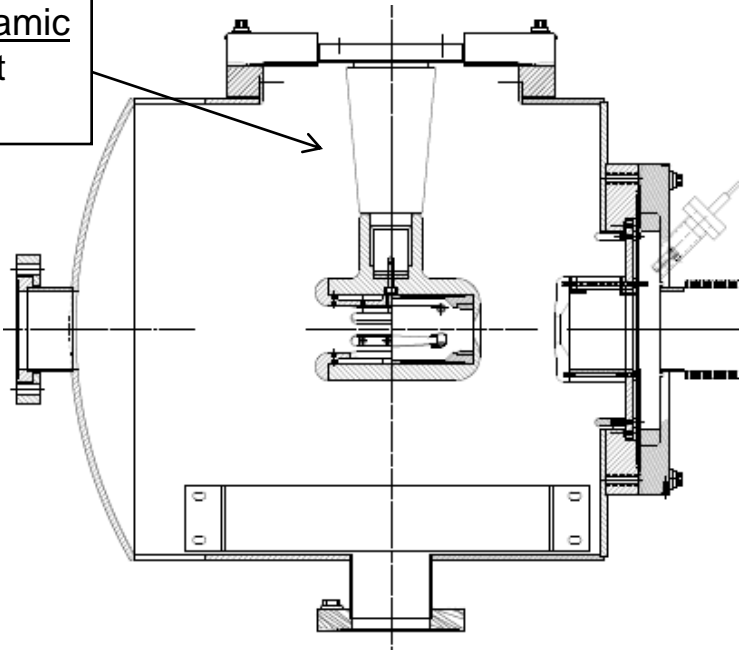



Inverted Gun

# Two Wien Filters Slow Helicity Reversal for PREx

- Now, we have available Insertable Half Wave Plate (IHWP) slow helicity reversal of laser polarization:
  - I. Cancels Electronic cross talk and Pockels Cell Steering
  - II. Residual Linear polarization effects do not cancel
- New: Slow helicity reversal of electron polarization using two Wien Filters and solenoid:
  - I. Solenoid rotates spin by +/- 90 (spin rotates as B, but focus as B<sup>2</sup>)
    - Maintain constant Injector and Accelerator configuration
  - II. Cancels most helicity-correlated beam asymmetries from the source including spot size
  - III. Can be used up to maximum voltage of 140 kV



 + Solenoid current  
 - Solenoid current

January 2010

July 2009

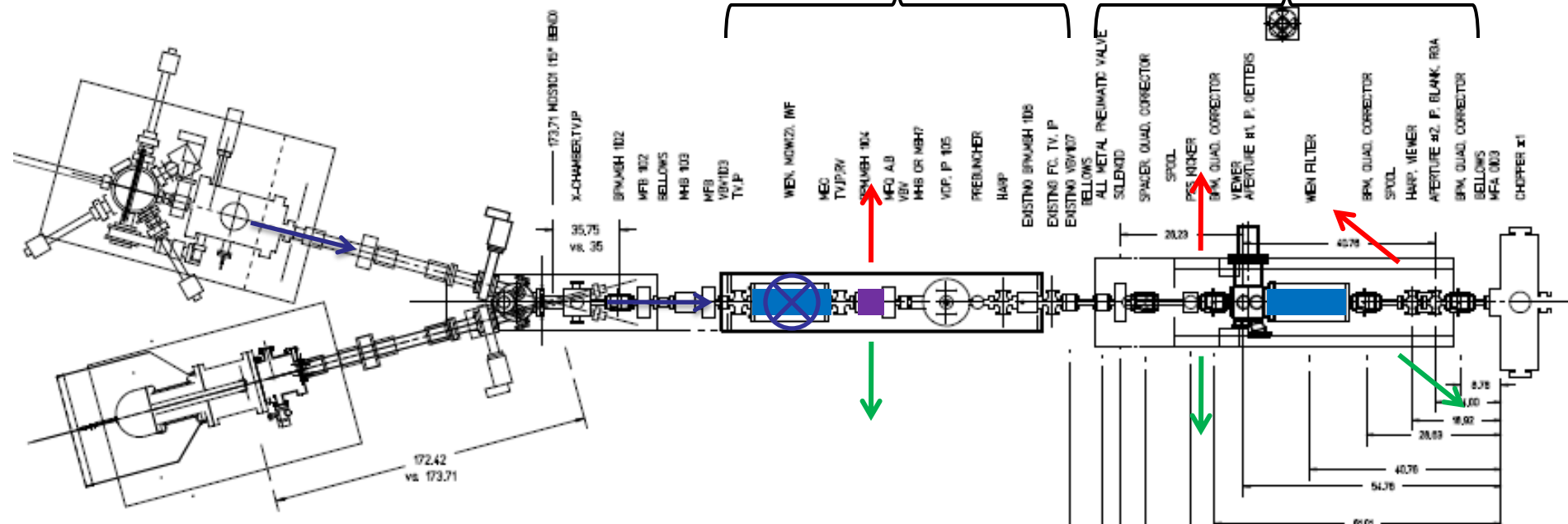

“Spin Flipper”

Vertical Wien =  $90^\circ$

Azimuthal Solenoid =  $\pm 90^\circ$

“Long. Pol. for Halls”

Horizontal Wien =  $\{-90^\circ, +90^\circ\}$

# Fast Helicity Reversal

- We have been using 30 Hz helicity reversal:
  - Power line 60 Hz frequency is major source of noise in parity experiments
  - For 30 Hz reversal,  $T_{\text{Stable}}$  (= 33.333 ms) contains exactly two cycles of 60 Hz line noise → this reversal cancels line noise
- Problem:
  - There are other sources of noise at low frequencies, *i.e.*, target density fluctuations, beam current fluctuations
    - Cause larger widths of helicity correlated distributions, double-horned distributions
- Solution: Use fast helicity reversal (faster than 30 Hz)
- Studied beam properties at 1 kHz (Oct 2008 – April 2009)
  - Note: Fast reversal of the helicity Pockels Cell was possible using newly designed optically-driven fast high voltage switch



- Widths at 30 Hz and 1 kHz

Note: For statistical (white) noise, the increase in width going from 30 Hz to 1 kHz is:  $\sqrt{\frac{33.333}{0.980}} = 5.8$

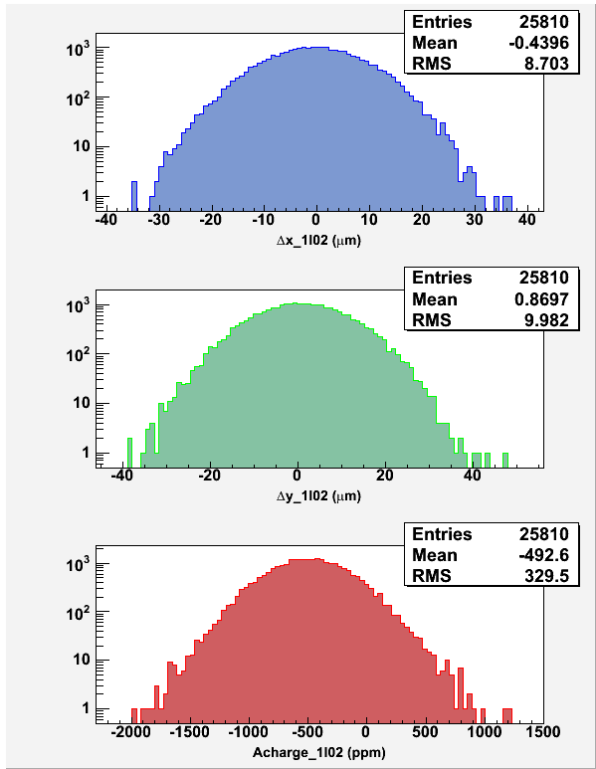
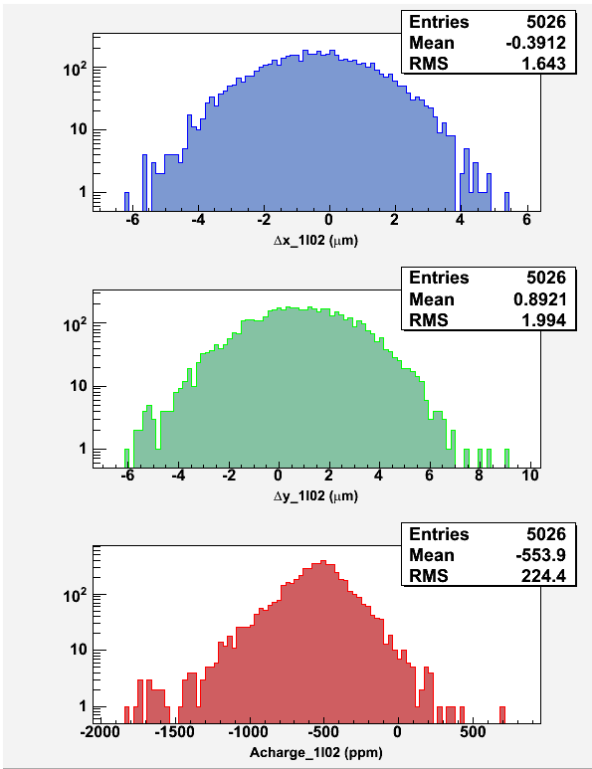

**30 Hz,  $T_{\text{Stable}} = 33.333$  ms,  
 $T_{\text{Settle}} = 500$   $\mu\text{s}$**

**1 kHz,  $T_{\text{Stable}} = 0.980$  ms,  
 $T_{\text{Settle}} = 60$   $\mu\text{s}$**

# ○ Summary of Fast Helicity Reversal Studies

## ➤ Fast Helicity Reversal is needed:

- I. Huge reduction of noise from target density fluctuations
- II. Reduces noise on beam current by factor of 3
- III. Reasonable reduction in beam position noise

## ➤ T<sub>Settle</sub> of 60 μs is very reasonable

## ➤ Future Parity Experiment:

Experiment	Frequency	Clock	Pattern
HAPPE <sub>x</sub> III & PVDIS	30 Hz	Line-Locked	Quartet
PRE <sub>x</sub>	240 Hz	Line-Locked	Octet
QWeak	1 kHz	Free	Quartet

## ➤ New Helicity Board to be installed in July 2009

# Helicity Magnets for Position Feedback

- There are four magnets in the 5 MeV region: two horizontal and two vertical
- Can do feedback on both position and angle in x & y
- Each magnet can kick both helicity states
- Do not change charge asymmetry (unlike PZT)
  - The position feedback is not coupled to the charge feedback

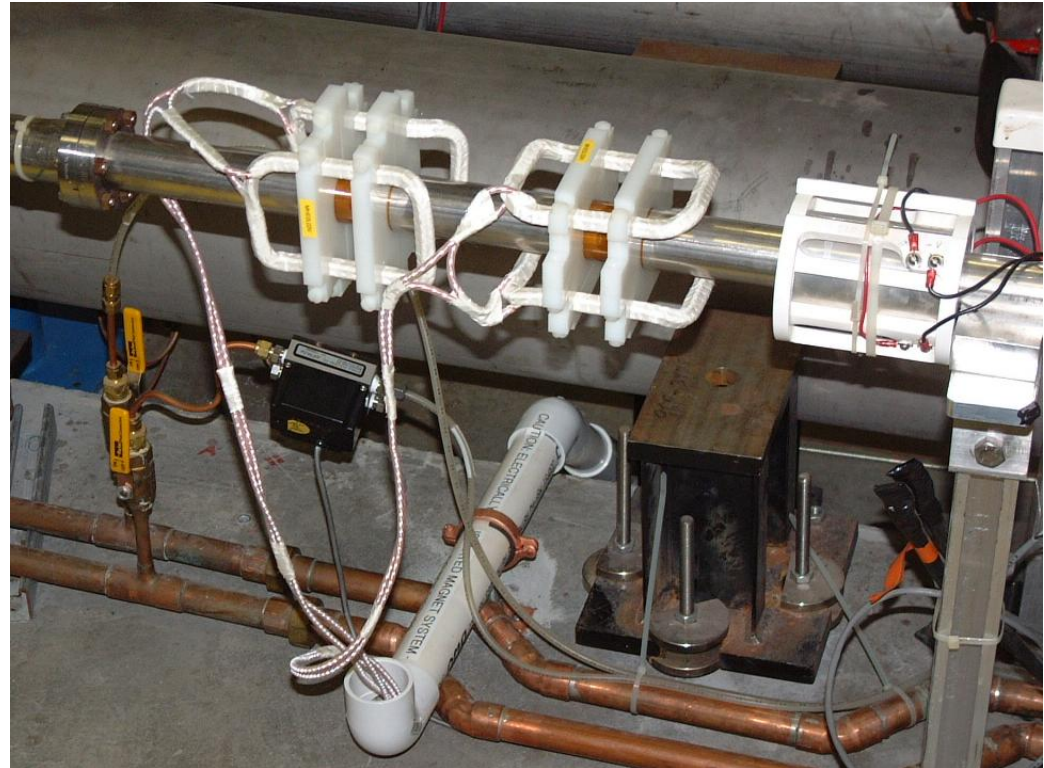

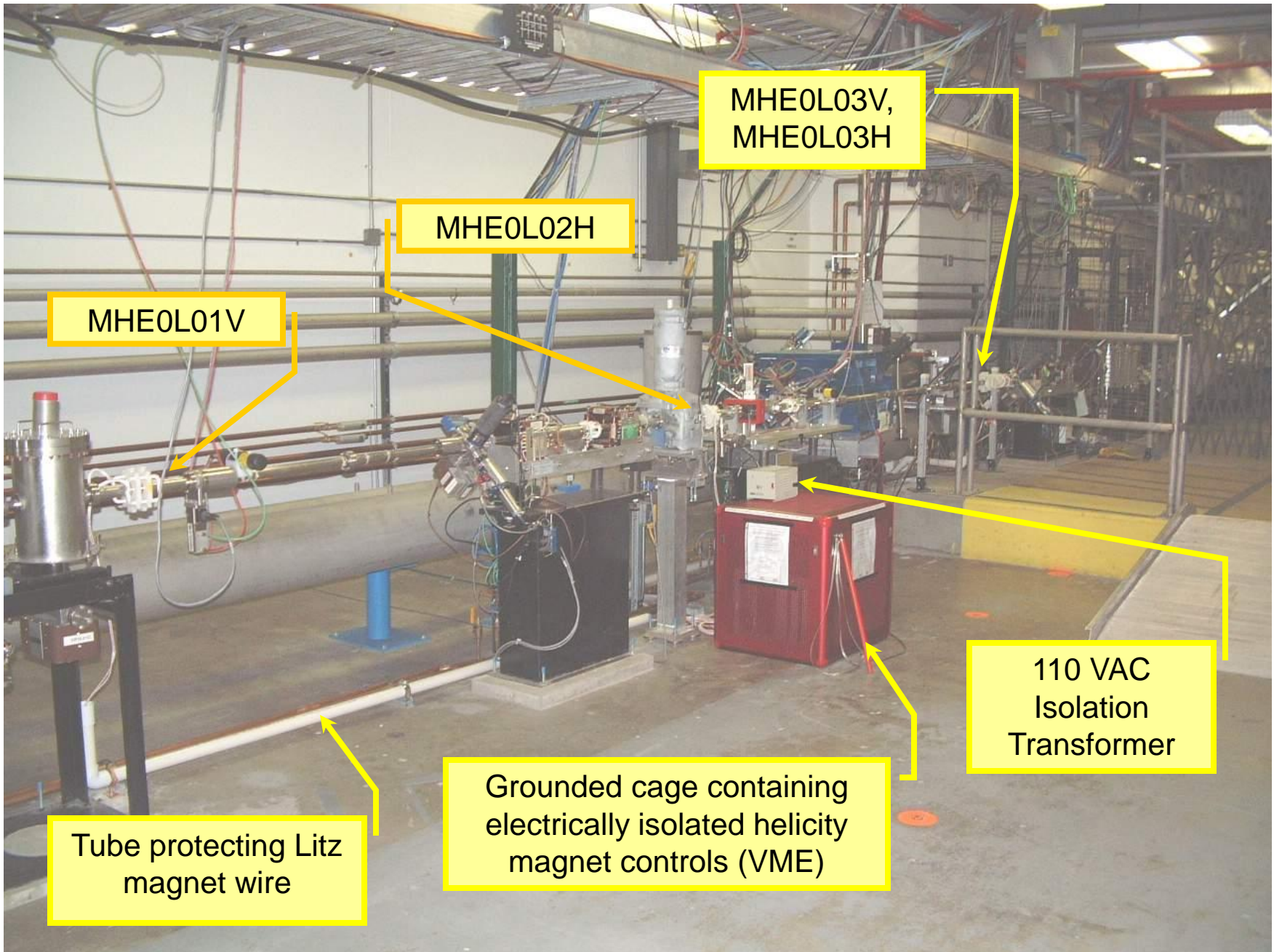

MHE0L03V,  
MHE0L03H

MHE0L02H

MHE0L01V

Tube protecting Litz  
magnet wire

Grounded cage containing  
electrically isolated helicity  
magnet controls (VME)

110 VAC  
Isolation  
Transformer

# ○ Position Feedback Test:

- Introduce large position differences: Move the Pockels Cell from its optimal position on the laser table

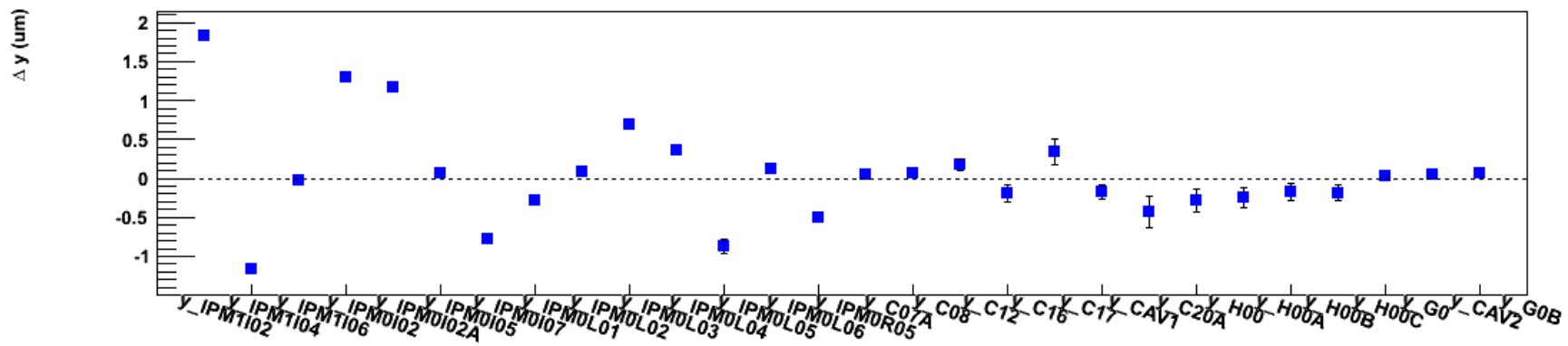
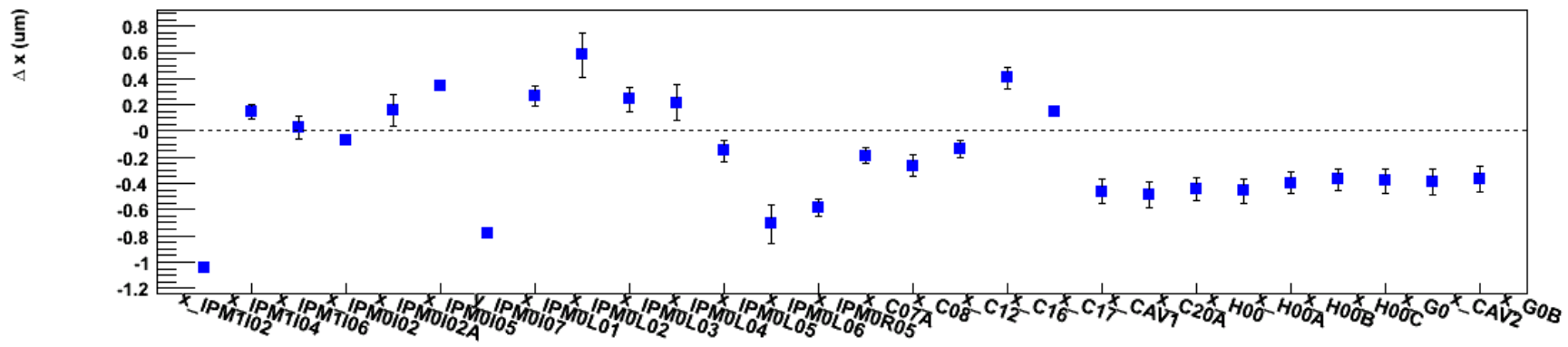



➤ Turn ON position feedback: Zero position differences in Injector at 0L05 and 0L06

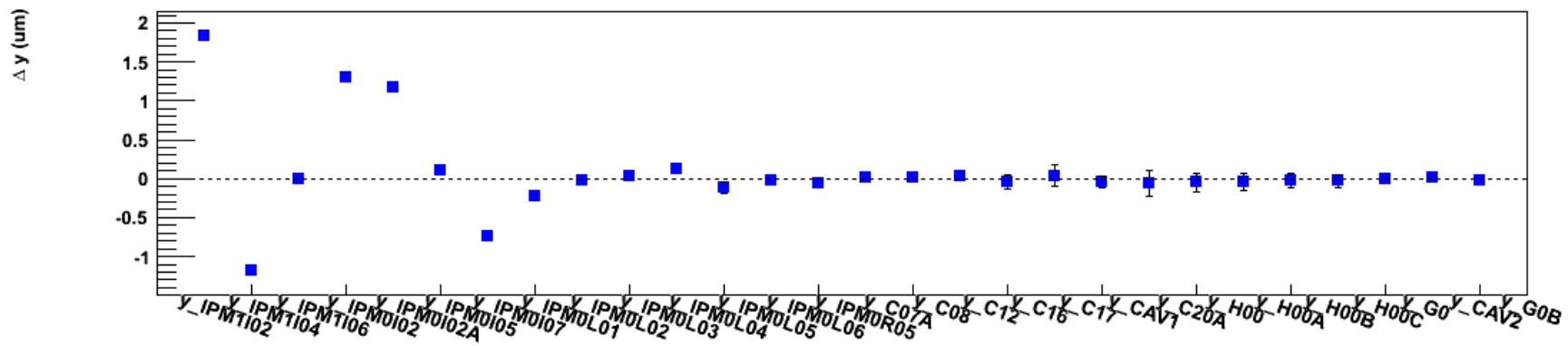
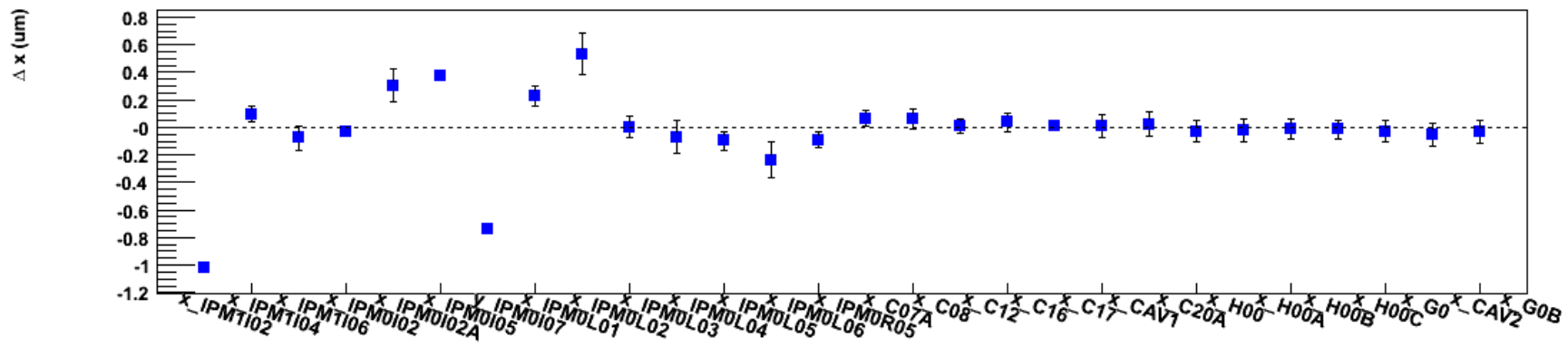

○ One big concern:  
Will other  
elements on the  
beam-line see the  
helicity signal?

➤ Check for electrical pick-  
up with Pockels Cell OFF  
and Turn ON magnet 1

➤ Power it to 1000 times its  
operational value. Look  
for position differences  
upstream the magnet

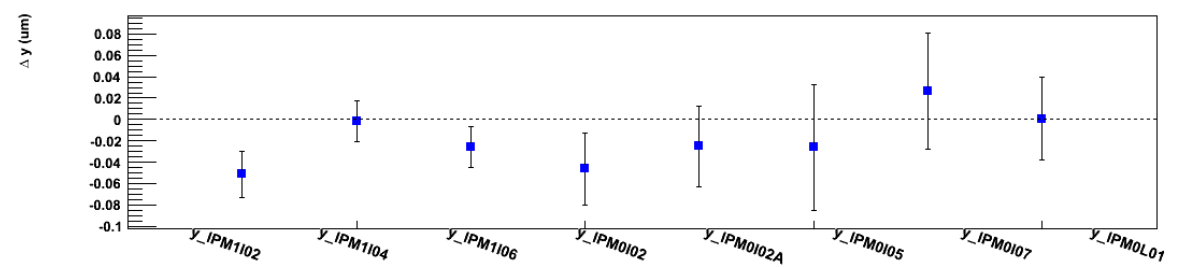
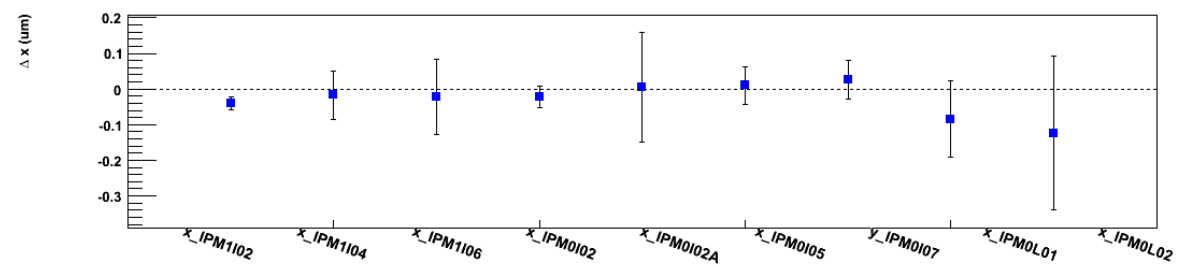
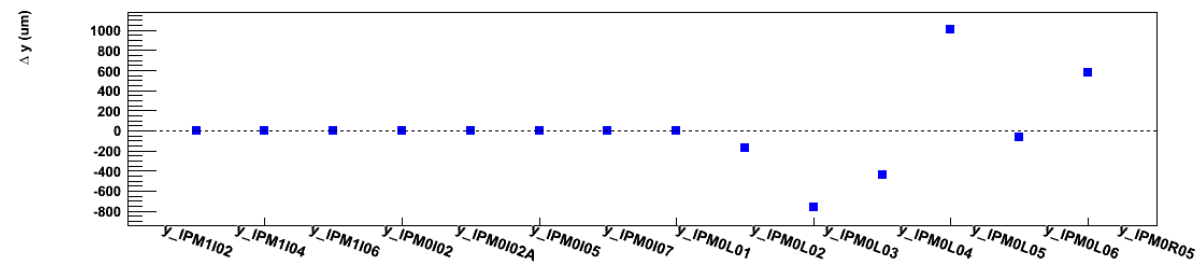
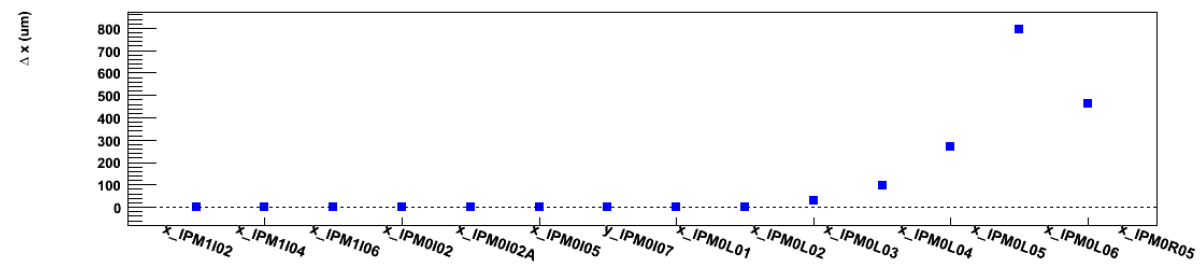



# Other Developments

- Ability to do Charge Feedback using either PITA or IA or IA with the option to correct for Pockels Cell hysteresis
- Cleanup Insertable Linear Polarizer before the Pockels Cell is available
- Pockels Cell is equipped with remote controlled x & y translational stage for minimizing position differences while measuring the position differences of electron beam
- With Load-Locked Gun, now we can zero the offset term in the charge asymmetry caused by the vacuum window birefringence by rotating the photocathode ... see next slide ...

# Photocathode Rotation

- Measure Offset term as a function of photocathode angle ( $\theta_c$ )
- Choose angle where Offset is zero

