

Measurement of $^{16}\text{O}(\gamma, \alpha)^{12}\text{C}$ with a Bubble Chamber
and a Bremsstrahlung Beam at Jefferson Lab Injector

Riad Suleiman
January 9, 2014



B. DiGiovine
D. Henderson
R. J. Holt
K. E. Rehm



THE UNIVERSITY OF
CHICAGO

A. Robinson
C. Ugalde



A. Sonnenschein



J. Benesch
P. Degtiarenko
A. Freyberger
J. Grames
R. Kazimi
G. Kharashvili
D. Meekins
M. Poelker
Y. Roblin
R. Suleiman
V. Vylet

OUTLINE

- Nucleosynthesis and the $^{12}\text{C}(\alpha,\gamma)^{16}\text{O}$ Reaction
- Time-reversal Reaction: $^{16}\text{O}(\gamma,\alpha)^{12}\text{C}$
- Bubble Chamber Theory and Design
- Work at HIGS
- Experimental Setup at Jefferson Lab Injector
- Bremsstrahlung Beam and Penfold-Leiss Unfolding
- Statistical and Systematic Errors
- Backgrounds and Ion Energy Distributions
- Safety
- Summary and Outlook

RELATIVE ABUNDANCE OF ELEMENTS BY WEIGHT

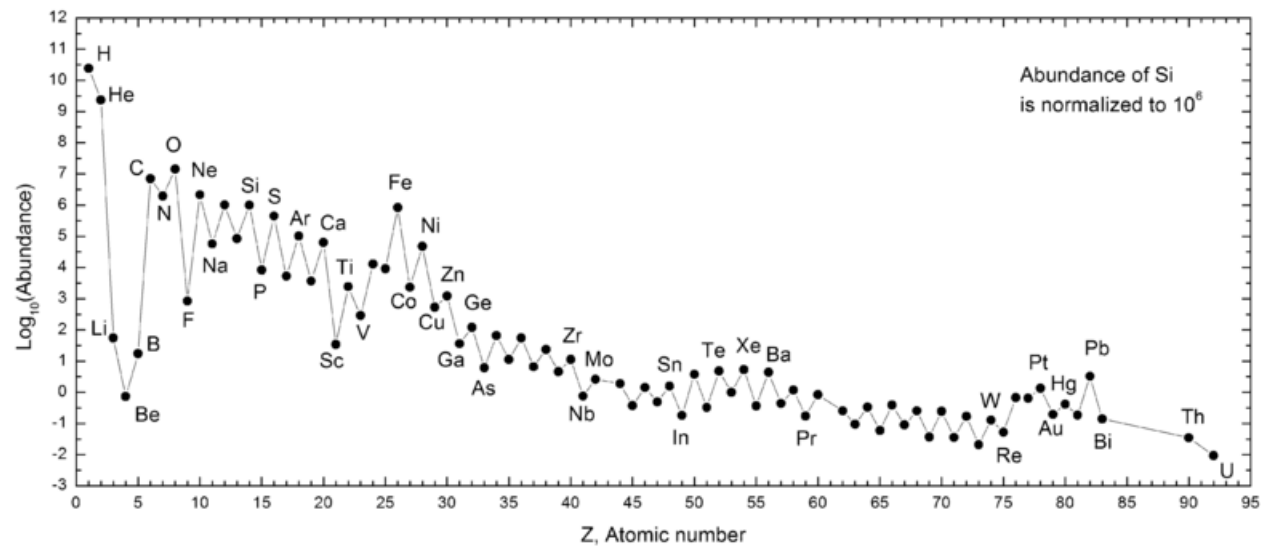
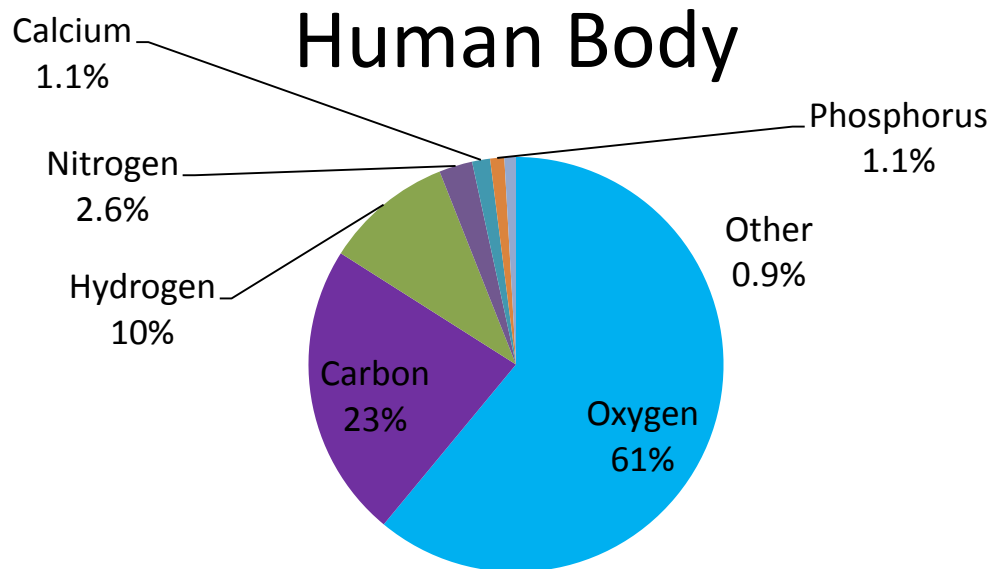
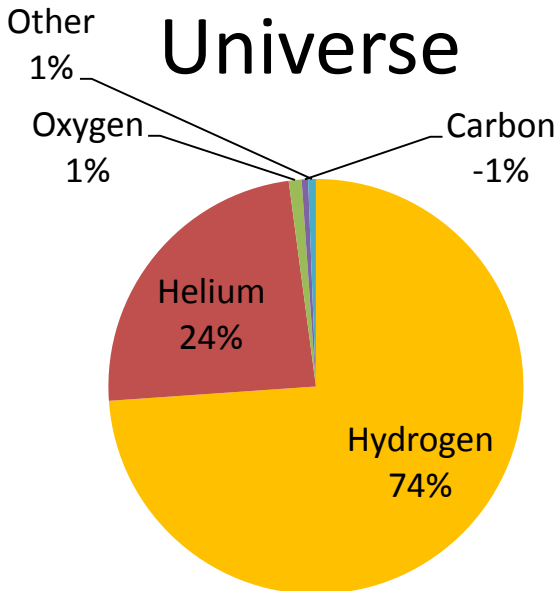

STELLAR HELIUM BURNING

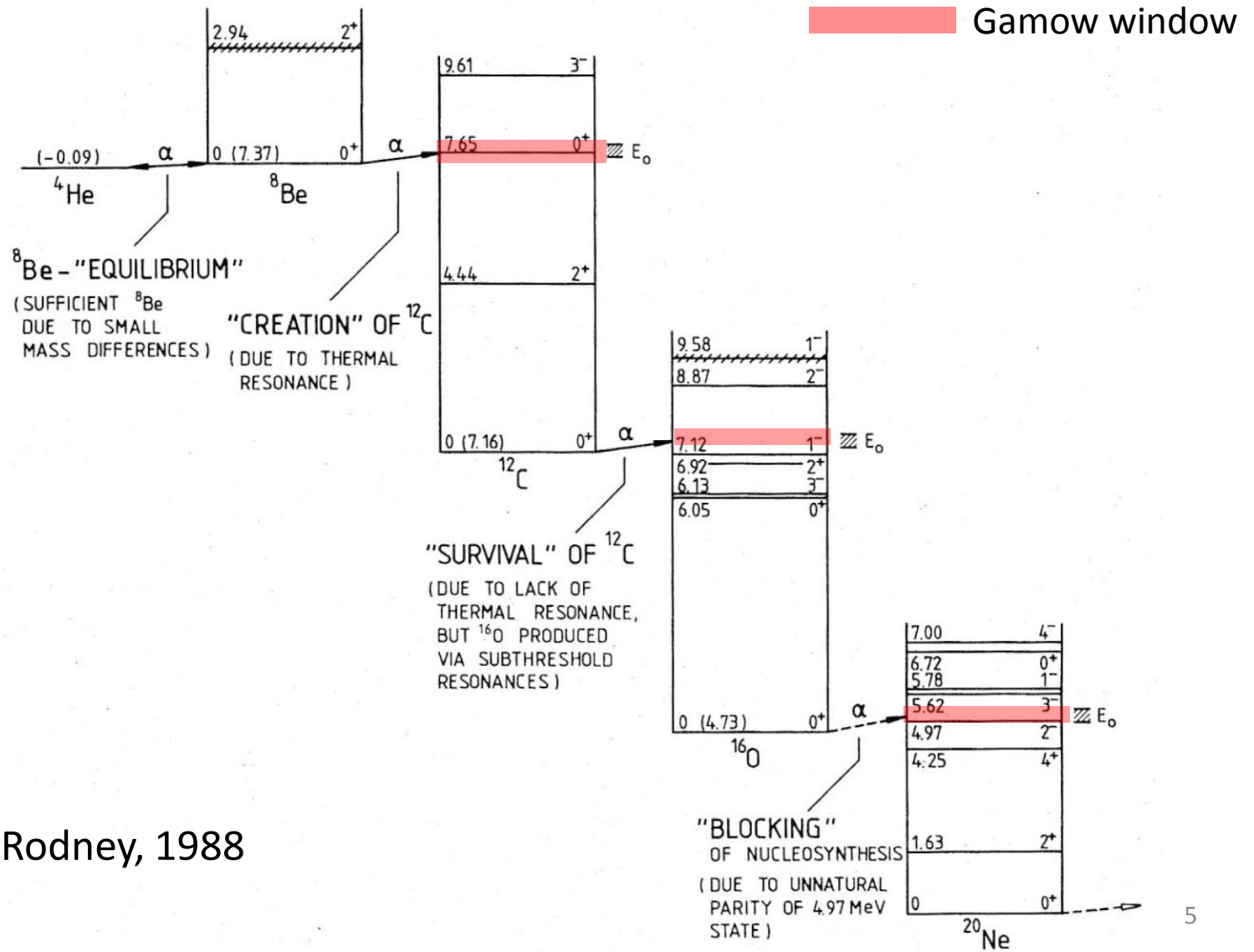

Rolfs and Rodney, 1988

THE $^{12}\text{C}(\alpha,\gamma)^{16}\text{O}$ Reaction

- The “holy grail” of nuclear astrophysics

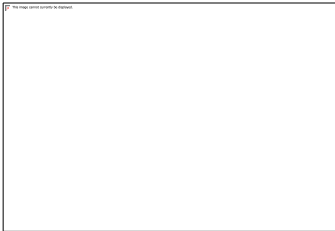

Affects the synthesis of most of the elements of the periodic table

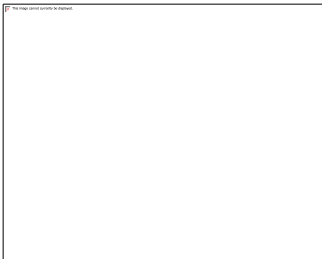

Sets the C to O ratio in the universe



Determines the minimum mass a star requires to become a supernova

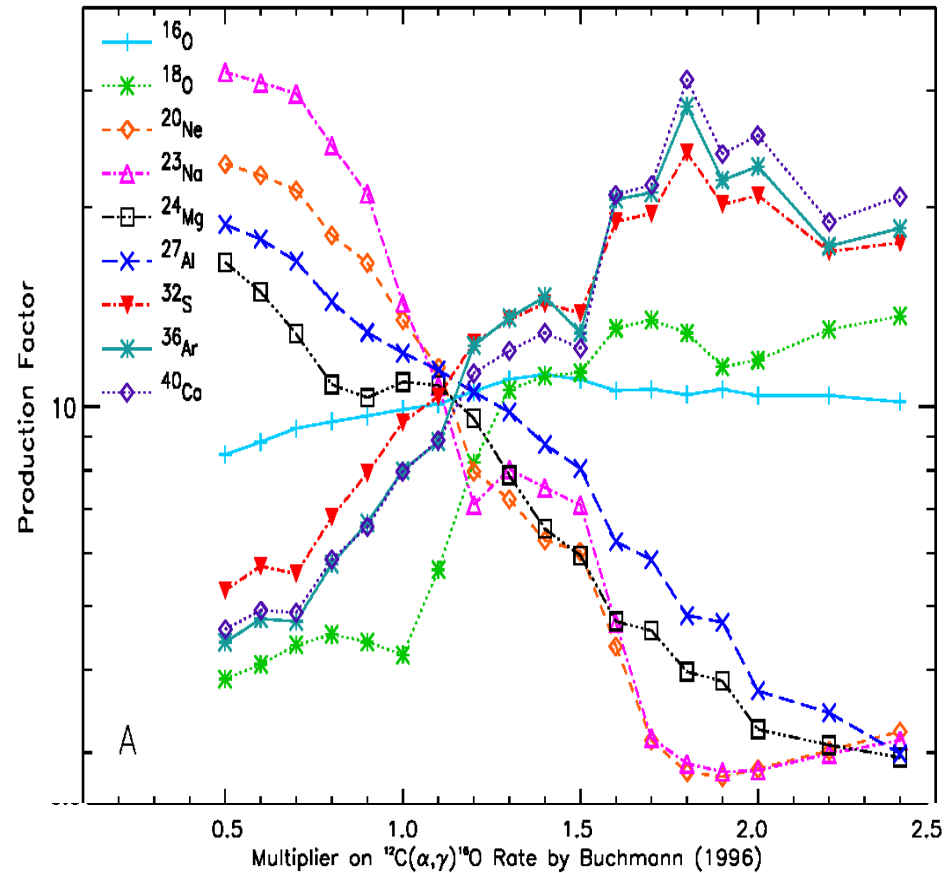

STELLAR CARBON BURNING

- Helium burning stage of stellar evolution occurs at $T=10^9$ K
- Most effective stellar energy, $E_{CM} = 0.3$ MeV
- He burning at cross section $\sigma \sim 10^{-17}$ barn

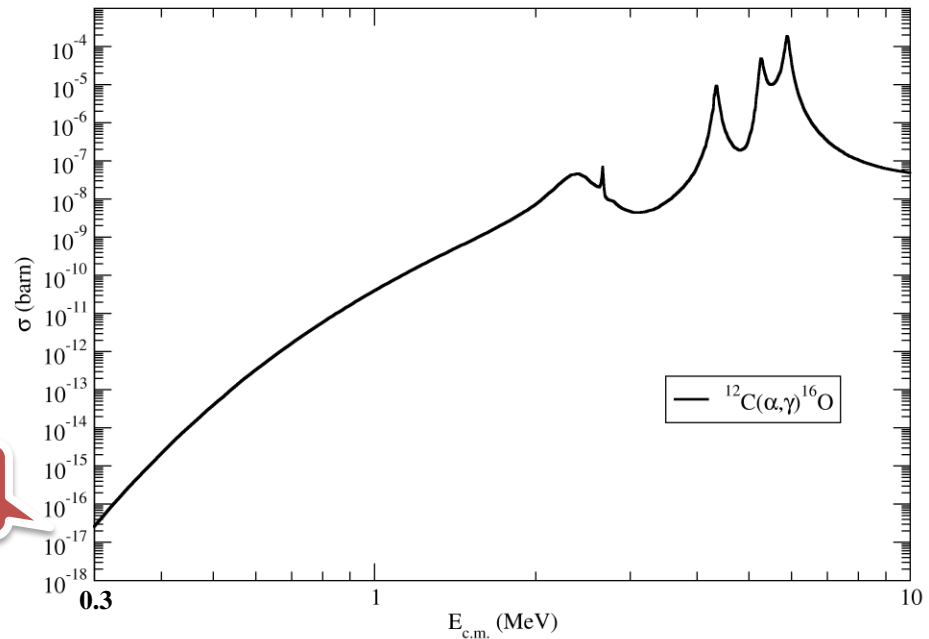

Stellar Energy

$$N_A \langle \sigma v \rangle = N_A \sqrt{\frac{8}{\pi m (kT)^3}} \int_0^\infty S(E) E \exp\left(-\frac{E}{kT}\right) dE$$

ENERGY LEVEL-DIAGRAM OF ^{16}O

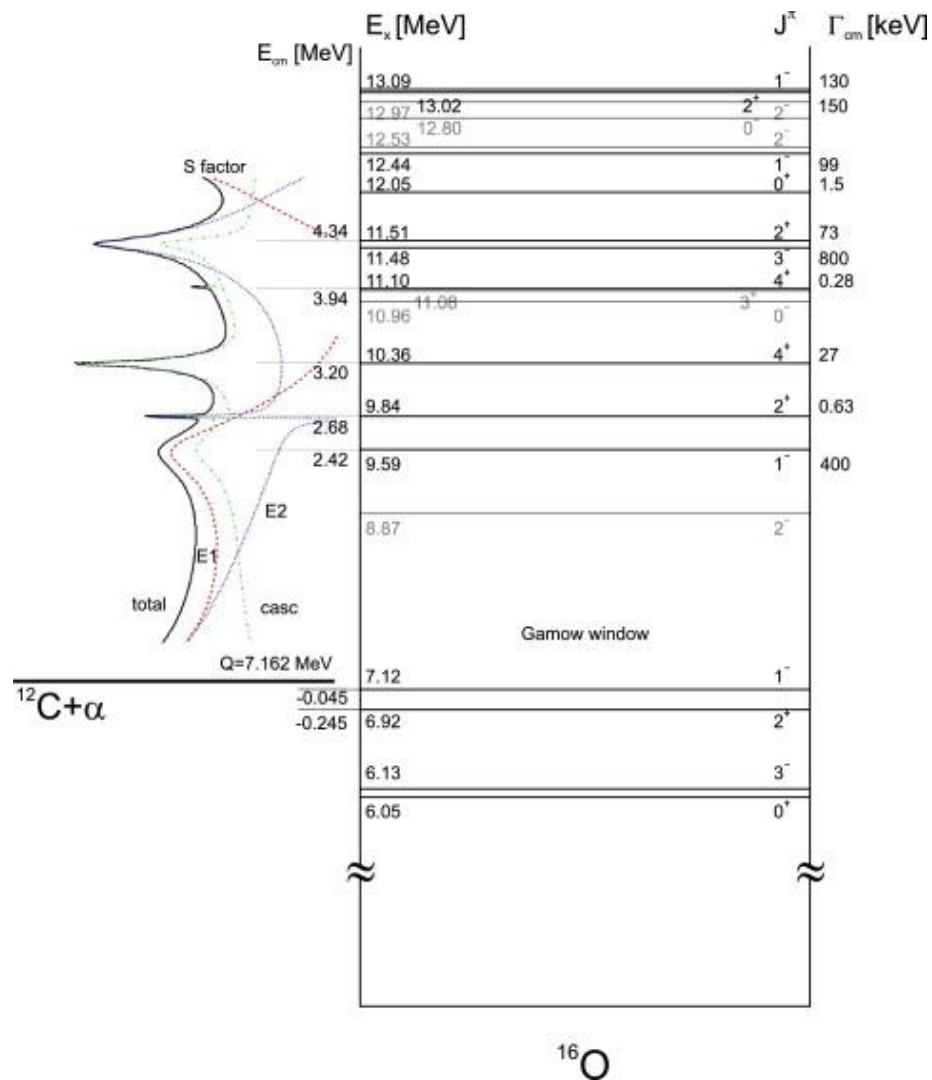

No Resonances but
interferences

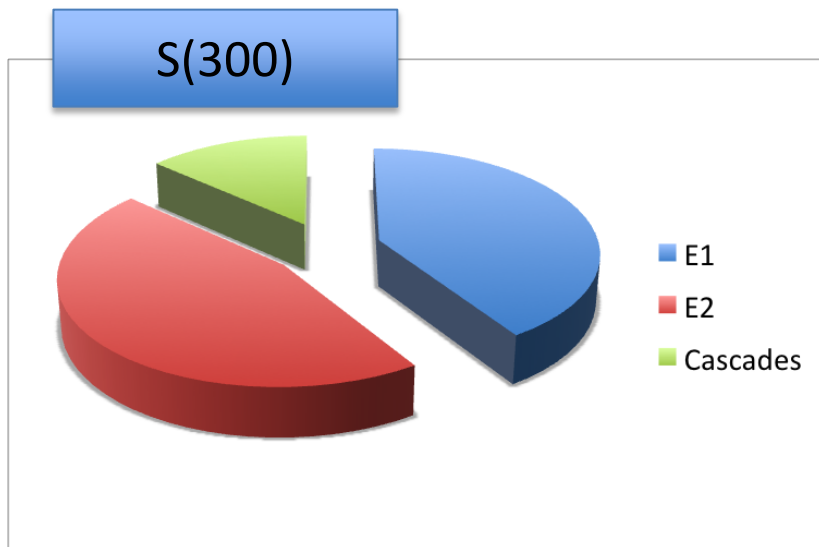

Kunz 2001, Matei 2006

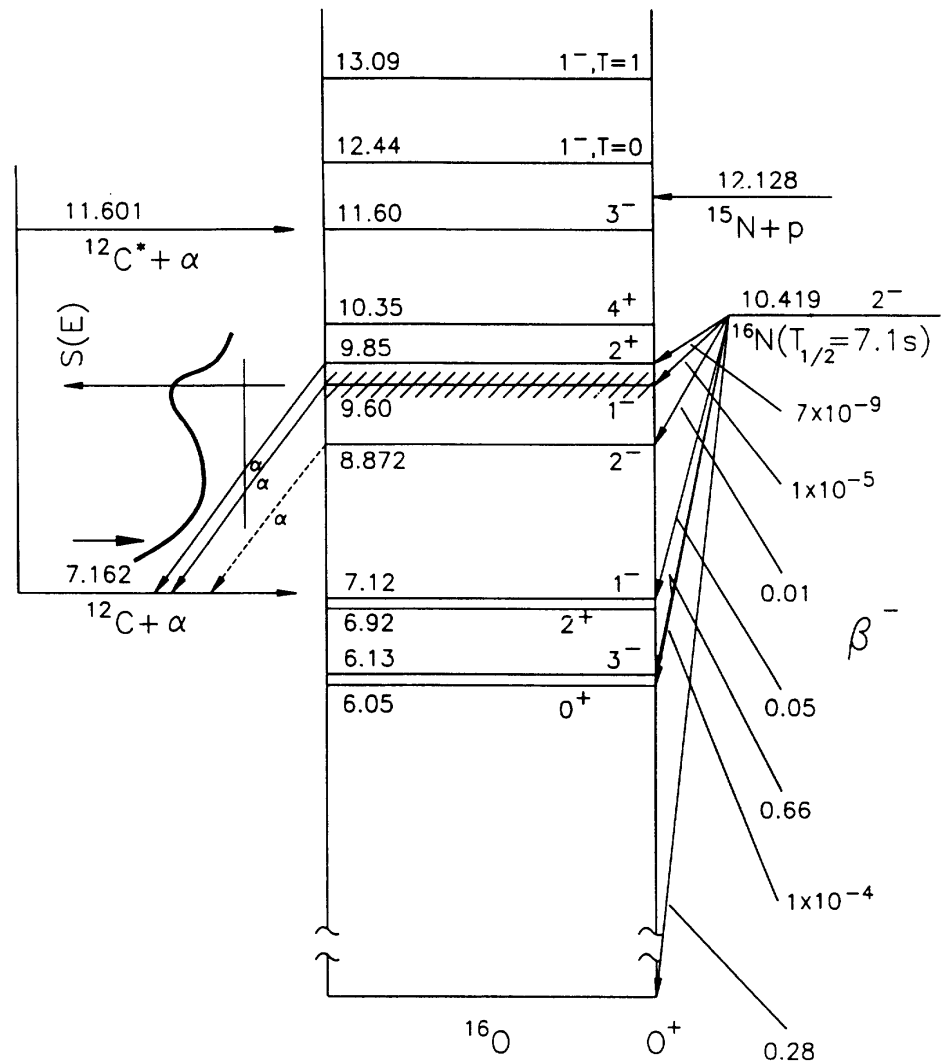

FIG. 1. Partial energy-level diagram for ^{16}O (adapted from [4]).

Heroic efforts in search of the holy grail of astrophysics: $^{12}\text{C}(\alpha, \gamma)^{16}\text{O}$

Luminosity $\sim 1\text{E}34 \text{ cm}^{-2}\text{s}^{-1}$

Efficiency $\sim 1\text{E}-3$

$^{16}\text{O}(\gamma, \alpha)^{12}\text{C}$

Lum(HIγS) $\sim 4\text{E}30 \text{ cm}^{-2}\text{s}^{-1}$

Lum(JLab) $\sim 8\text{E}31 \text{ cm}^{-2}\text{s}^{-1}$

10 μA , top 100 keV

$\lambda_{\gamma}^2/\lambda_{\alpha}^2 \sim 60$

Bubble chamber: solid angle x efficiency = 100%

Expt	Beam current (mA)	Detector Effic. (%)	Target	Meas. Time (h)
Redder	0.7	Ge, 35	^{12}C , $\sim 3\text{E}18$	900
Ouellet	0.03	Ge, 30	^{12}C , $5\text{E}18$	1950
Roters	0.02	BGO, 270	^4He , $1\text{E}19$	5000
Kunz	0.45	Ge, 100	^{12}C , $3\text{E}18$	700
EUROGA M	0.34	Ge, 70	^{16}O , $1\text{E}19$	2100

$^{12}\text{C}(\alpha, \gamma)^{16}\text{O}$

$^4\text{He}(\alpha, \gamma)^{16}\text{O}$

ASTROPHYSICAL S-FACTOR $^{12}\text{C}(\alpha,\gamma)^{16}\text{O}$

$$S = E_{CM} \sigma(\alpha, \gamma) e^{2\pi\eta}$$

$$\eta = \frac{1}{137} Z_{\alpha} Z_{^{12}\text{C}} \sqrt{\frac{m_{^{12}\text{C}\alpha}}{2E_{CM}}}$$

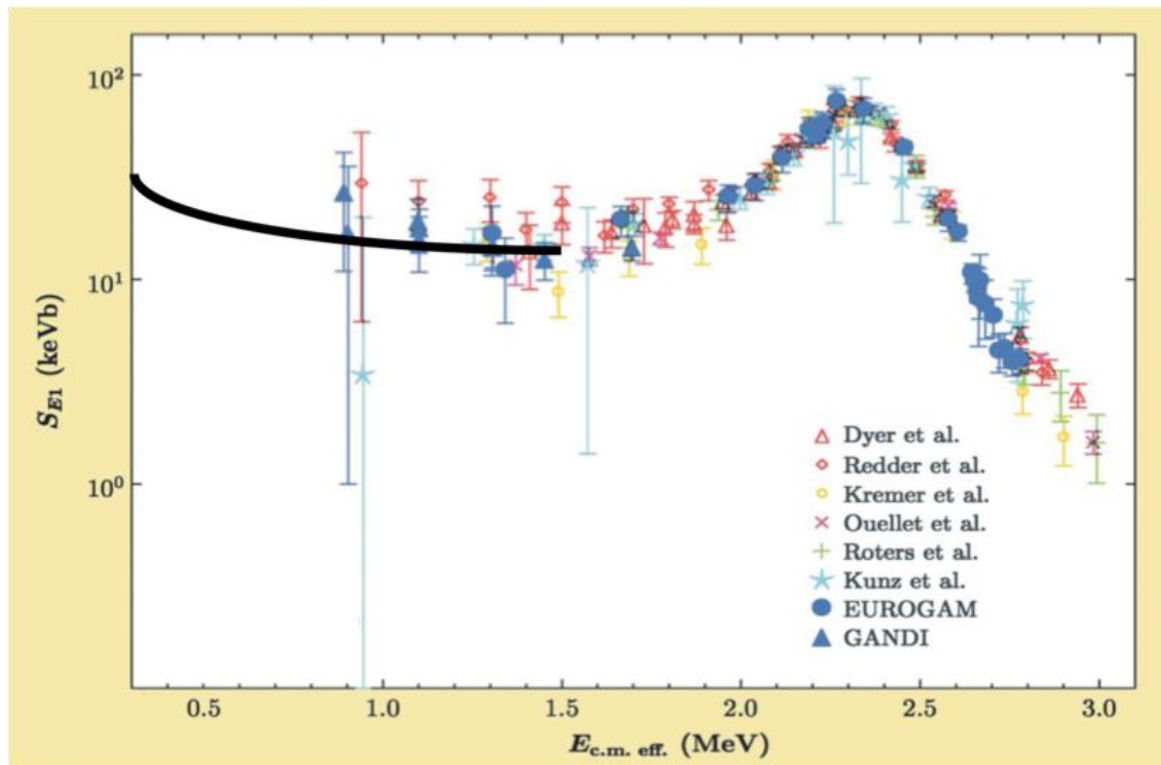

Author	S(300keV) (keV-b)
Buchmann (2005)	102-198
Caughlan and Fowler (1988)	120-220
Hammer (2005)	162+-39

Stellar helium burning at E=300 keV

TIME REVERSAL REACTION

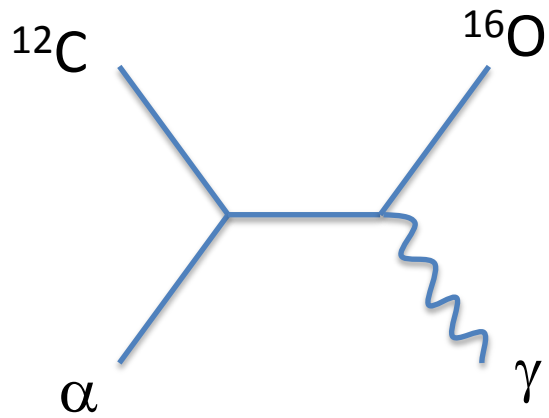

$$\omega_A \frac{\sigma_A(X, \gamma)}{\lambda_\alpha^2} = \omega_B \frac{\sigma_B(\gamma, X)}{\lambda_\beta^2}$$

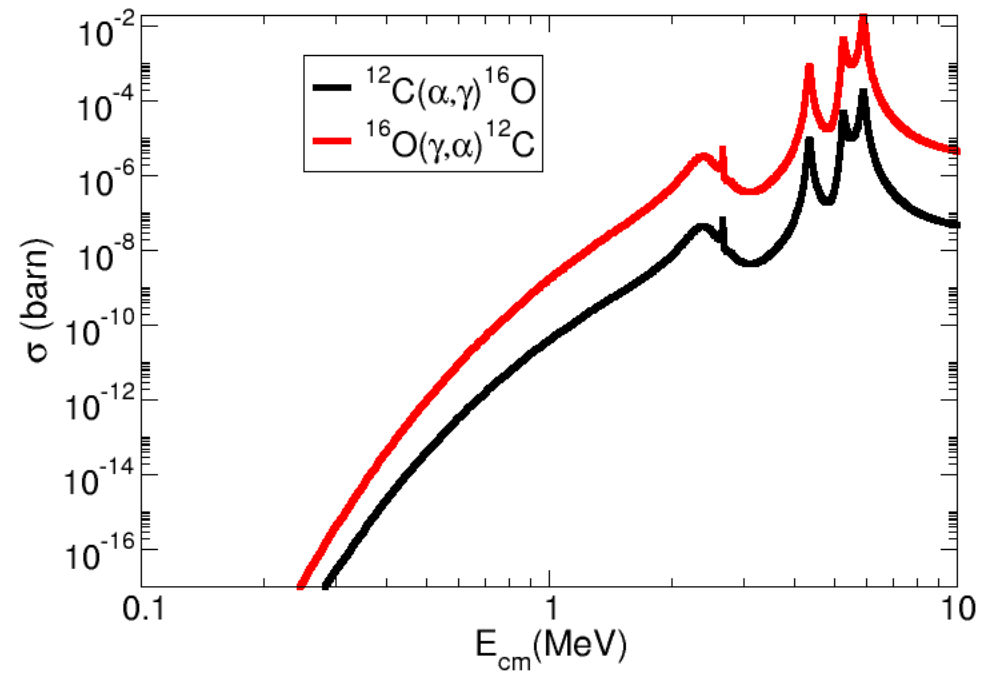

(γ, α) and (α, γ) – Reciprocity Relation

- $A(\alpha, \gamma)B$:

$$\sigma_{B\gamma}^{j \rightarrow i}(E_\gamma) = \frac{(2J_i + 1)(2J_\alpha + 1)}{2J_j + 1} \frac{m_{A\alpha} c^2 E_{A\alpha}}{E_\gamma^2} \sigma_{A\alpha}^{i \rightarrow j}(E_{A\alpha})$$

$$m_{A\alpha} c^2 = \frac{M(^{12}\text{C}) \cdot M(\alpha)}{M(^{12}\text{C}) + M(\alpha)} = 2796 \text{ MeV}$$

$$J_i = 0, J_j = 0, J_\alpha = 0 \quad E_{A\alpha} = E_{CM} = \frac{M(^{12}\text{C})}{M(^{12}\text{C}) + M(\alpha)} E_\alpha$$

$$E_{CM} = \sqrt{m_B^2 + 2E_\gamma m_B} - m_B - Q$$



$$\sigma_{(\gamma, \alpha)}(E_\gamma) = \frac{m_{A\alpha} c^2 E_{CM}}{E_\gamma^2} \sigma_{(\alpha, \gamma)}(E_{CM})$$

- $\sigma(\gamma, \alpha)$ is over two orders of magnitude larger than $\sigma(\alpha, \gamma)$

NEW APPROACH: INVERSE REACTION + BUBBLE CHAMBER

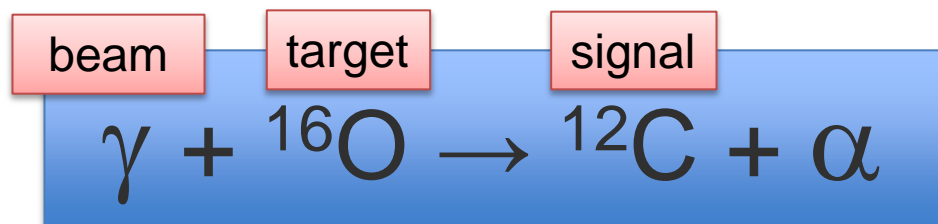

Monochromatic γ beam at HI γ S
 $\sim 10^{7-8}$ γ/s

Bremsstrahlung at JLab
 $\sim 4 \times 10^9$ γ/s (top 250 keV)

- Extra gain (x100) by measuring time inverse reaction
- Target density up to $\times 10^6$ higher than conventional targets
- Superheated liquid will nucleate from α and ${}^{12}\text{C}$ recoils
- Electromagnetic debris (degraded electrons and gammas, or positrons) that escape the collimator/electron beam do NOT trigger nucleation (detector is insensitive to γ -rays by at least 1 part in 10^{11}).

BUBBLE CHAMBER THEORY AND DESIGN

- Donald Glaser, 86, won Nobel for inventing chamber to detect subatomic particles (1960)

- Dark Matter
- COUPP F
- PICASSO
- SIMPLE P

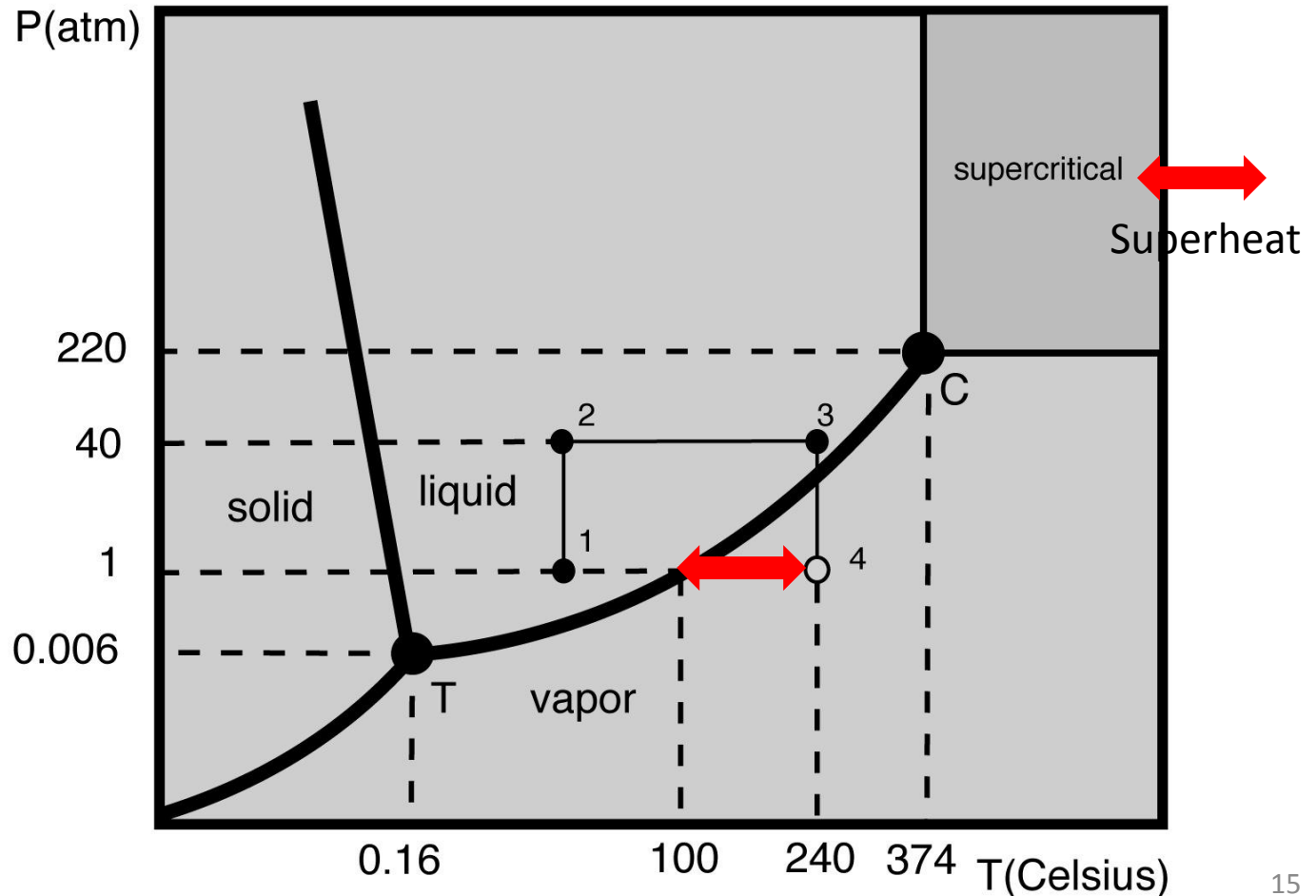

BUBBLE GROWTH AND QUENCHING

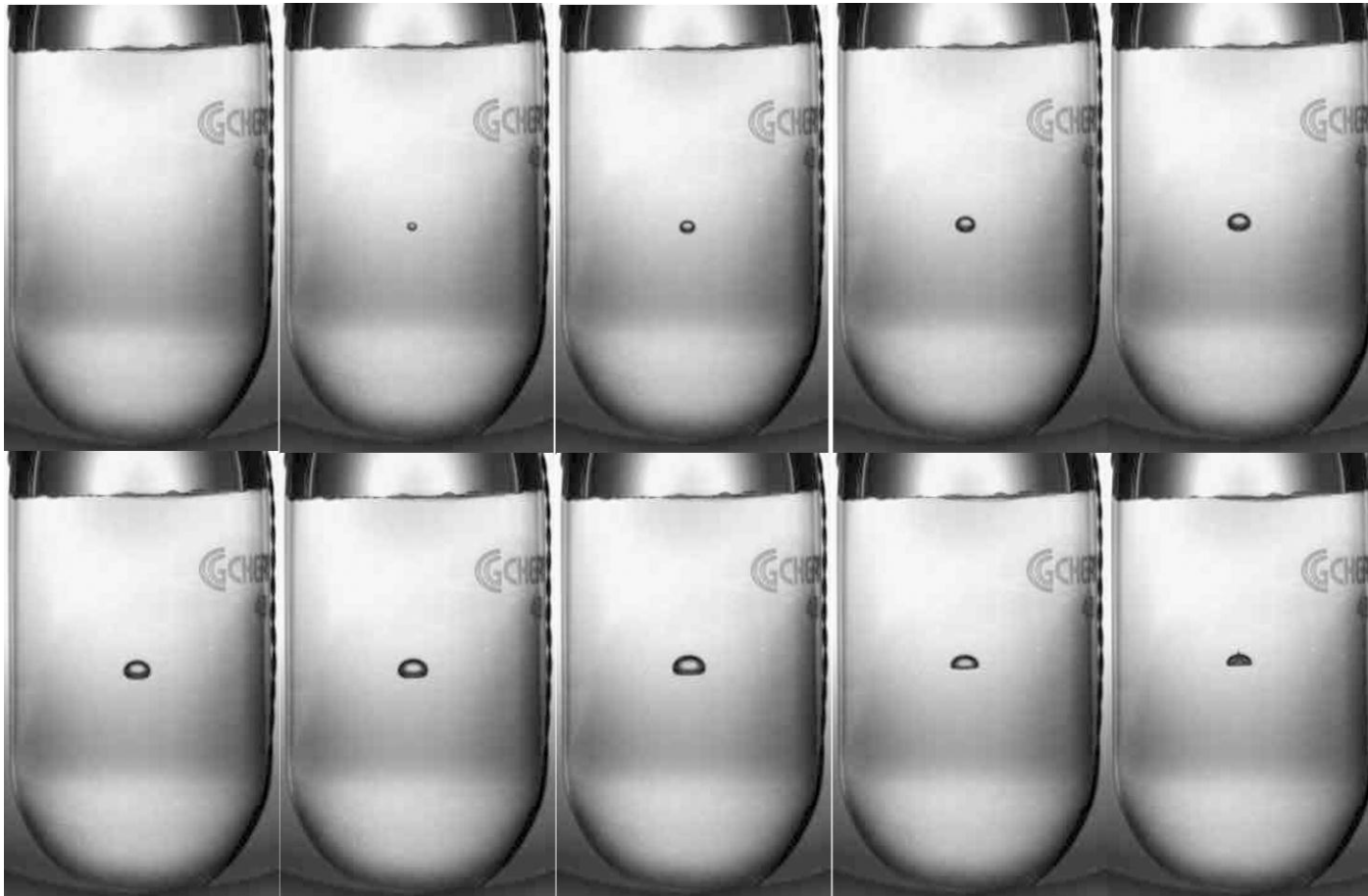

$^{19}\text{F}(\gamma, \alpha)^{15}\text{N}$ in R134a

$\Delta t = 10 \text{ ms}$

ACOUSTIC SIGNAL: PARTICLE ID

Acoustic Signatures, time domain

Suppress neutron events by x500 from acoustic signal – FNAL dark matter bubble chambers

Neutron

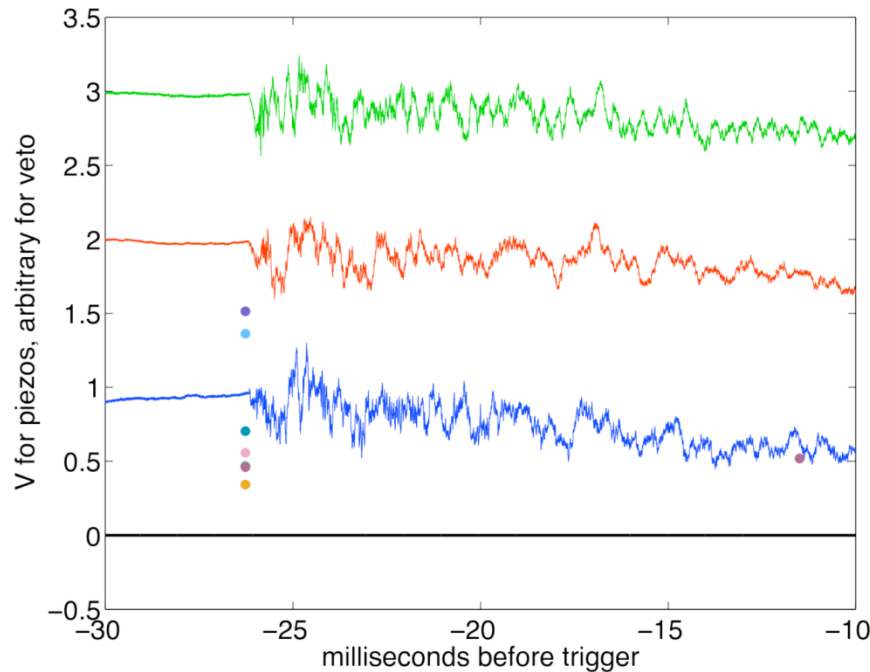

Alpha

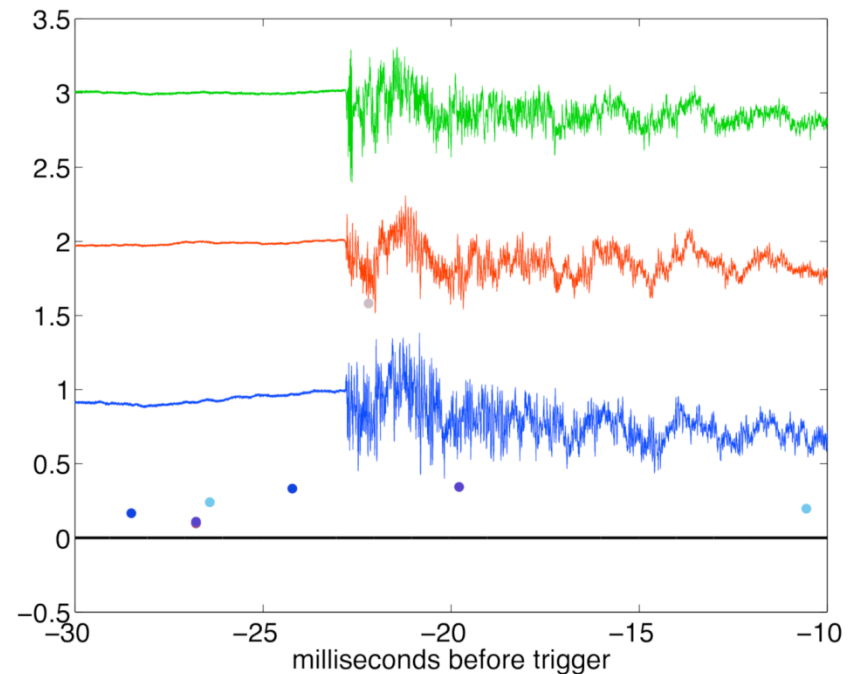

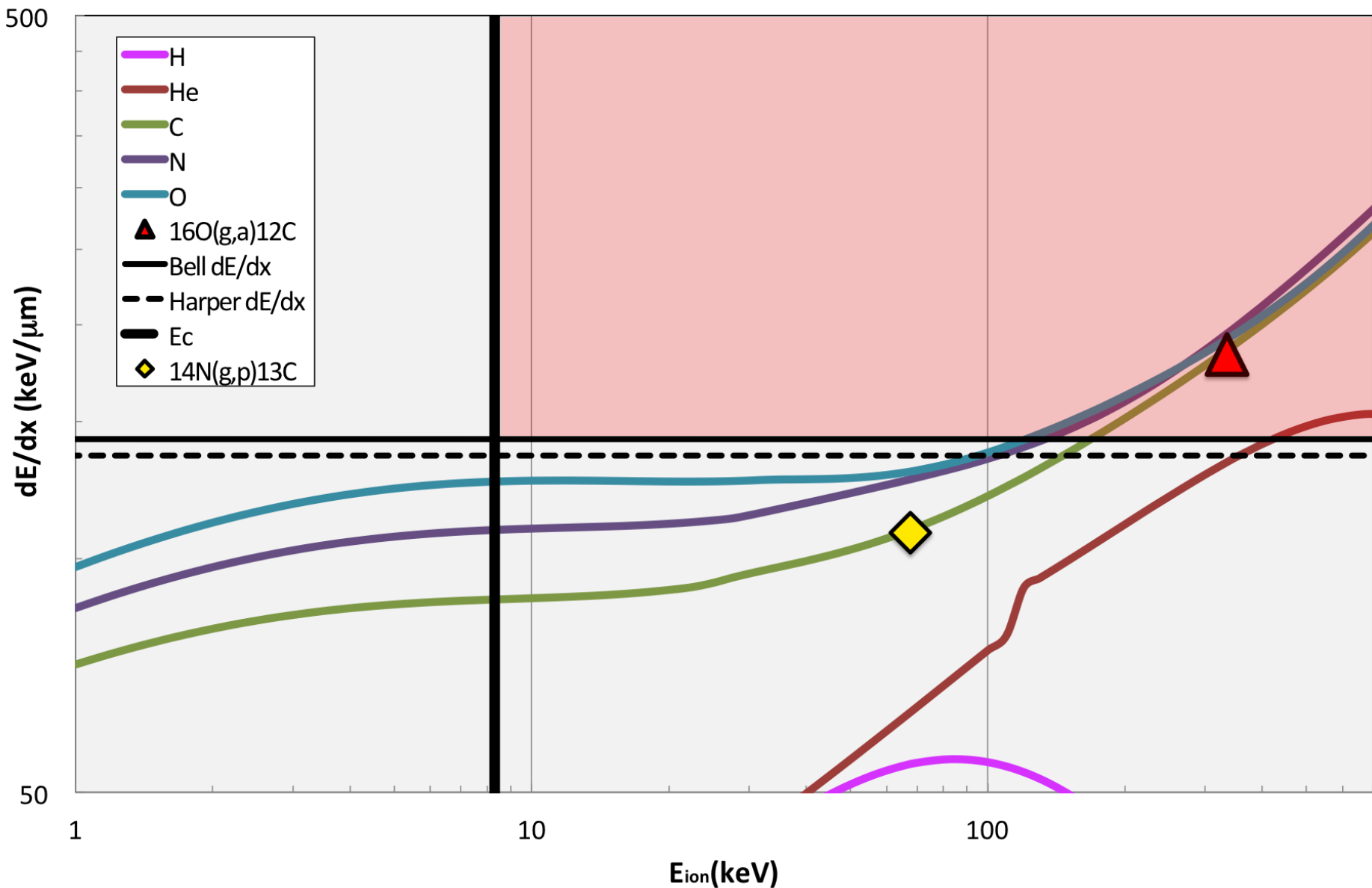

EFFICIENCY CURVE

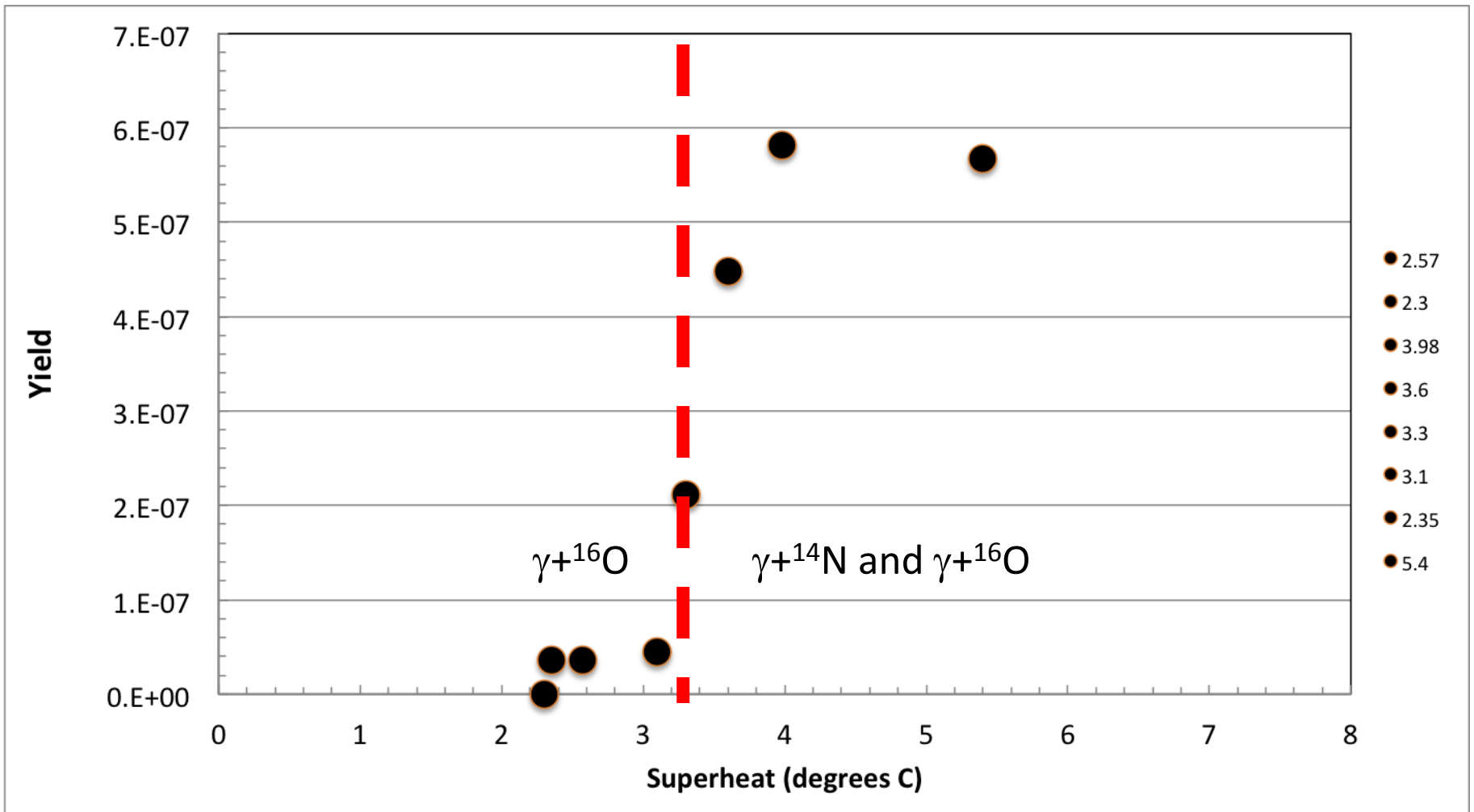

N_2O efficiency curve, HIGS April 2013. $E_\gamma = 9.7$ MeV

BUBBLE CHAMBER AT HIGS

- I. High Intensity Gamma Source (HIGS) at Duke University
- II. γ -rays generated by Compton backscattering of free-electron-laser (FEL) light from high-energy electron beam bunches

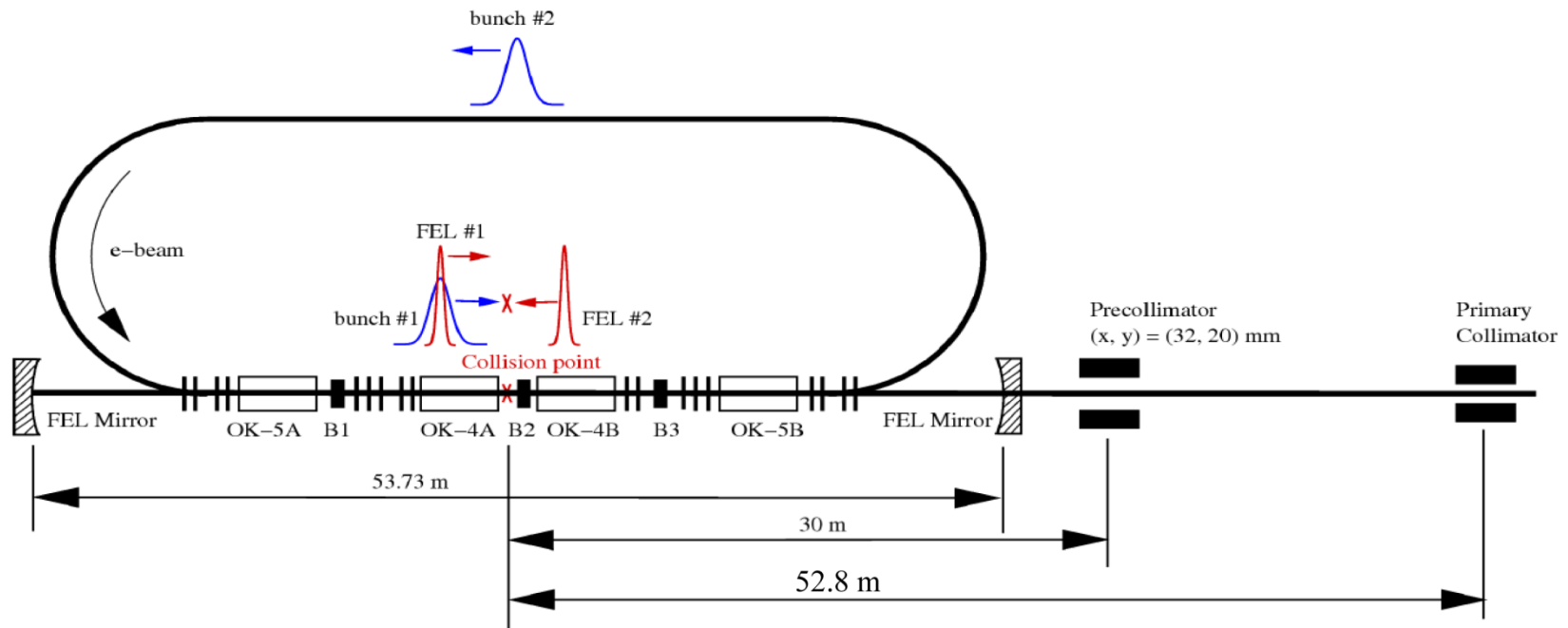

MEASURING $^{19}\text{F}(\gamma, \alpha)^{15}\text{N}$ AT HIGS

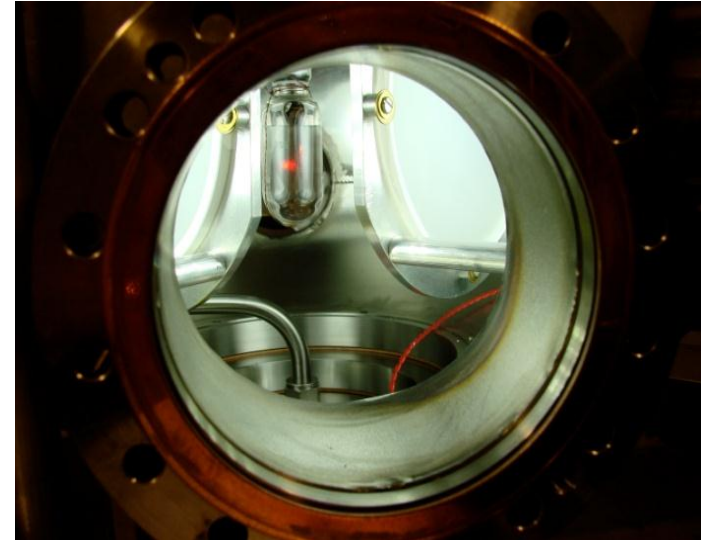
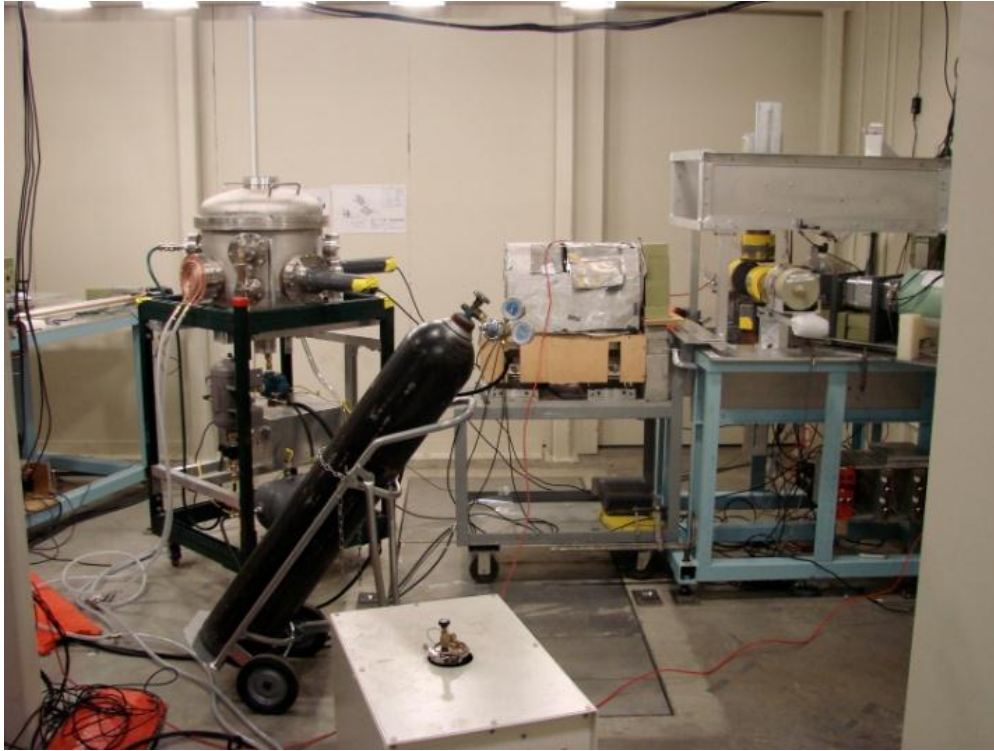

C_4F_{10} Bubble Chamber
T = 310 K
P = 160 kPa – 900 kPa

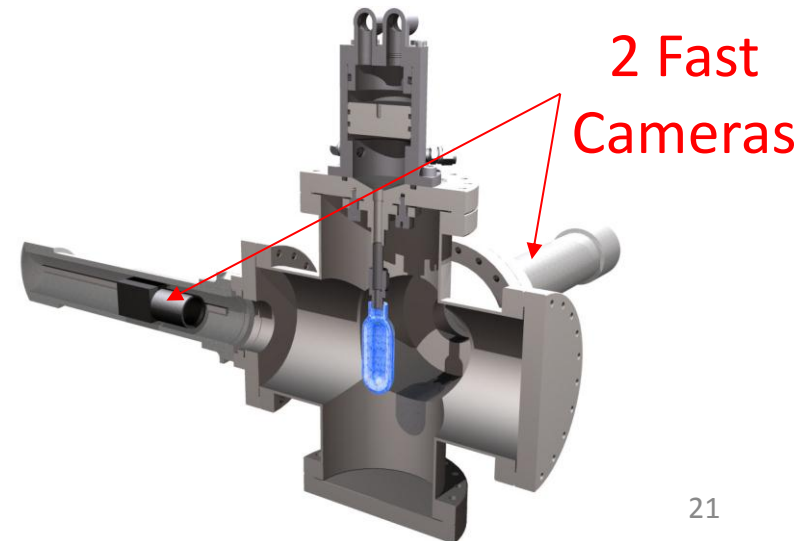



Contents lists available at SciVerse ScienceDirect

Physics Letters B

www.elsevier.com/locate/physletb



First determination of an astrophysical cross section with a bubble chamber: The $^{15}\text{N}(\alpha, \gamma)^{19}\text{F}$ reaction

C. Ugalde ^{a,*}, B. DiGiovine ^b, D. Henderson ^b, R.J. Holt ^b, K.E. Rehm ^b, A. Sonnenschein ^c, A. Robinson ^d,
R. Raut ^{e,f,1}, G. Rusev ^{e,f,2}, A.P. Tonchev ^{e,f,3}

^a Department of Astronomy and Astrophysics, University of Chicago, Chicago, IL 60637, USA

^b Physics Division, Argonne National Laboratory, Argonne, IL 60439, USA

^c Fermi National Accelerator Laboratory, Batavia, IL 60510, USA

^d Department of Physics, University of Chicago, Chicago, IL 60637, USA

^e Department of Physics, Duke University, Durham, NC 27708, USA

^f Triangle Universities Nuclear Laboratory, Durham, NC 27708, USA

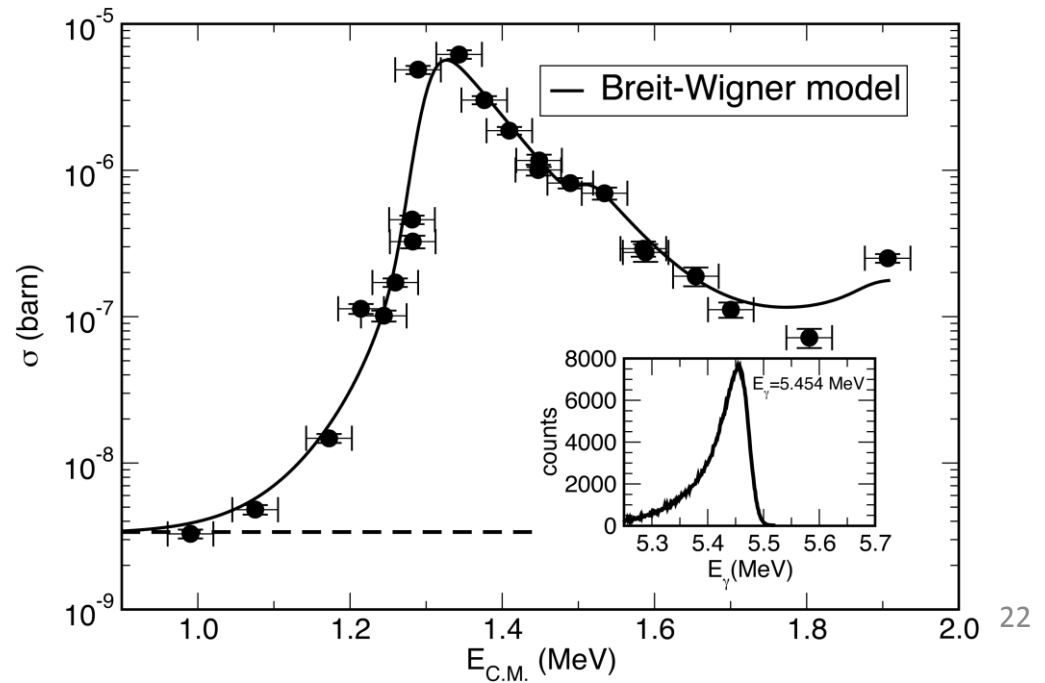
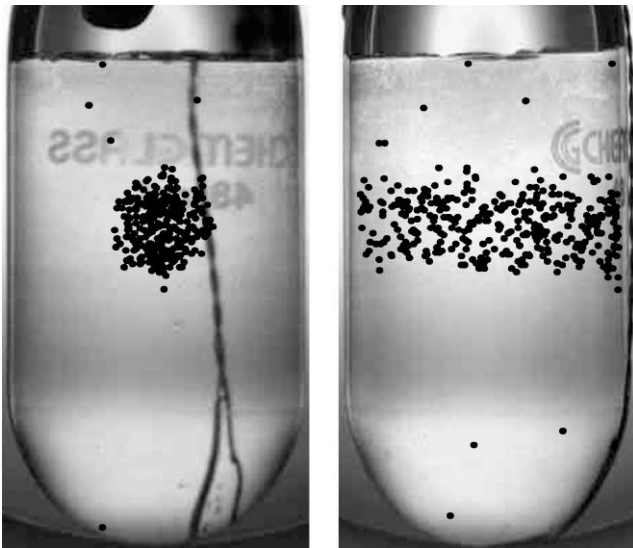

BREMSSTRAHLUNG BACKGROUND AT HIGS

Vacuum: 2×10^{-10} Torr

Residual Gas: $Z = 10$

Electron Beam Energy: 400 MeV

Electron Beam Current: 41 mA

Interaction Length: 35 m

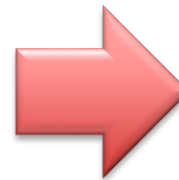

Strong Bremsstrahlung
Background

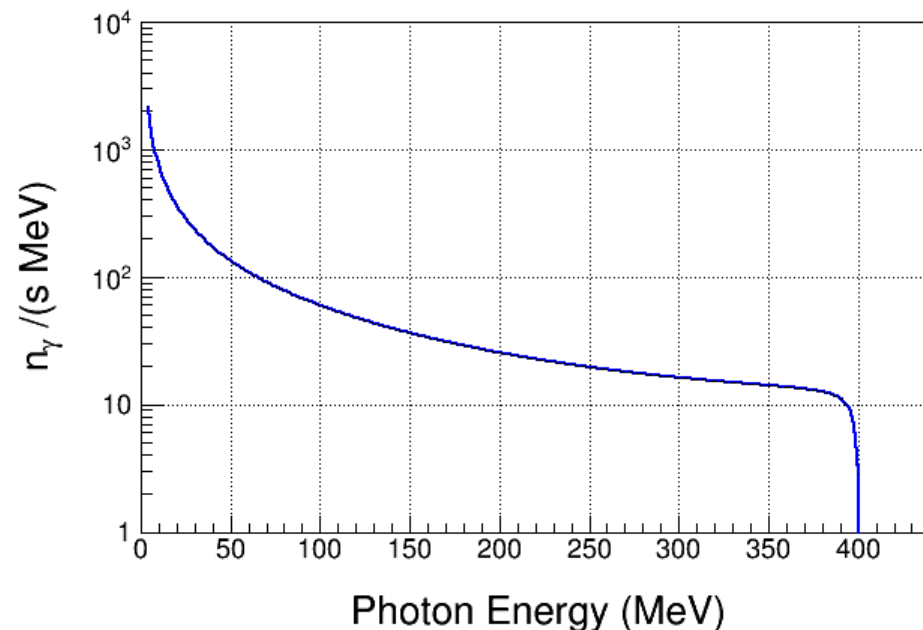

RECENT WORK

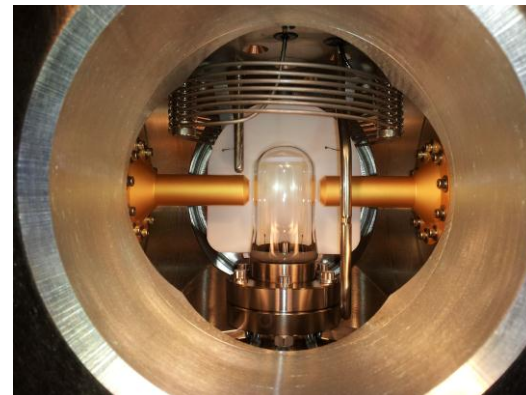
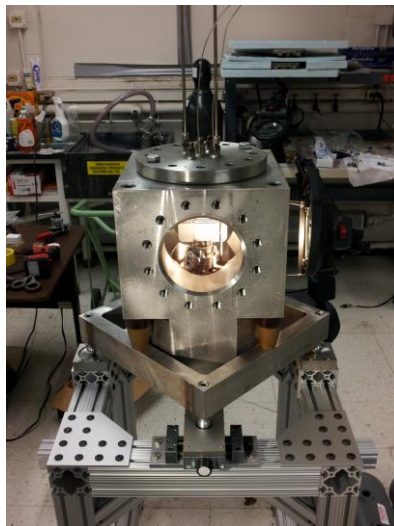
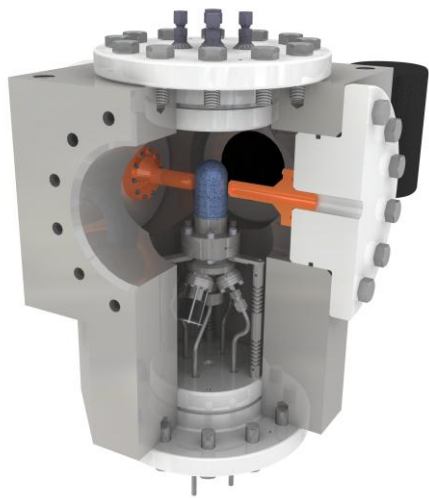

N₂O Bubble Chamber
First $\gamma+O \rightarrow \alpha+C$ bubble
April 2013

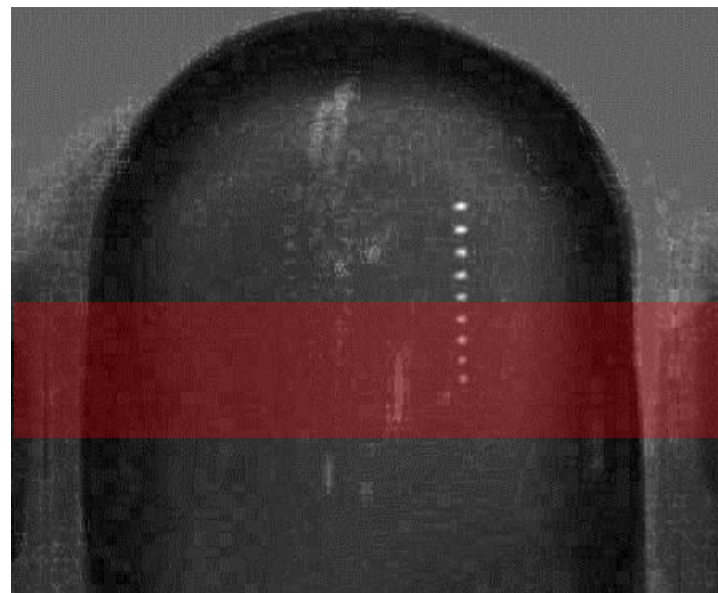
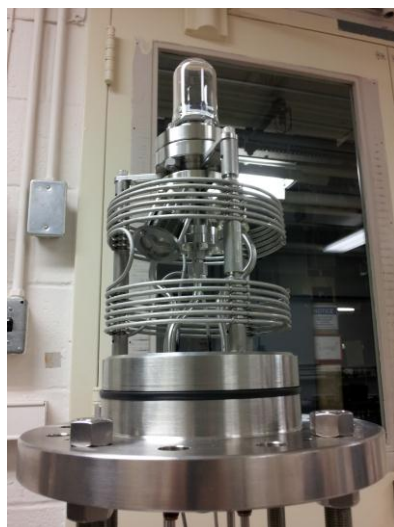
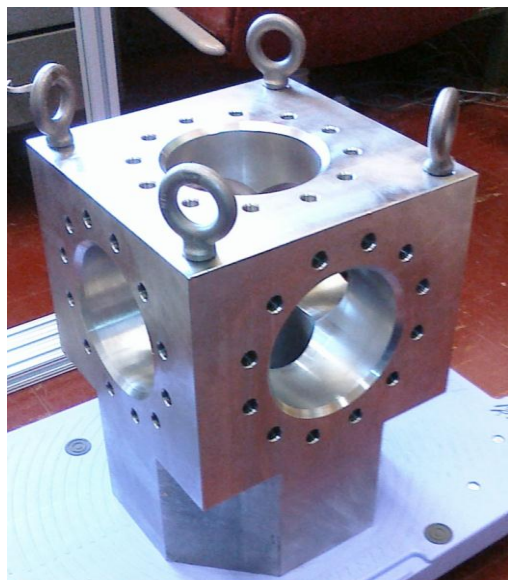

SUPERHEATED TARGETS

I. List of superheated liquids to be used in the experiment:

N₂O Targets	¹⁶O	¹⁷O	¹⁸O
Natural Target	99.757%	0.038%	0.205%
¹⁶ O Target		Depleted > 5,000	Depleted > 5,000
¹⁷ O Target		Enriched > 80%	<1.0%
¹⁸ O Target		<1.0%	Enriched > 80%

II. Readout:

- I. Optical Camera
- II. Acoustic Signal to discriminate between (γ, α) and (γ, n) events

EXPERIMENTAL SETUP

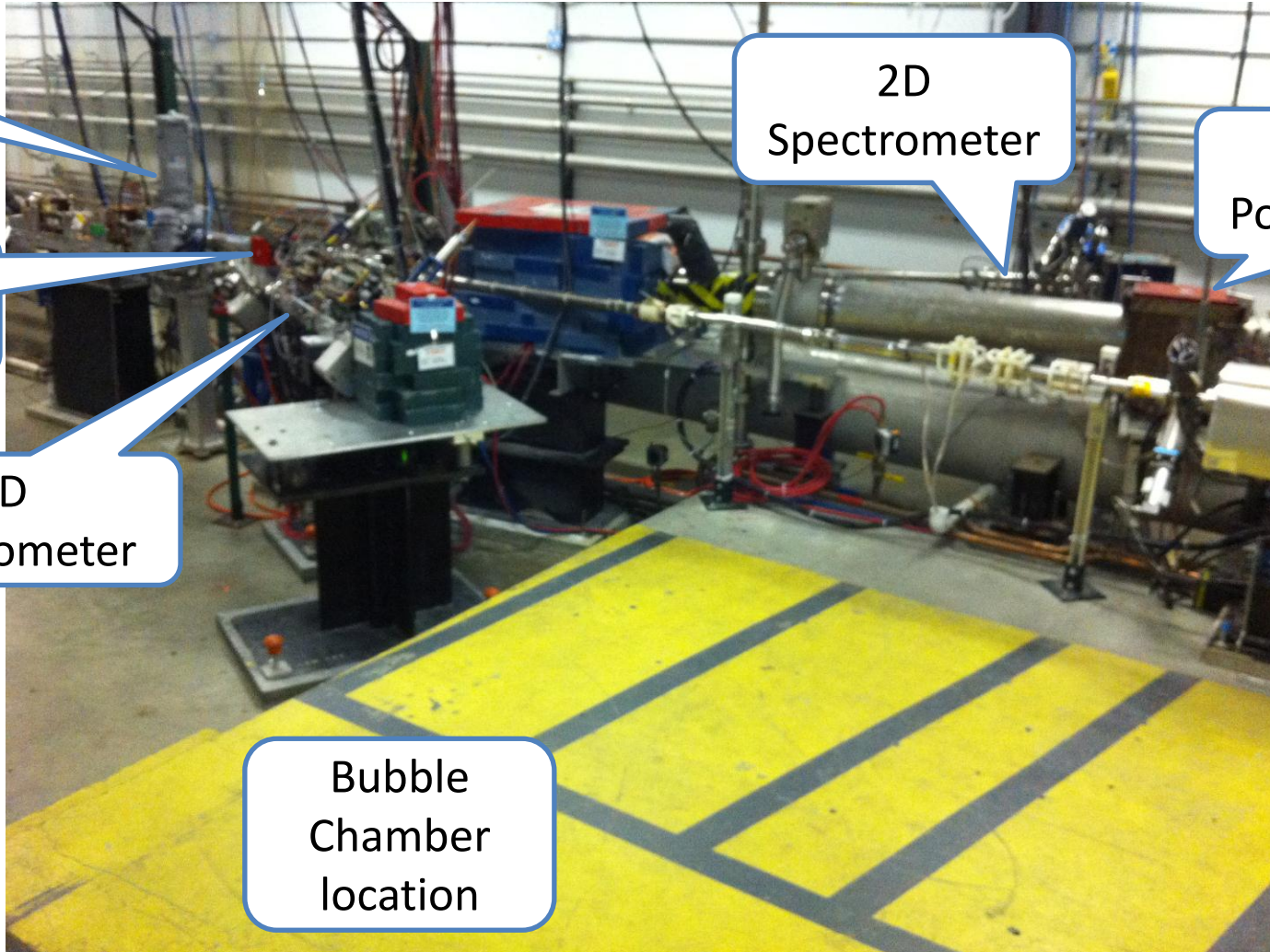

BCM

5 MeV
Dipole

5D
Spectrometer

2D
Spectrometer

Mott
Polarimeter

Bubble
Chamber
location

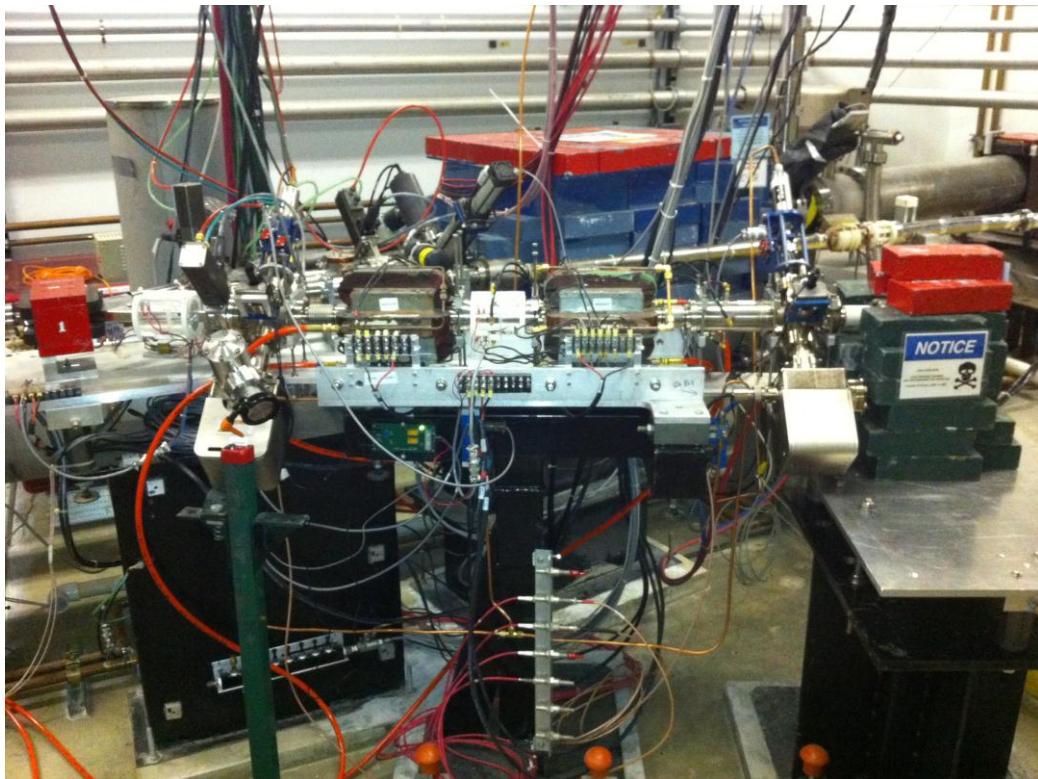

5D
Spectrometer

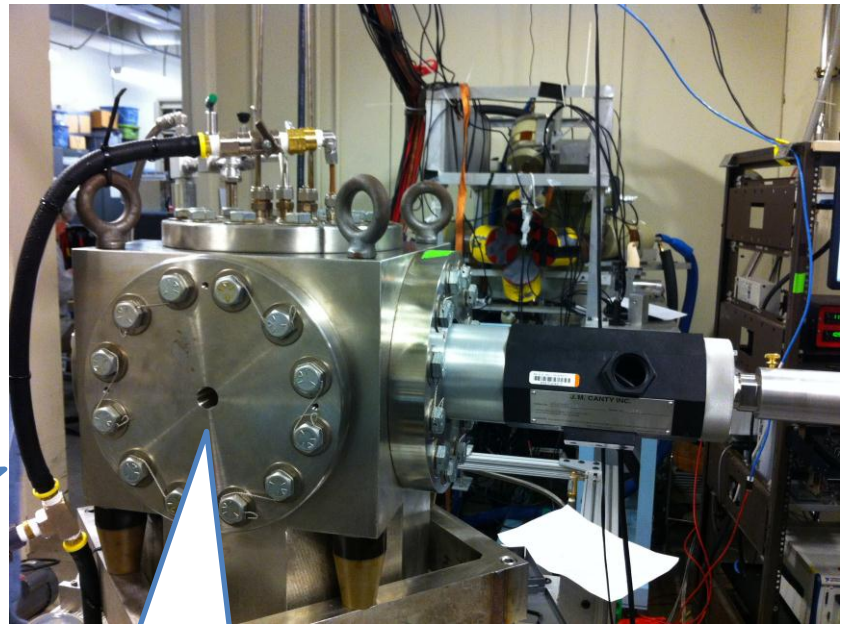

Bubble
Chamber at
HIGS

Photon Beam
Entrance

BEAMLINE

Replace Dipole Magnet

New Fast Valve to protect from vacuum failure in front of ¼ Cryo-unit

2 Superharps to measure beam profile and absolute beam position

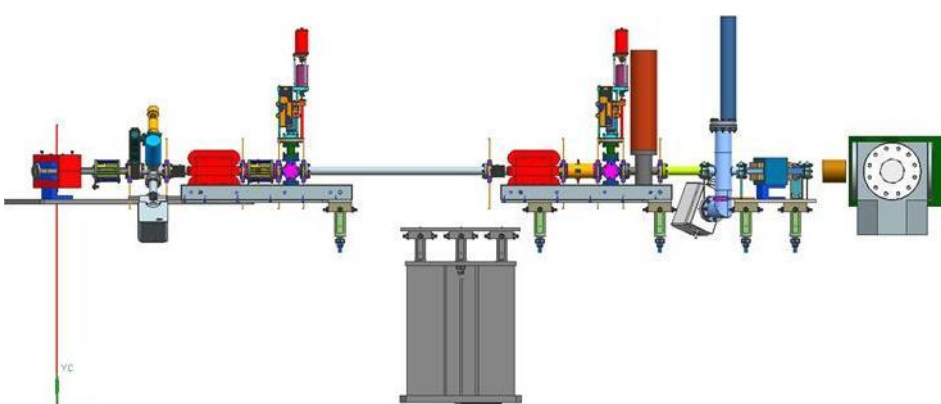
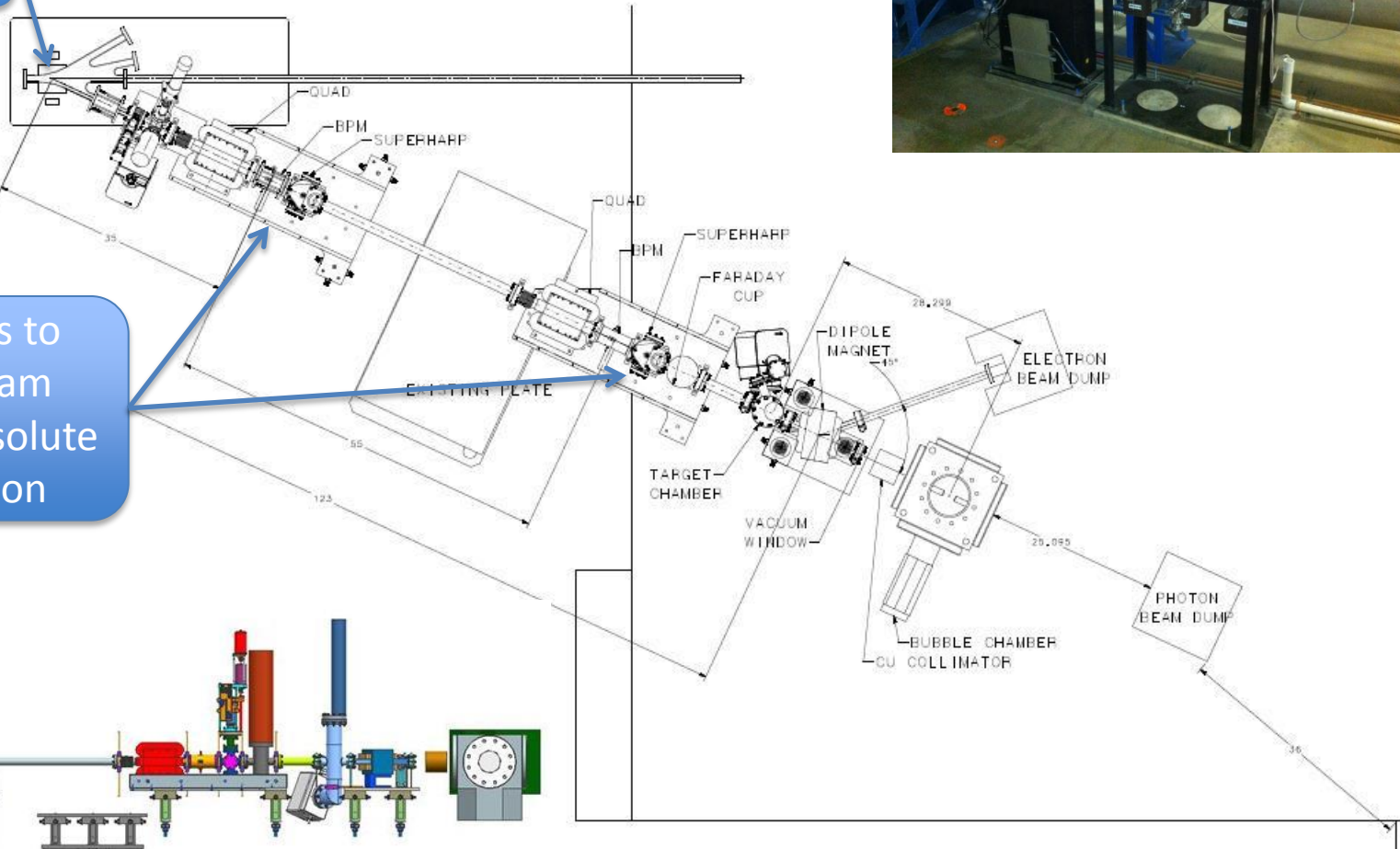

SCHEMATICS

- Power deposited in radiator (100 μ A and 8.5 MeV) :
 - 0.02 mm: Energy loss = 21 keV, P = 2.1 W
 - 0.10 mm: Energy loss = 112 keV, P = 11 W
- Pure Copper and Aluminum (high neutron threshold):
 - $^{63}\text{C}(\gamma, n)$ threshold = 10.86 MeV
 - $^{27}\text{Al}(\gamma, n)$ threshold = 13.06 MeV

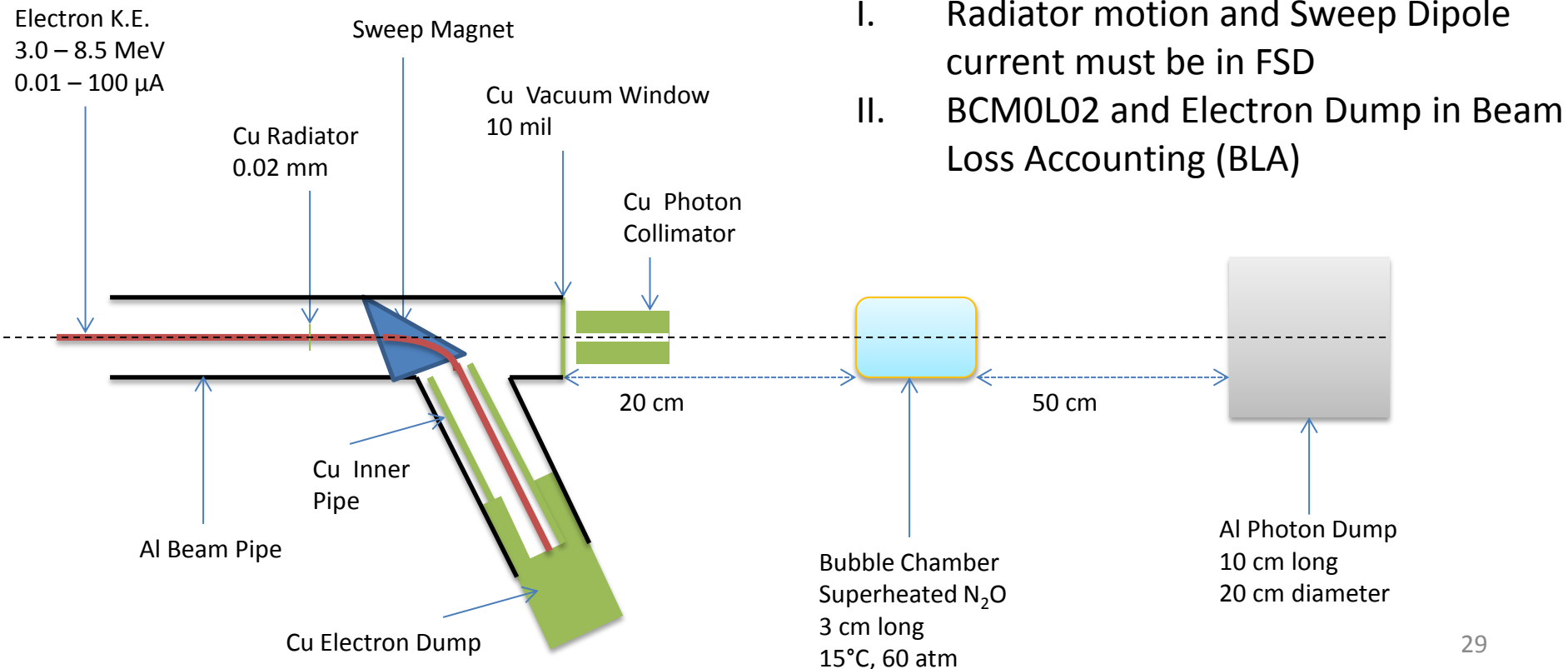

BEAM REQUIREMENTS

I. Beam Properties at Radiator:

Beam Kinetic Energy, (MeV)	7.9 – 8.5
Beam Current (μA)	0.01 – 100
Absolute Beam Energy	<0.1%
Relative Beam Energy	<0.02%
Energy Resolution (Spread), σ_T/T	0.06%
Beam Size, $\sigma_{x,y}$ (mm)	1 – 2

II. PEPPo achieved $p=8.25$ MeV/c or K.E.=7.75 MeV. Maximum stable $\frac{1}{4}$ - cryounit cavity gradients achieved: 8.4 MV/m and 6.1 MV/m (7.25 MV/m average). Vacuum in the beam line indicates that field emission and desorbed gas are the most problematic, but improve with processing.

III. Helium process the $\frac{1}{4}$ -cryounit

ABSOLUTE BEAM ENERGY

□ BPM

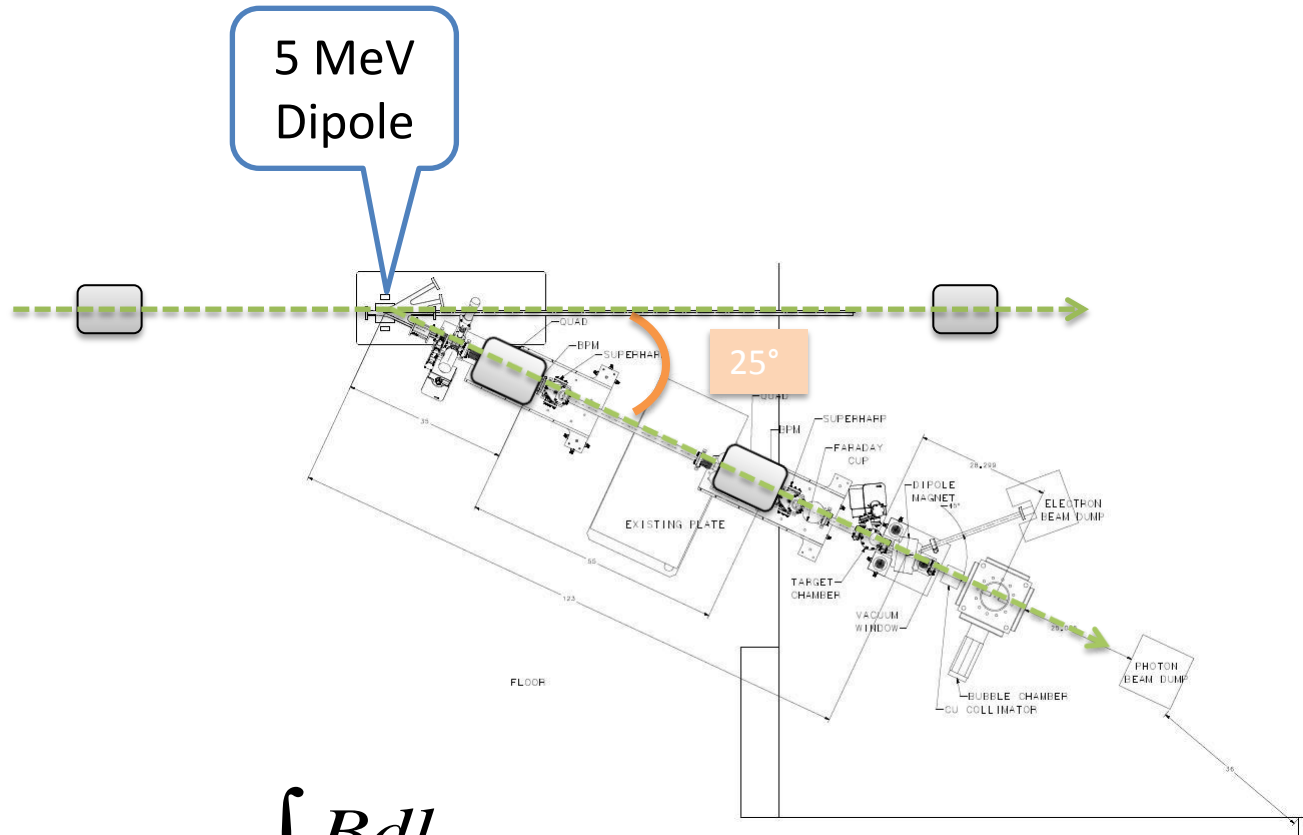

Electron Beam
Momentum

$$p = \frac{\int Bdl}{\theta}$$

Parameter	Term	Now	Goal
Dipole – linearity	$\delta B/B$	0.25%	0.02%
Dipole – spatial	$\delta BL/BL$	0.10%	0.02%
Dipole – reproduce	$\delta B/B$	0.10%	0.02%
Dipole – power supply	$\delta I/I$	0.20%	0.02%
Position – surveys	$\delta \theta/\theta$	0.01%	0.01%
Position – BPM calibration	$\delta \theta/\theta$	0.05%	0.05%
Stray magnetic field	$\delta \theta/\theta$	0.05%	0.05%
TOTAL	$\delta P/P$	0.36%	<0.10%

Goal:

- I. Jay Benesch designed and now fabricating higher quality dipole (more uniformity, higher field)
- II. New Hall Probe: 0.01% accuracy, resolution to 2 ppm, and a temperature stability of 10 ppm/°C
- III. Relative beam energy error: <0.02%

Non-resonant charged particle reactions (The Gamow peak)

Let's write the cross section as $\sigma(E) = \frac{1}{E} \exp(-2\pi\eta) S(E)$

and substitute in $\langle \sigma v \rangle = \left(\frac{8}{\pi\mu}\right)^{1/2} \frac{1}{(kT)^{3/2}} \int_0^\infty \sigma(E) E \exp\left(-\frac{E}{kT}\right) dE$

If no resonances are present $S(E) = S(E_0) = \text{constant}$, so

$$\langle \sigma v \rangle = \left(\frac{8}{\pi\mu}\right)^{1/2} \frac{1}{(kT)^{3/2}} S(E_0) \int_0^\infty \exp\left(-\frac{E}{kT} - \frac{b}{E^{1/2}}\right) dE \quad b = \left(\frac{2\mu}{\hbar^2}\right)^{1/2} \pi Z_1 Z_2 e^2$$

Gamow peak

- * The rate has a peak shape product of two negative exponentials: Maxwell-Boltzmann distribution at low energy and tunneling through the Coulomb barrier for higher E.
- * It represents the region in energy where reactions are more likely to occur.
- * The concept can be extended to a general $S(E)$

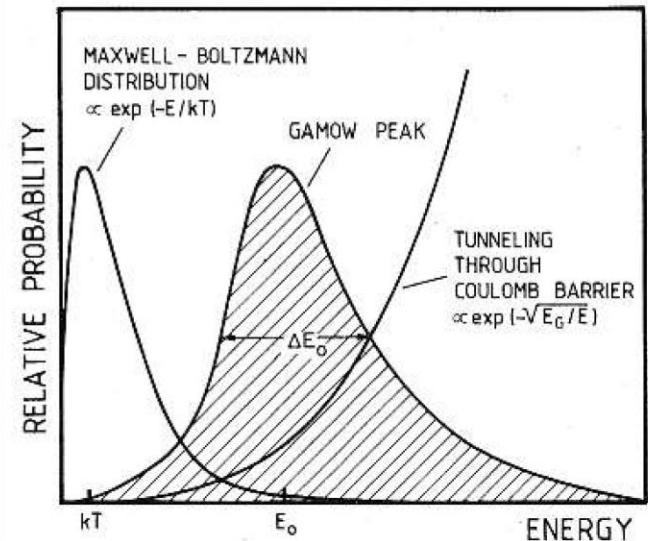

BREMSSTRAHLUNG BEAM

- Use both GEANT4 and FLUKA to calculate Bremsstrahlung spectra
- Monte Carlo simulation of bremsstrahlung at radiotherapy energies is well studied, accuracy: 5%

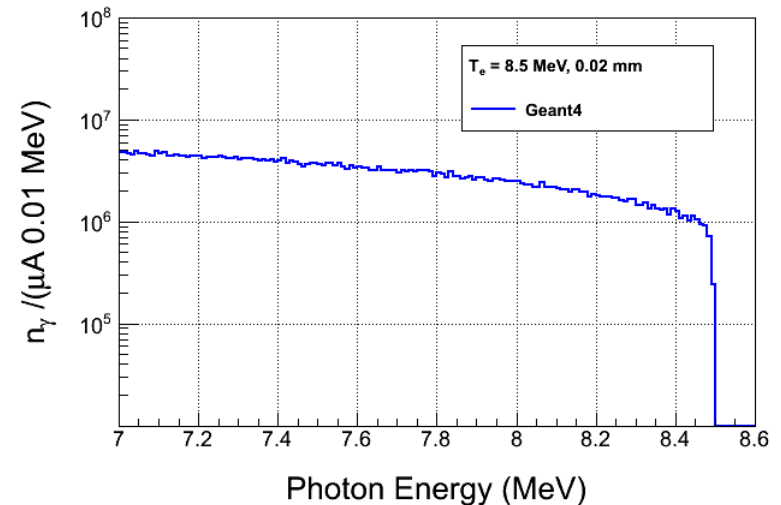

Bremsstrahlung
Peaks

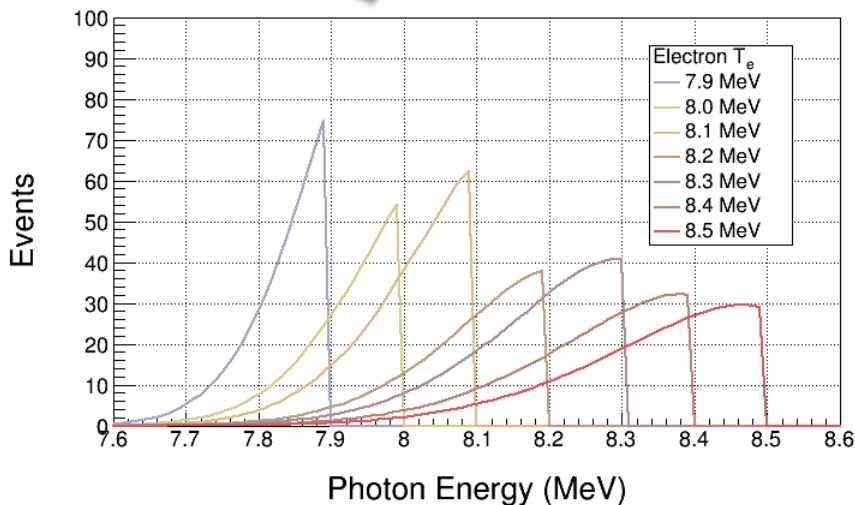

- $^{16}\text{O}(\gamma, \alpha)^{12}\text{C}$ is ideal case for Bremsstrahlung beam and Penfold – Leiss Unfolding :
- Very steep; only photons near endpoint contribute to yield
 - No-structure (resonances)

GEANT4 SIMULATION

- Both GEANT4 and FLUKA use models that calculate wrong photo–nuclear cross sections. Both do not allow for user’s cross sections.
 - I. Use GEANT4 and FLUKA to produce the photon spectrum impinging on the super heated liquid.
 - II. Fold the above photon spectrum with our cross sections in stand-alone codes.
- Use GEANT4 to design Radiator/Collimator/Dump
- Geometry in GEANT4:

Penfold-Leiss Cross Section Unfolding

- Measure Yields at: $E = E_1, E_2, \dots, E_n$ where,

$$E_i - E_{i-1} = \Delta, i = 2, n$$

$$Y(E_i) = \int_{th}^{E_i} n_\gamma(E_i, k) \sigma(k) dk \approx \sum_{j=1}^i N_\gamma(E_i, \Delta, E_j) \sigma(E_j)$$

- The solution can be written in two forms:

$$\sigma_i = \frac{1}{N_{ii}} \left[y_i - \sum_{j=1}^{i-1} (N_{ij} \sigma_j) \right]$$

- Or, Matrix form:

$$\begin{bmatrix} y_1 \\ y_2 \\ \vdots \\ y_n \end{bmatrix} = \begin{bmatrix} N_{\gamma,11} & 0 & \dots & 0 \\ N_{\gamma,21} & N_{\gamma,22} & \dots & 0 \\ \vdots & \ddots & \ddots & 0 \\ N_{\gamma,n1} & N_{\gamma,n2} & \dots & N_{\gamma,nn} \end{bmatrix} \begin{bmatrix} \sigma_1 \\ \sigma_2 \\ \vdots \\ \sigma_n \end{bmatrix}$$

$$[Y] = [N] \bullet [\sigma]$$

$$[\sigma] = [N]^{-1} \bullet [Y]$$

Statistical Error Propagation

- Note: $\frac{dy_i}{y_i} = \frac{1}{\sqrt{y_i}}$ $\frac{dN_{ij}}{N_{ij}} = \frac{1}{\sqrt{N_{ij}}} \approx 0$

$$dy_i = \sqrt{y_i} \qquad dy_i = \sqrt{y_i + 2y_i^{bg}}$$

In case of
background
Subtraction

- With:

$$[B] = [N]^{-1}$$

$$[\sigma] = [B] \bullet [Y]$$

- Then:

$$[d\sigma^2] = [B] \bullet [dY^2] \bullet [B]^T$$

- Where:

$$[dY^2] = \begin{bmatrix} y_1 & 0 & \cdots & 0 \\ 0 & y_2 & \cdots & 0 \\ \vdots & \ddots & \ddots & \vdots \\ 0 & 0 & \cdots & y_n \end{bmatrix}$$

$$\begin{aligned} \text{var}(y_i, y_i) &= y_i \\ \text{cov}(y_i, y_j) &= 0 \end{aligned}$$

$$[d\sigma^2] = \begin{bmatrix} d\sigma_1^2 & \text{cov}(\sigma_1, \sigma_2) & \cdots & \text{cov}(\sigma_1, \sigma_n) \\ \text{cov}(\sigma_2, \sigma_1) & d\sigma_2^2 & \cdots & \text{cov}(\sigma_2, \sigma_n) \\ \vdots & \ddots & \ddots & \vdots \\ \text{cov}(\sigma_n, \sigma_1) & \text{cov}(\sigma_n, \sigma_2) & \cdots & d\sigma_n^2 \end{bmatrix}$$

Although,

$$\begin{aligned} \text{cov}(y_i, y_j) &= 0, \\ \text{cov}(\sigma_i, \sigma_j) &\neq 0 \end{aligned}$$

$$(d\sigma_i)^2 = \frac{1}{N_{ii}^2} \left[dy_i^2 + \sum_{j=1}^{i-1} (N_{ij} d\sigma_j)^2 + \sum_{k=1}^{i-1} \sum_{l=1}^{i-1} N_{ik} \text{cov}(\sigma_k, \sigma_l) N_{il} \right]$$

For mono-
chromatic
beam

$$\left(\frac{d\sigma_i}{\sigma_i} \right)^2 = \left(\frac{dy_i}{y_i} \right)^2 = \frac{1}{y_i}$$

RESULTS

- I. Radiator Thickness = 0.02 mm
- II. Bubble Chamber Thickness = 3.0 cm. Number of ^{16}O nuclei = $3.474e22 / \text{cm}^2$
- III. Background subtraction of $^{18}\text{O}(\gamma, \alpha)^{14}\text{C}$. $^{17}\text{O}(\gamma, n)^{16}\text{O}$: Still to do

$$[N] = \begin{bmatrix} 3.267e14 & 0 & 0 & 0 & 0 & 0 & 0 \\ 9.782e13 & 6.439e13 & 0 & 0 & 0 & 0 & 0 \\ 5.013e13 & 3.858e13 & 2.539e13 & 0 & 0 & 0 & 0 \\ 1.494e13 & 1.236e13 & 9.514e12 & 6.258e12 & 0 & 0 & 0 \\ 8.540e12 & 7.369e12 & 6.097e12 & 4.692e12 & 3.086e12 & 0 & 0 \\ 3.801e12 & 3.370e12 & 2.908e12 & 2.406e12 & 1.852e12 & 1.217e12 & 0 \\ 2.075e12 & 1.875e12 & 1.663e12 & 1.435e12 & 1.187e12 & 9.137e11 & 6.004e11 \end{bmatrix}$$

Electron Beam K. E.	Beam Current (μA)	Time (hour)	y_i	dy_i (no bg)	dy_i/y_i (no bg, %)	dy_i (with bg)	dy_i/y_i (with bg, %)
7.9	100	100	545	23	4.2	134	24.6
8.0	100	20	581	24	4.1	77	13.3
8.1	80	10	852	29	3.4	60	7.0
8.2	20	10	634	25	3.9	40	6.3
8.3	10	10	812	28	3.4	39	4.8
8.4	4	10	746	27	3.6	36	4.8
8.5	2	10	763	28	3.7	32	4.2

Systematic Error Propagation

- For absolute beam energy uncertainty of δE ($= 0.1\%$) and zero relative beam energy uncertainty:

$$\frac{dy_i}{y_i} = \frac{y_i(E_i + \delta E) - y_i(E_i)}{y_i(E_i)}$$

$$\frac{dN_{ij}}{N_{ij}} = \frac{N_{ij}(E_i + \delta E) - N_{ij}(E_i)}{N_{ij}(E_i)}$$

$$E_0 = 7.8 + \delta E$$

$$E_i = E_0 + i\Delta$$

E_i (MeV)	dy_i/y_i (%)	$d\sigma_i/\sigma_i$ (%)
7.9	12.5	12.6
8.0	10.8	10.5
8.1	9.3	9.1
8.2	8.0	7.1
8.3	7.0	6.3
8.4	6.3	5.8
8.5	5.6	5.2

This is the cross section dependence on energy

- Accounted for dN_{ij} due to energy error when calculating dy_i

$$\approx \frac{\delta E}{i\Delta}$$

$$\left[\frac{dN_{ij}}{N_{ij}} \right] = \begin{bmatrix} 0.100 & 0 & 0 & 0 & 0 & 0 & 0 \\ 0.058 & 0.050 & 0 & 0 & 0 & 0 & 0 \\ 0.041 & 0.039 & 0.033 & 0 & 0 & 0 & 0 \\ 0.031 & 0.031 & 0.029 & 0.025 & 0 & 0 & 0 \\ 0.025 & 0.025 & 0.025 & 0.023 & 0.020 & 0 & 0 \\ 0.021 & 0.021 & 0.021 & 0.021 & 0.020 & 0.017 & 0 \\ 0.018 & 0.018 & 0.018 & 0.018 & 0.018 & 0.017 & 0.022 \end{bmatrix}$$

- With:

$$[B] = [N]^{-1}$$

$$[\sigma] = [B] \bullet [Y]$$

- Then:

$$[d\sigma^2] = [B] \bullet \left([dY^2] + [dN^2] \bullet [\sigma^2] \right) \bullet [B]^T$$

- Where:

Note: Correlation Coefficient = 1

$$[dY^2] = \begin{bmatrix} (dy_1)^2 & dy_1 dy_2 & \cdots & dy_1 dy_n \\ dy_2 dy_1 & (dy_2)^2 & \cdots & dy_n dy_n \\ \vdots & \ddots & \ddots & \vdots \\ dy_n dy_1 & dy_n dy_2 & \cdots & (dy_n)^2 \end{bmatrix}$$

$$\begin{aligned} \text{var}(y_i, y_i) &= (dy_i)^2 \\ \text{cov}(y_i, y_j) &= \rho_{ij} dy_i dy_j \end{aligned}$$

No point-to-point systematic

$$[d\sigma^2] = \begin{bmatrix} d\sigma_1^2 & \text{cov}(\sigma_1, \sigma_2) & \cdots & \text{cov}(\sigma_1, \sigma_n) \\ \text{cov}(\sigma_2, \sigma_1) & d\sigma_2^2 & \cdots & \text{cov}(\sigma_2, \sigma_n) \\ \vdots & \ddots & \ddots & \vdots \\ \text{cov}(\sigma_n, \sigma_1) & \text{cov}(\sigma_n, \sigma_2) & \cdots & d\sigma_n^2 \end{bmatrix}$$

$$[dN^2] = \begin{bmatrix} (dN_{11})^2 & 0 & \cdots & 0 \\ (dN_{21})^2 & (dN_{22})^2 & \cdots & 0 \\ \vdots & \ddots & \ddots & \vdots \\ (dN_{n1})^2 & (dN_{n2})^2 & \cdots & (dN_{nn})^2 \end{bmatrix}$$

$$[\sigma^2] = \begin{bmatrix} \sigma_1^2 & 0 & \cdots & 0 \\ 0 & \sigma_2^2 & \cdots & 0 \\ \vdots & \ddots & \ddots & \vdots \\ 0 & 0 & \cdots & \sigma_n^2 \end{bmatrix}$$

Systematic Error Propagation

$$\begin{aligned}
 (d\sigma_i)^2 \cong & \frac{1}{N_{ii}^2} \left[dy_i^2 - 2dy_i \sum_{j=1}^{i-1} N_{ij} d\sigma_j \right. \\
 & + \sum_{j=1}^{i-1} (N_{ij} d\sigma_j)^2 + \sum_{k=1}^{i-1} \sum_{l=1}^{i-1} N_{ik} \text{cov}(\sigma_k, \sigma_l) N_{il} \\
 & \left. + \sum_{j=1}^{i-1} (dN_{ij} \sigma_j)^2 + (dN_{ii} \sigma_i)^2 \right]
 \end{aligned}$$

No point-to-point systematic

$\text{cov}(y_i, y_j) \neq 0,$
 $\text{cov}(\sigma_i, \sigma_j) \neq 0$

Other Relative Systematic Errors

Beam Current, $\delta I/I$	3%
Photon Flux, $\delta\phi/\phi$	5%
Radiator Thickness, $\delta R/R$	3%
Bubble Chamber Thickness, $\delta T/T$	3%
Bubble Chamber Efficiency, ε	5%

Simulation

- Then:

$$(dy_i)^2 = (dy_i(\delta E))^2 + \left[\left(\frac{\delta I}{I} \right)^2 + \left(\frac{\delta R}{R} \right)^2 + \left(\frac{\delta T}{T} \right)^2 + \varepsilon^2 \right] y_i^2$$

$$(dN_{ij})^2 = \left(\frac{\delta\phi}{\phi} \right)^2 N_{ij}^2$$

Electron Beam K. E.	Cross Section (nb)	Stat Error (no bg, %)	Stat Error (with bg, %)
7.9	0.046	4.4	24.5
8.0	0.185	6.0	20.7
8.1	0.58	6.3	14.7
8.2	1.53	8.2	13.8
8.3	3.49	9.1	13.3
8.4	7.2	10.6	13.8
8.5	13.6	12.2	14.8

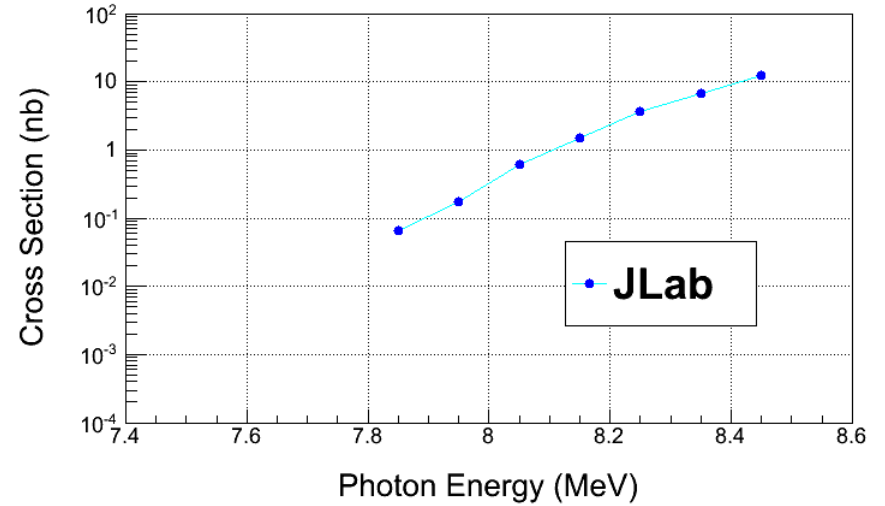

Electron Beam K. E.	Cross Section (nb)	Sys Error (Energy, %)	Sys Error (Total, %)
7.9	0.046	12.5	15.3
8.0	0.185	10.2	13.5
8.1	0.58	8.3	12.2
8.2	1.53	7.0	11.4
8.3	3.49	6.0	10.7
8.4	7.2	5.3	10.5
8.5	13.6	4.7	10.1

Note: Relative systematic errors do not get amplified in PL Unfolding

$^{12}\text{C}(\alpha, \gamma)^{16}\text{O}$ S-Factor

- Statistical Error: dominated by background subtraction from $^{18}\text{O}(\gamma, \alpha)^{14}\text{C}$ (depletion = 5,000)

Electron Beam K. E.	Gamma Energy (MeV)	E_{CM} (MeV)	Cross Section (nb)	S_{E1} Factor (keV b)	Stat Error (%)	Sys Error (Total, %)
7.9	7.85	0.69	0.046	62.2	24.5	15.3
8.0	7.95	0.79	0.185	48.7	20.7	13.5
8.1	8.05	0.89	0.58	41.8	14.7	12.2
8.2	8.15	0.99	1.53	35.5	13.8	11.4
8.3	8.25	1.09	3.49	32.0	13.3	10.7
8.4	8.35	1.19	7.2	28.8	13.8	10.5
8.5	8.45	1.29	13.6	26.3	14.8	10.1

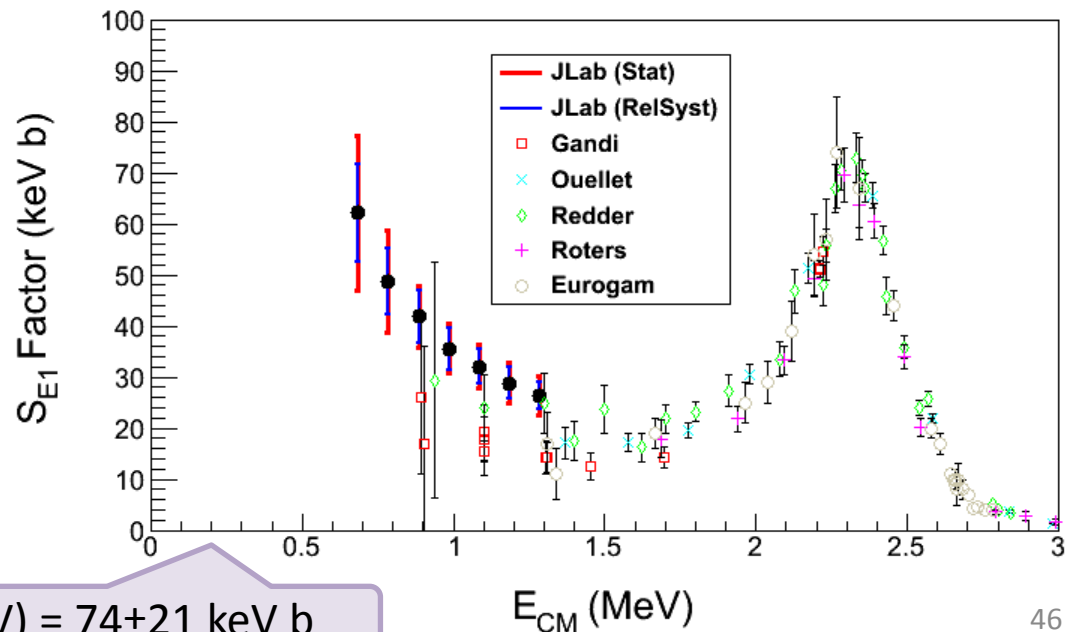

BACKGROUNDS

I. Background from oxygen isotopes and nitrogen in N₂O:

- $^{18}\text{O}(\gamma, \alpha)^{14}\text{C}$
- $^{17}\text{O}(\gamma, \alpha)^{13}\text{C}$
- $^{14}\text{N}(\gamma, p)^{13}\text{C}$

➤ Natural Abundance:

- I. ^{17}O : 0.038%
- II. ^{18}O : 0.205%

➤ Expected Rates:

- I. $^{17}\text{O}(\gamma, \alpha)^{13}\text{C}$, depletion=5,000
- II. $^{18}\text{O}(\gamma, \alpha)^{14}\text{C}$, depletion=5,000
- III. $^{14}\text{N}(\gamma, p)^{13}\text{C}$, detection eff.= 10^{-8}

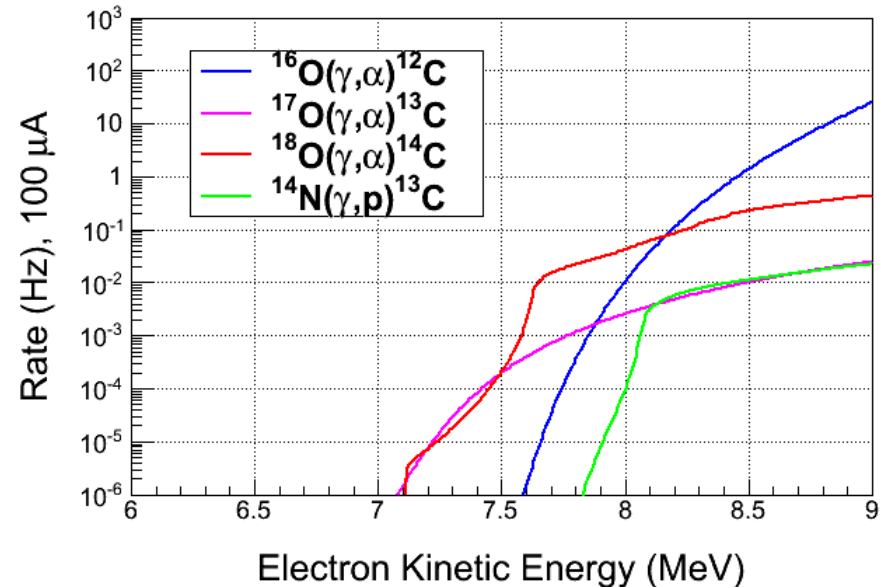
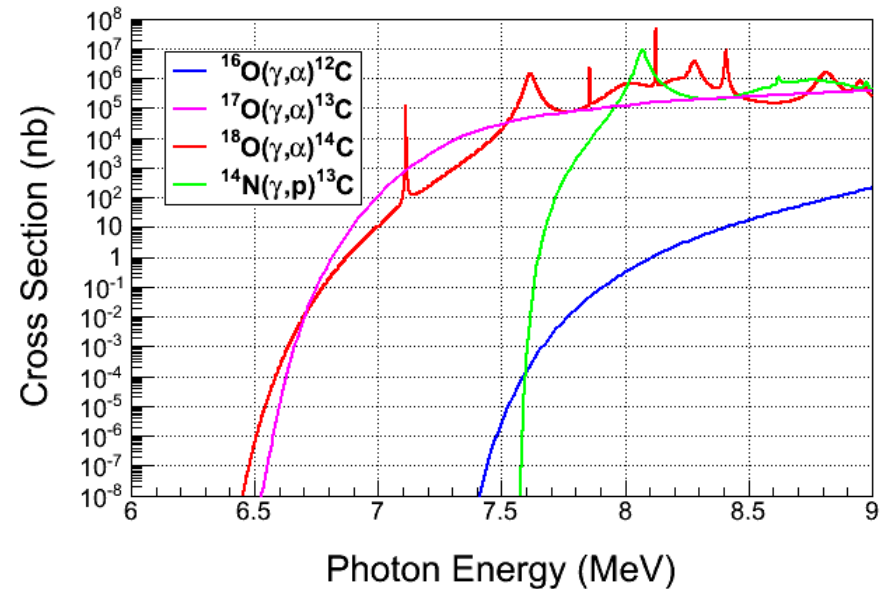

II. Background from:

- $^{17}\text{O}(\gamma,n)^{16}\text{O}$ and secondary (n,n) neutron-nucleus elastic scattering

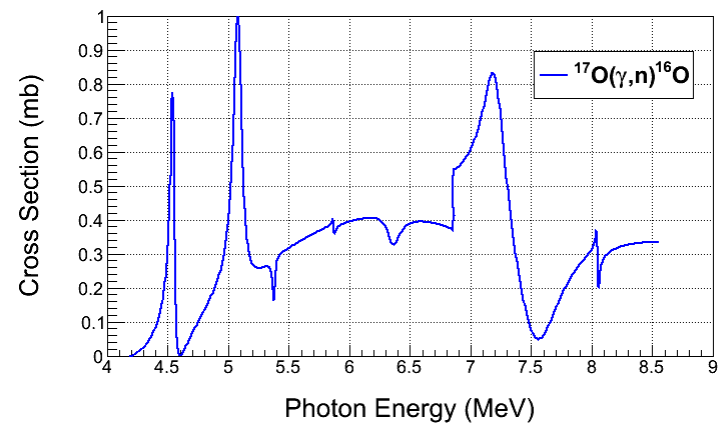

III. Cosmic-ray background:

- μ^\pm -nuclear
- neutron-nuclear elastic scattering

➤ Reject neutron background using the acoustic signal (500 factor)

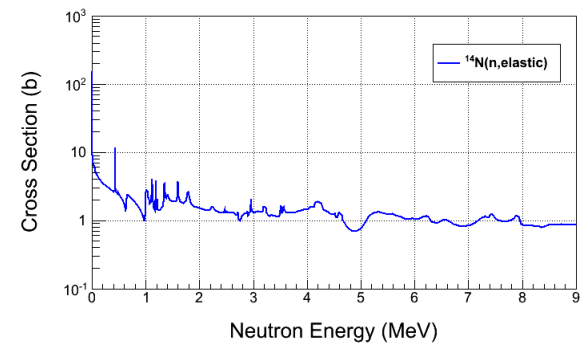
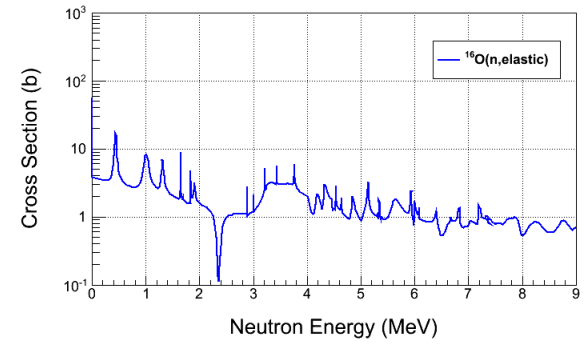

ION ENERGY DISTRIBUTIONS

➤ Suppress background
with Bubble Chamber threshold

➤ Calculated with Depletion:

- I. ^{17}O depletion = 5,000
- II. ^{18}O depletion = 5,000

➤ Threshold Efficiency (function of superheat):

Particle	Efficiency
e^\pm	$<10^{-11}$
γ	$<10^{-11}$
(γ, n)	2×10^{-3}

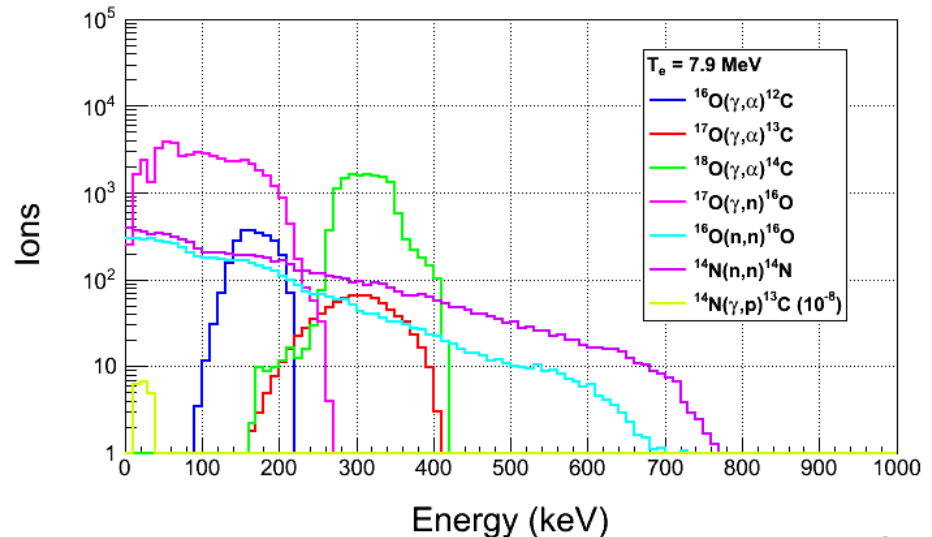
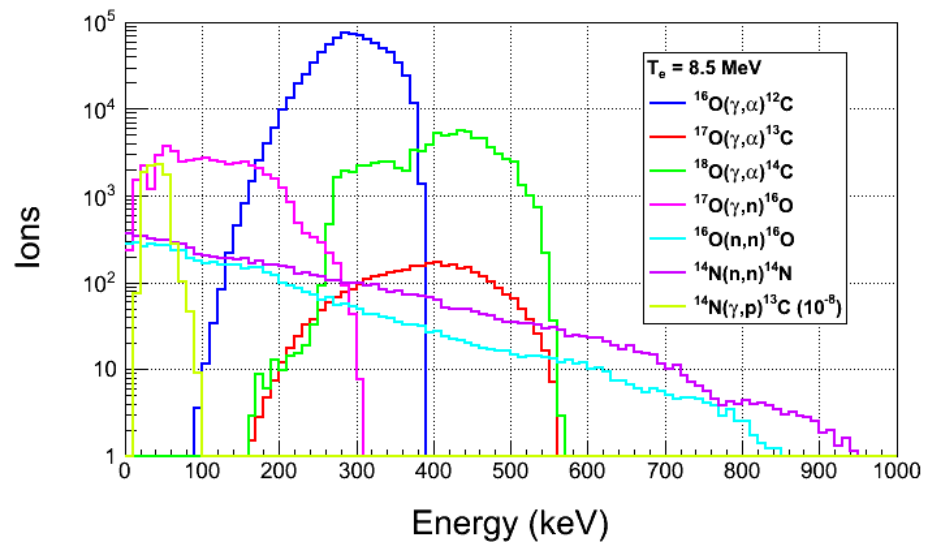

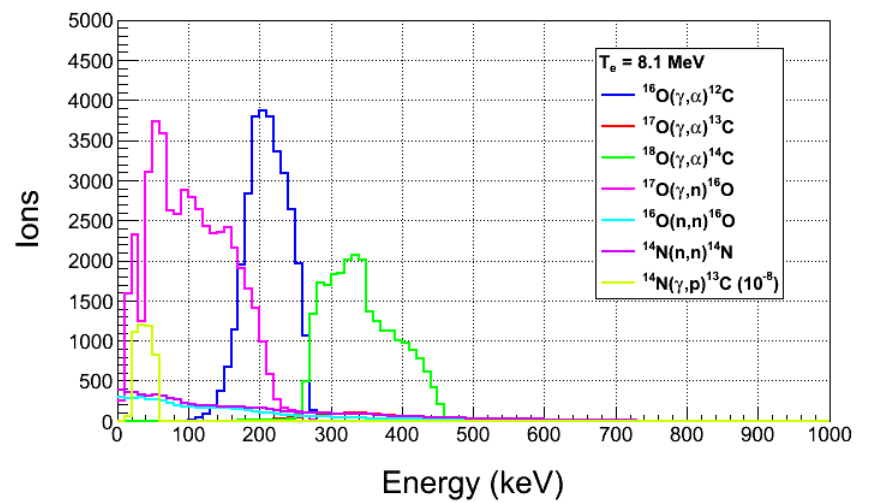
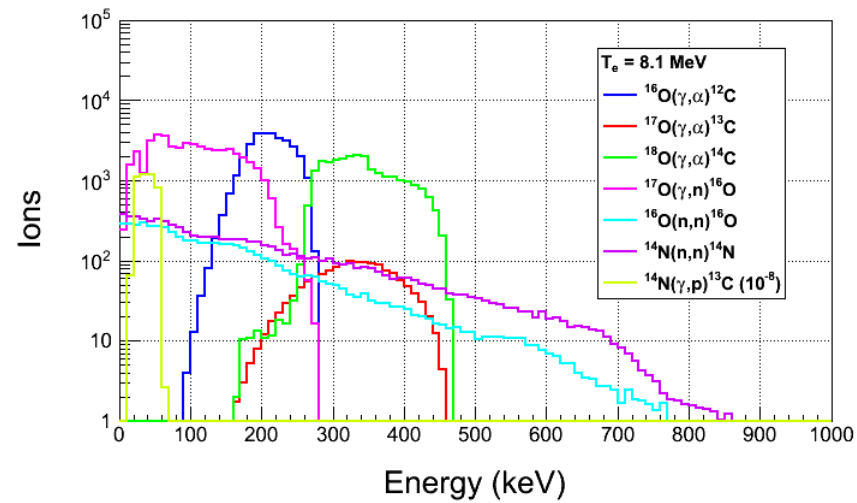
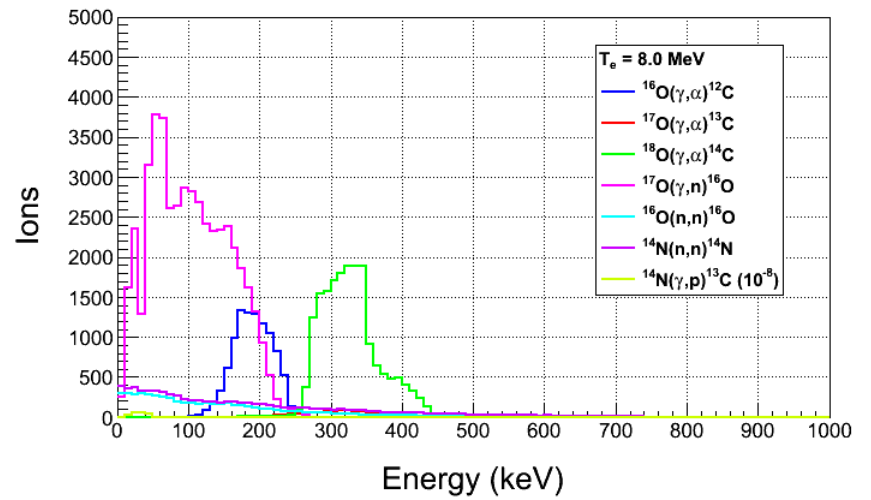
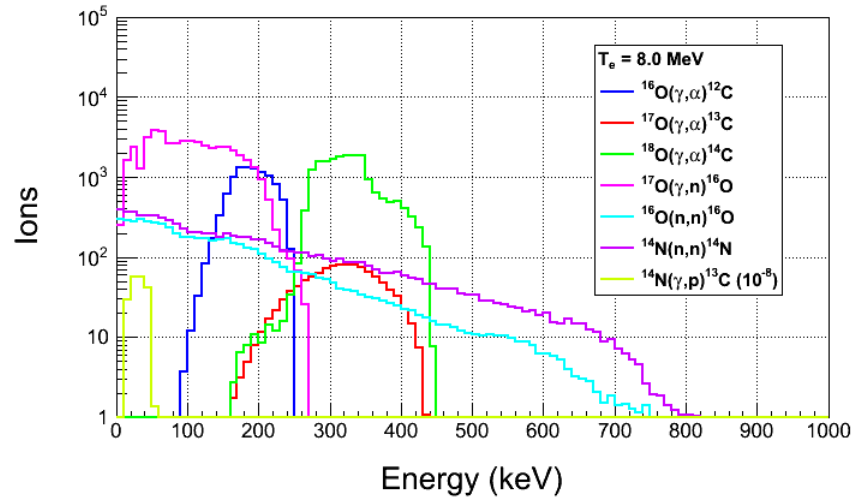

Gamma suppression

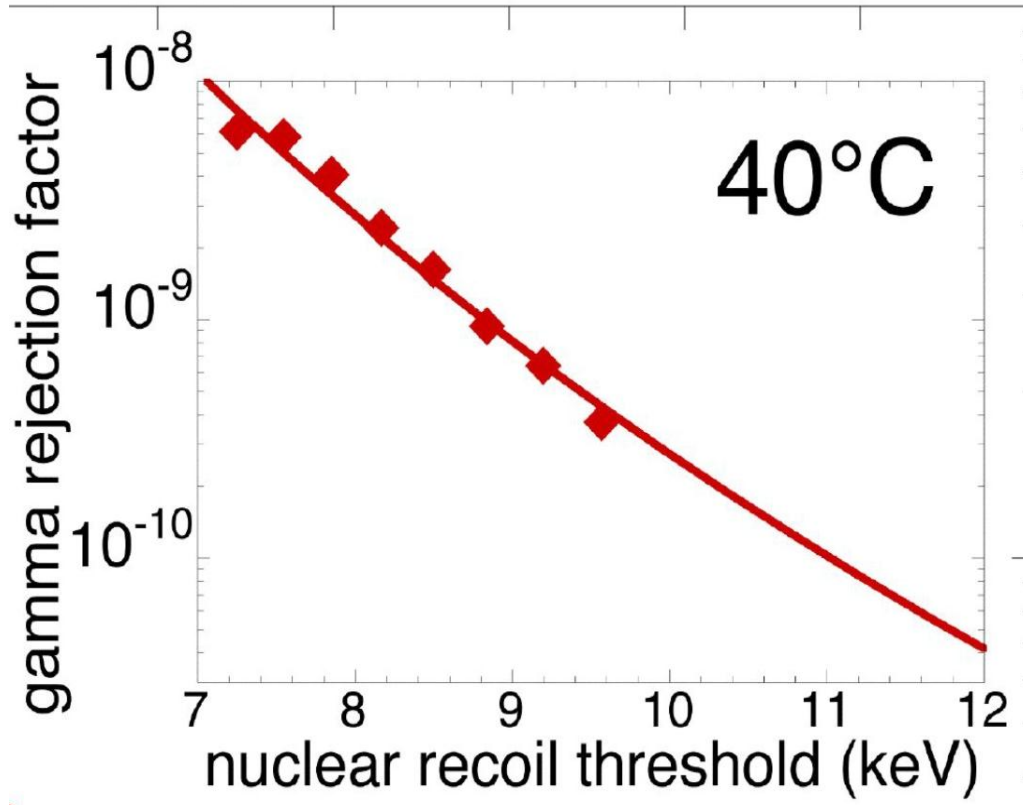

COUPP exp. FNAL

Bubble chamber basics

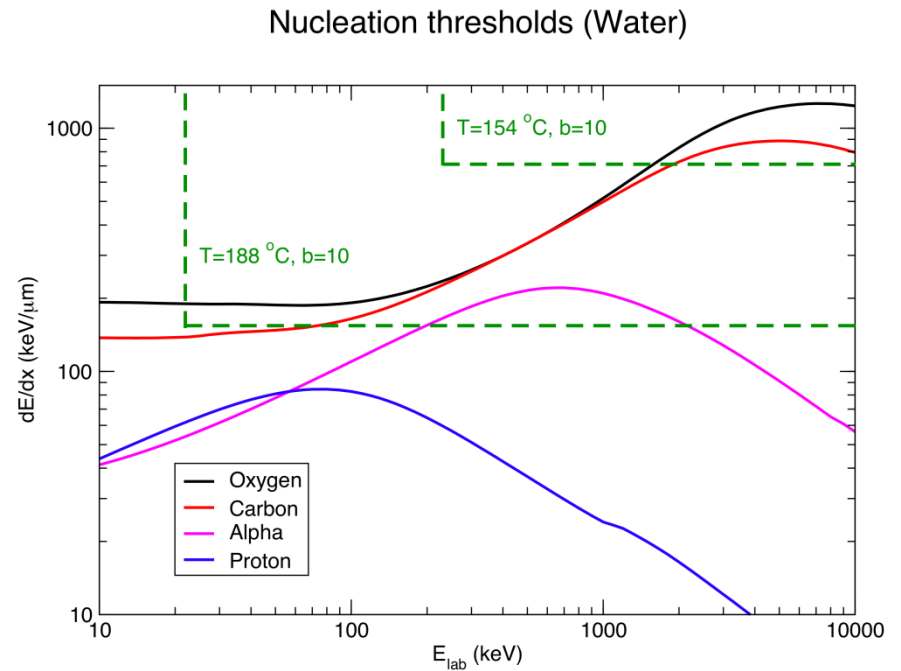
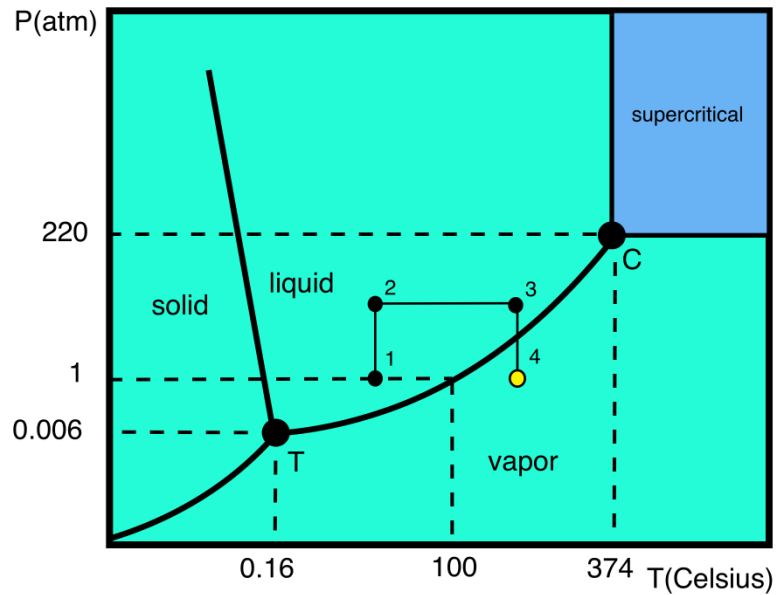

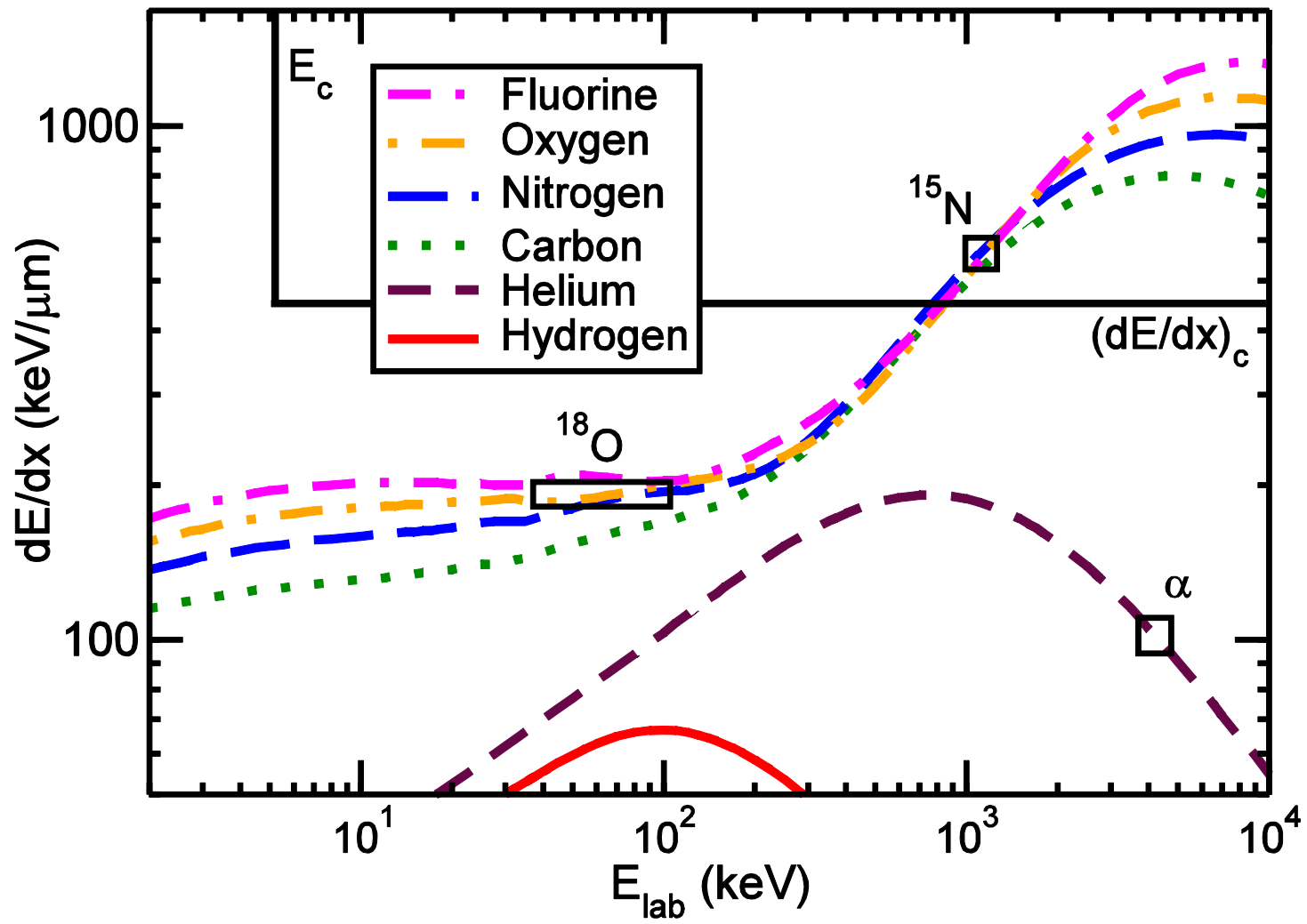

C_4F_{10} bubble chamber for JLab

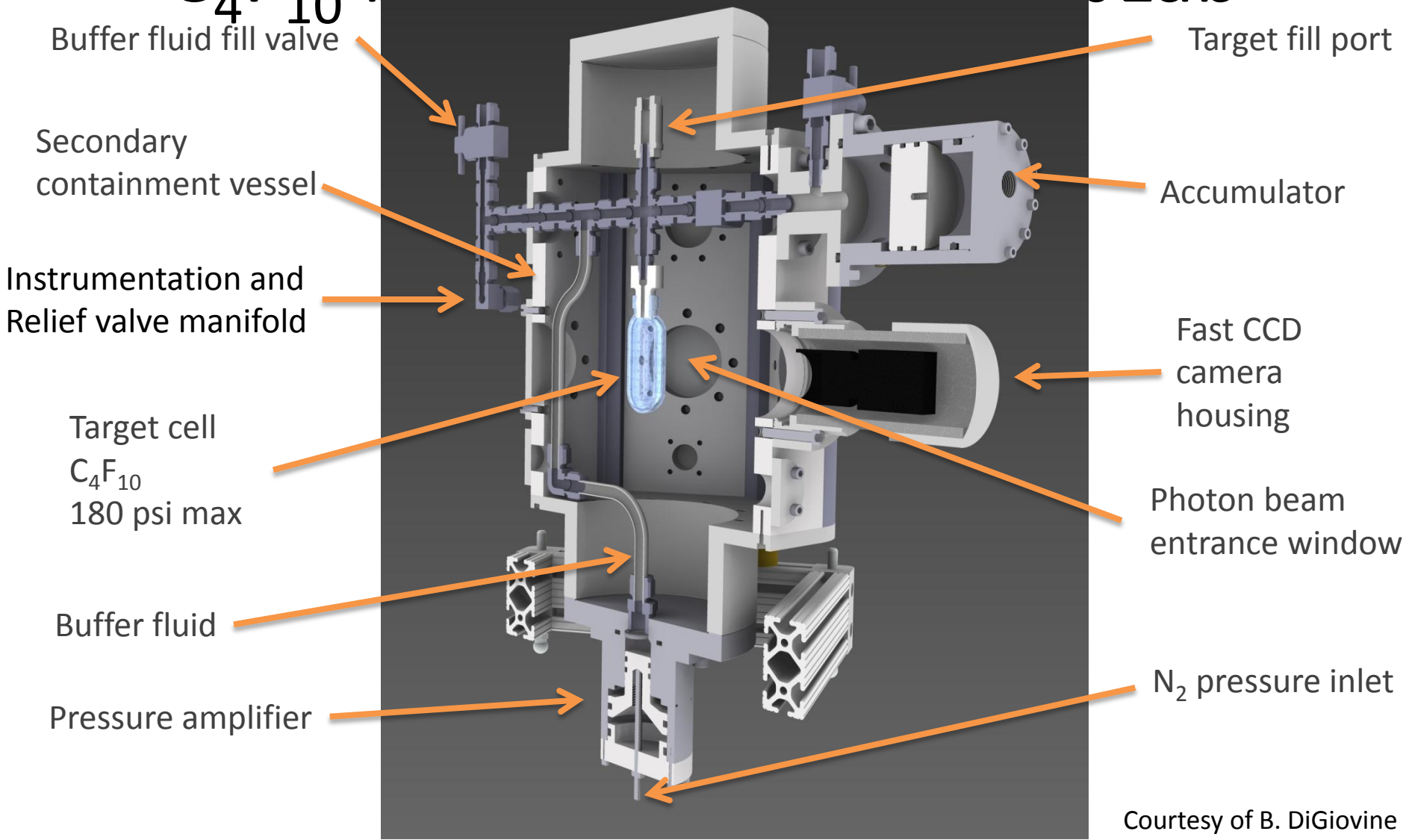

Courtesy of B. DiGiovine

SAFETY

➤ Super heated liquid N_2O , Nitrous oxide (laughing gas)

- I. At room temperature, it is a colorless, non-flammable gas, with a slightly sweet odor and taste

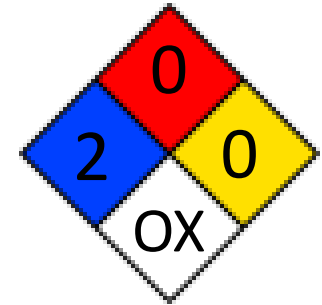

➤ High pressure system:

- I. Design Authority: Dave Meekins
- II. T =
- III. P =
- IV. Stored energy (N_2O is a gas)

➤ Buffer liquid: Mercury

- I. Closed system
- II. Volume: 135 mL

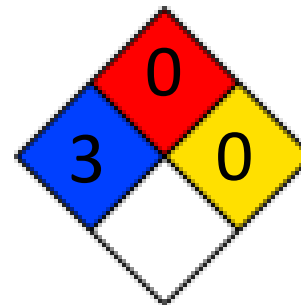

SUMMARY AND OUTLOOK

- Test N₂O Bubble Chamber at HIGS (February 2014)
- Perform $^{18}\text{O}(\gamma,\alpha)^{14}\text{C}$ and $^{17}\text{O}(\gamma,\alpha)^{13}\text{C}$ experiments at HIGS (Summer 2014)
- Test Bubble Chamber at JLab with Bremsstrahlung beam (October 2014)
- If successful, run depleted N₂O bubble chamber at JLab $^{16}\text{O}(\gamma,\alpha)^{12}\text{C}$

- Bubble Chamber issues:
 - Piezo–electric acoustical signal
 - Deadtime study (now $\tau \pm d\tau = 10.0 \pm 0.9$ s)
 - Measure O-isotope depletion

- Background tests:
 - Measure cosmic–ray background
 - Study chamber efficiency vs. superheat

BACKUP SLIDES

COST ESTIMATE

- I. New beamline components:
 - I. New Dipole Magnet and Hall Probe
 - II. 2 Super Harps
 - III. Fast Valve
- II. Summary of labor cost by group:

Group	Labor
Survey & Alignment	3 wks x 2
Magnet Test	1 wk x 2
Engineering Design	16 wks
Software	3 wks x 2
EES	6 wk x 2
EH&Q	4 wks

Item	Material Procurement	Shop	Labor
New Dipole Magnet	Dipole Magnet (\$8,000) Hall Probe System (\$10,000)		Design (2 week) Mapping (1 week) EESDC (1 week) Alignment (2 days)
New Beamline	2 Super Harps (20,000) Fast Valve (\$23,000)	Pipes + Pedestals (\$20,000)	Design (6 weeks) Alignment (1 week) Software (6 weeks) EES (6 weeks)
Radiator (cooled ladder, FSD)	0.02 and 0.10 mm Cu foils (\$2,000)	\$4,000	Design (2 week) Alignment (2 days)
Sweep Dipole			
Electron Dump	Pure Cu (\$5,000)	Dump + Pipes (\$15,000)	Design (4 weeks) Alignment (1 day)
Cu Collimator	Pure Cu (\$5,000)	Collimator + Stand (\$5,000)	Design (1 week) Alignment (1 day)
Photon Dump & Stand	Pure Al (\$3,000)	\$4,000	Design (1 week) Alignment (1 day)
Safety Review			4 weeks
Install			6 weeks
Bubble Chamber			Alignment (1 week)
Total	\$76,000	\$48,000	\$80,000
Indirect G&A (55.65%)	\$42,300	\$26,400	\$42,500
Indirect Stat & Fringe (57.15%)			\$45,700
Total	\$118,300	\$74,400	\$168,200

CO₂ SUPERHEATED LIQUID?

- Natural Abundance: ¹³C: 1.07%
- Depletion: ¹³C depletion=1,000
- ¹³C(γ ,n)¹²C Background

For comparison, ¹⁷O(γ ,n)¹⁶O

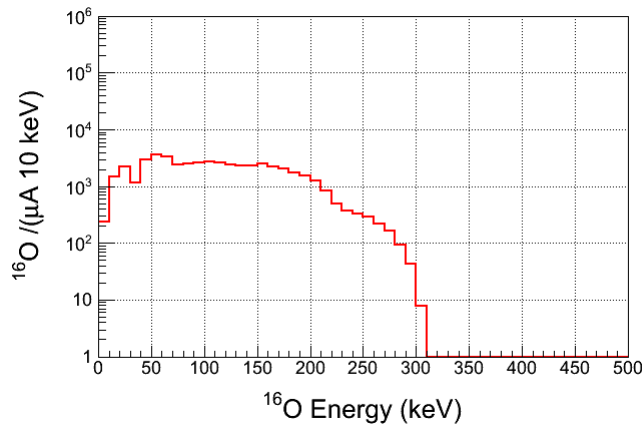

- ¹²C(γ ,2 α) α Background

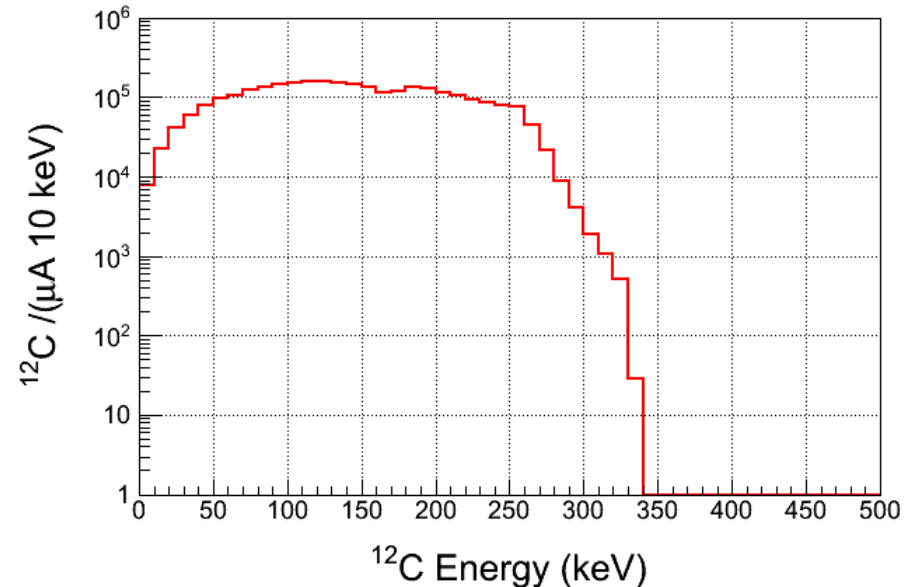
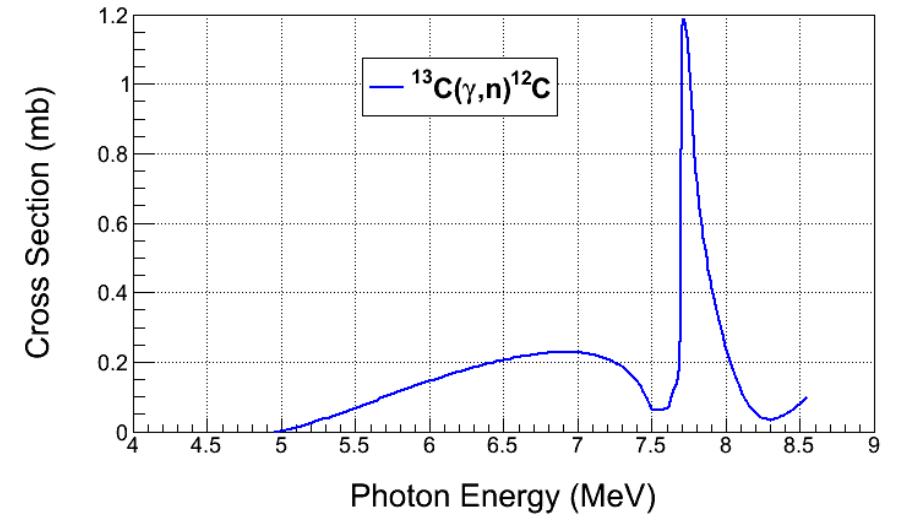

WATER SUPERHEATED LIQUID?

- etching of glass due to HF.
- With the Mercury as a buffer liquid, can we go back to water?

