

Measurement of $^{16}\text{O}(\gamma, \alpha)^{12}\text{C}$ with Bubble Chamber and
Bremsstrahlung Beam at Jefferson Lab Injector

Riad Suleiman

June 04, 2014





B. DiGiovine
D. Henderson
R. J. Holt
K. E. Rehm



A. Robinson
C. Ugalde



A. Sonnenschein



J. Benesch
P. Degtiarenko
A. Freyberger
J. Grames
G. Kharashvili
D. Meekins
M. Poelker
Y. Roblin
R. Suleiman
C. Tennant
V. Vylet

[https://wiki.jlab.org/ciswiki/index.php/Bubble Chamber](https://wiki.jlab.org/ciswiki/index.php/Bubble_Chamber)

OUTLINE

- Nucleosynthesis and the $^{12}\text{C}(\alpha, \gamma)^{16}\text{O}$ Reaction
- Time Reversal Reaction: $^{16}\text{O}(\gamma, \alpha)^{12}\text{C}$
- The Bubble Chamber
- Experimental Setup at Jefferson Lab Injector
- Bremsstrahlung Beam and Penfold-Leiss Unfolding
- Statistical and Systematic Errors
- Backgrounds and Ion Energy Distributions
- Summary and Outlook

RELATIVE ABUNDANCE OF ELEMENTS BY WEIGHT

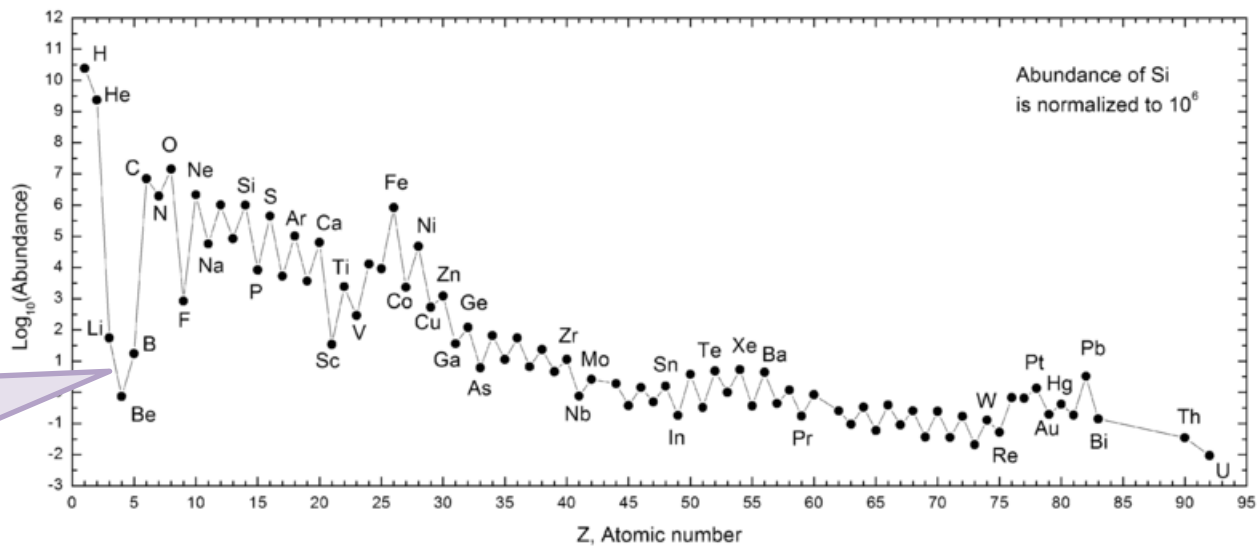
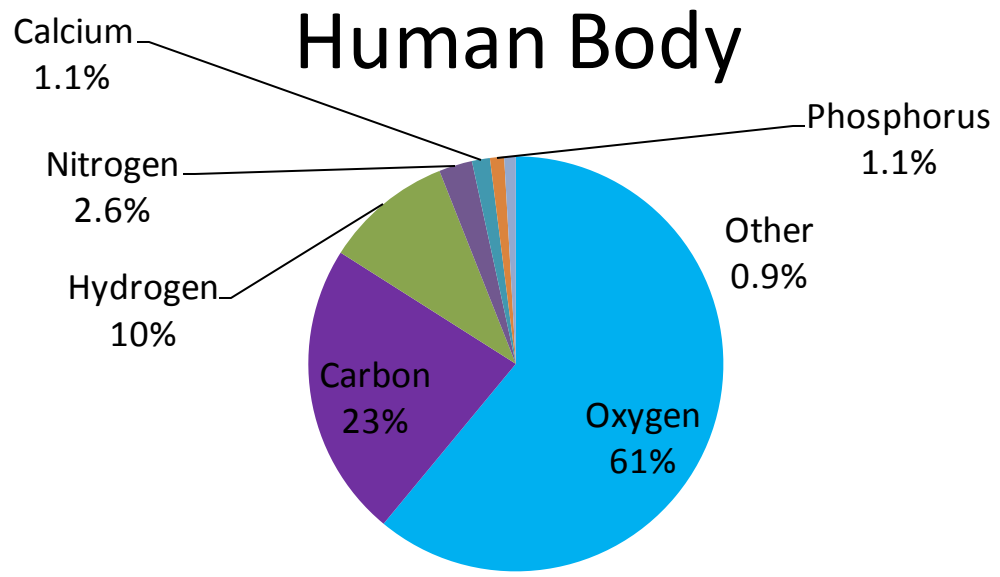
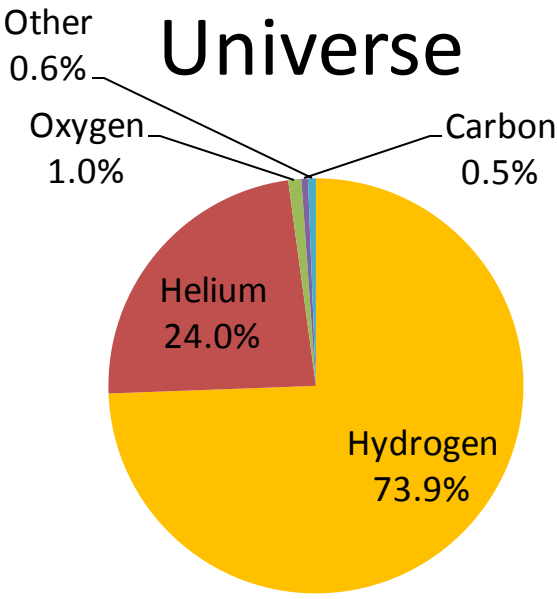

This region is bypassed by 3α process

NUCLEOSYNTHESIS

- Big Bang Nucleosynthesis: quark–gluon plasma \rightarrow p, n, He
- Stellar Nucleosynthesis: H burning, He burning, NCO cycle
- Supernovae Nucleosynthesis: Si burning
- Cosmic Ray Spallation

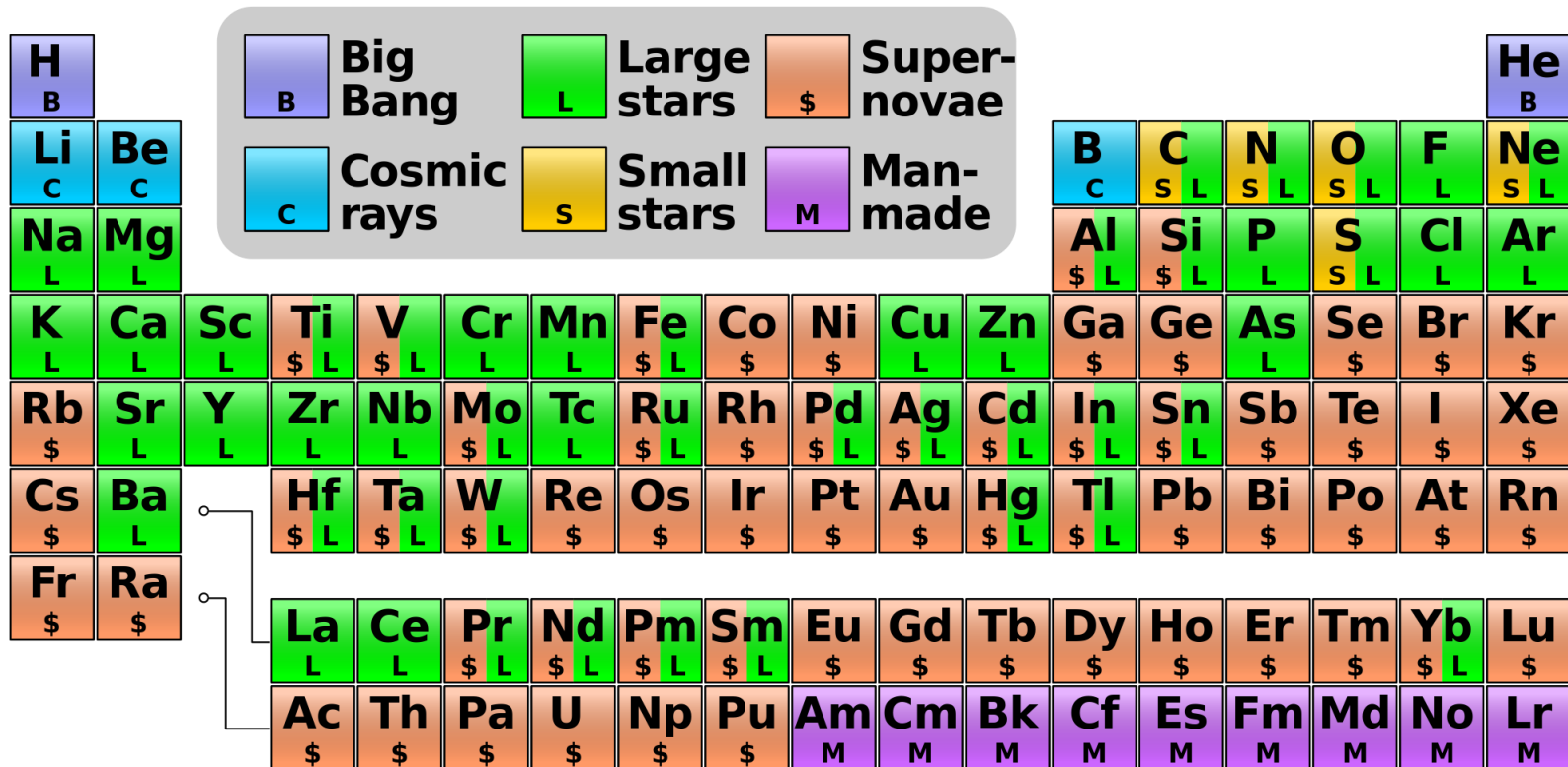

STELLAR HELIUM BURNING

The Triple Alpha Process
(Helium Fusion)

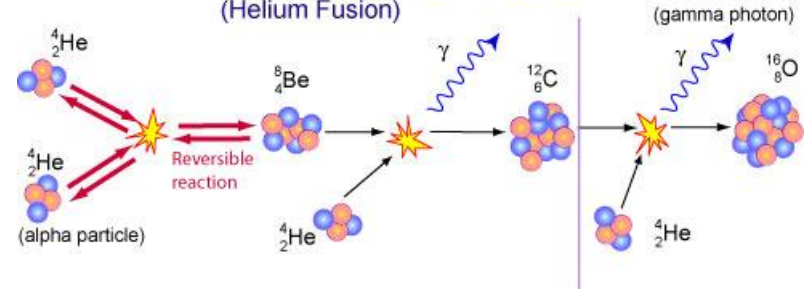

- Helium Reactions:



($Q = -0.092 \text{ MeV}$, $T_{1/2} \approx 10^{-16} \text{ s}$)

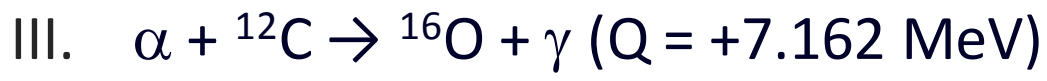

(slow, otherwise no ${}^{12}\text{C}$ remains)



- $\alpha + {}^{12}\text{C}$ burns at very small cross section $\sigma \approx 10^{-17} \text{ barn}$ (10^{-41} cm^2)

➔ Currently, reaction rate error is large ($\pm 35\%$)

Goal $< \pm 10\%$

- Thermonuclear reaction rate involving two nuclei is:

Only narrow energy range is relevant (Gamow Peak)

$$R = \sqrt{\frac{8}{\pi m (k_B T)^3}} \int_0^\infty E \sigma_{tot}(E) e^{-\frac{E}{k_B T}} dE$$

THE $^{12}\text{C}(\alpha,\gamma)^{16}\text{O}$ Reaction

- The *holy grail* of nuclear astrophysics

Periodic Table of the Elements

Affects the synthesis of most of the elements of the periodic table

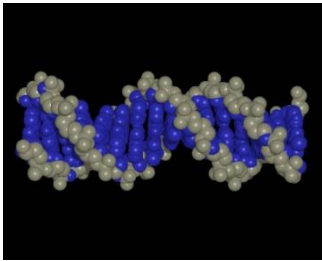

Sets the $N(^{12}\text{C})/N(^{16}\text{O})$ (≈ 0.4) ratio in the universe



Determines the minimum mass a star requires to become a supernova

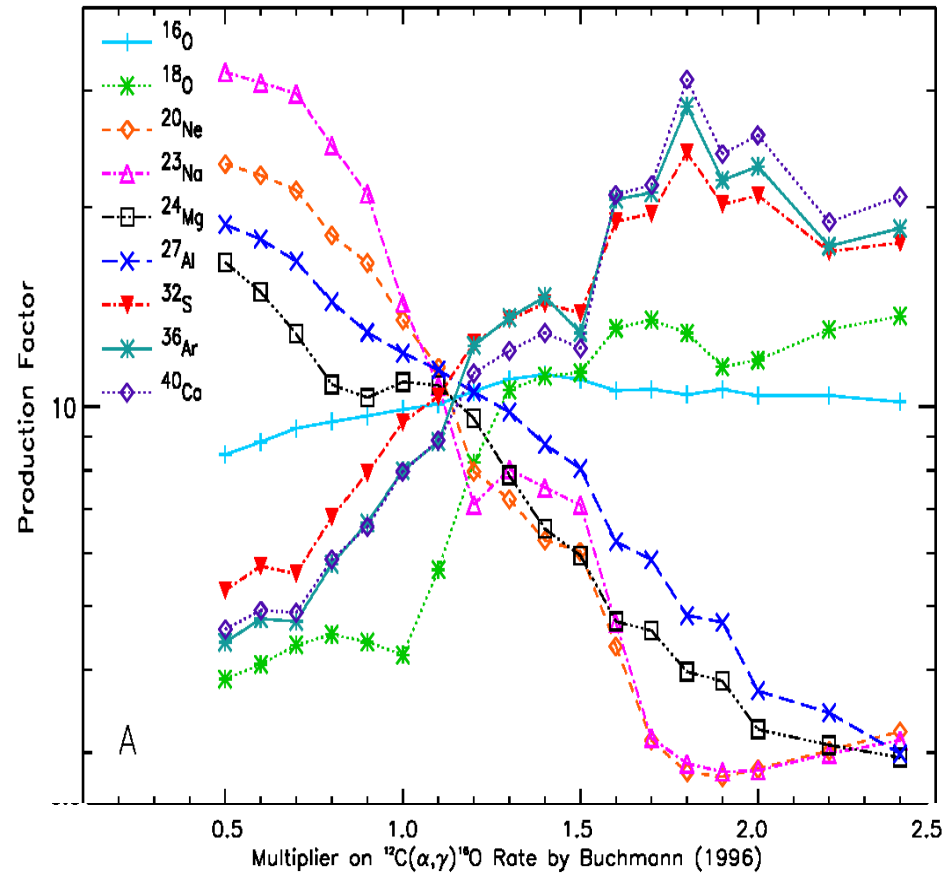

THE GAMOW PEAK (WINDOW)

- Narrow energy range where thermonuclear reactions is most likely to occur in stellar plasma is a product of two distributions:

- I. Maxwell-Boltzmann energy distribution with $e^{-E/k_B T}$
- II. Penetration through Coulomb barrier with $e^{-b/E^{1/2}}$

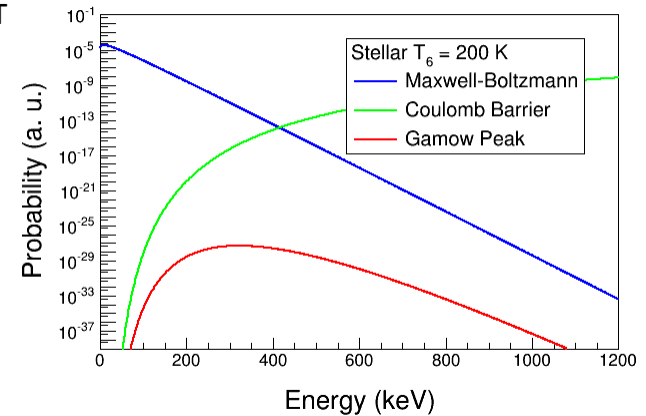

- For $\alpha + {}^{12}\text{C}$, and stellar $T=200 \cdot 10^6$ K:

➤ **Gamow Peak, $E_0 \approx 300$ keV, Width ≈ 50 keV**
(in Center-of-Mass (CM) of $\alpha + {}^{12}\text{C}$ system)

➤ Maximum of Maxwell-Boltzmann energy distribution, $k_B T = 17$ keV

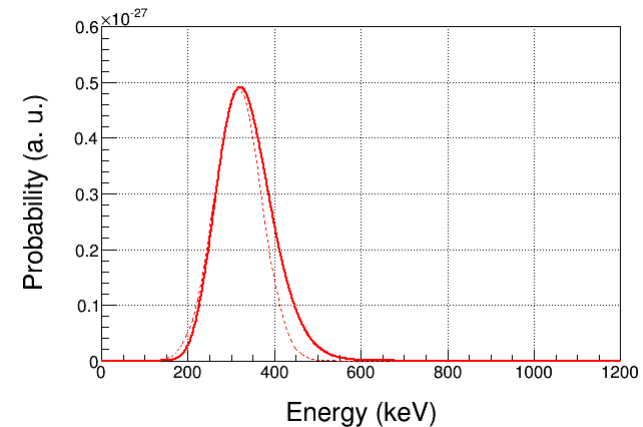

$\alpha + {}^{12}\text{C}$ REACTION

- α ($J^\pi=0^+$) + ${}^{12}\text{C}$ ($J^\pi=0^+$) cross section, $\sigma(E_0)$, is dominated by p -wave (E1) and d -wave (E2) radiative capture to ${}^{16}\text{O}$ ground state ($J^\pi=0^+$)
- Two bound states, at 6.92 MeV ($J^\pi=2^+$) and 7.12 MeV ($J^\pi=1^-$), with sub-threshold resonances at $E_R=-0.245$ and -0.045 MeV, provide most of $\sigma(E_0)$ through their finite widths
- Distinguish E1 and E2 by measuring γ -angular distributions

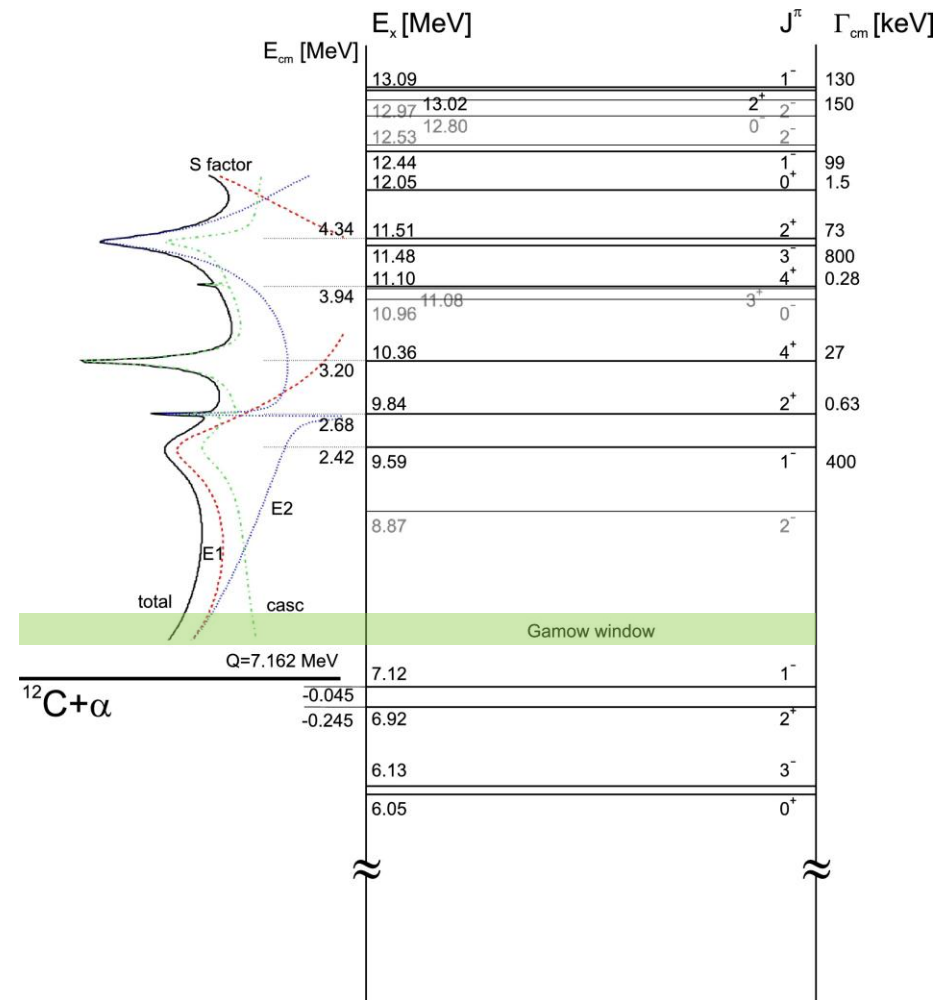

Heroic efforts in search of $^{12}\text{C}(\alpha,\gamma)^{16}\text{O}$

➤ Previous Experiments:

A. Direct Measurements:

- I. Helium ions on carbon target: $^{12}\text{C}(\alpha,\gamma)^{16}\text{O}$
- II. Carbon ions on helium gas: $^4\text{He}(^{12}\text{C}, \gamma)^{16}\text{O}$ or $^4\text{He}(^{12}\text{C}, ^{16}\text{O})\gamma$ (Schürmann)

Experiment	Beam Current (mA)	Target (nuclei/cm ²)	Time (h)
Redder	0.7	^{12}C , $3 \cdot 10^{18}$	900
Ouellet	0.03	^{12}C , $5 \cdot 10^{18}$	1950
Roters	0.02	^4He , $1 \cdot 10^{19}$	5000
Kunz	0.5	^{12}C , $3 \cdot 10^{18}$	700
EUROGAM	0.34	^{12}C , $1 \cdot 10^{19}$	2100
GANDI	0.6 (?)	^{12}C , $2 \cdot 10^{18}$?
Schürmann	0.01	^4He , $4 \cdot 10^{17}$?
Plag	0.005	^{12}C , $6 \cdot 10^{18}$	278

B. Indirect Measurements:

- I. β -delayed α decay of ^{16}N ($J^\pi=2^-$, $T_{1/2}=7.13$ s, BR=0.12%)
 $^{16}\text{N} \rightarrow \beta^- + ^{16}\text{O}^* (J^\pi=1^-) \rightarrow \alpha + ^{12}\text{C}$

ASTROPHYSICAL S-FACTOR $^{12}\text{C}(\alpha,\gamma)^{16}\text{O}$

- Define *S-Factor* to remove both $1/E$ dependence of nuclear cross sections and Coulomb barrier transmission probability:

$$S \equiv E_{CM} \sigma(\alpha, \gamma) e^{2\pi\eta}$$

$$\eta = \frac{1}{137} Z_{\alpha} Z_{^{12}\text{C}} \sqrt{\frac{m_{^{12}\text{C}\alpha}}{2E_{CM}}}$$

Author	$S_{\text{tot}}(300)$ (keV b)
Hammer (2005)	162 ± 39
Kunz (2001)	165 ± 50

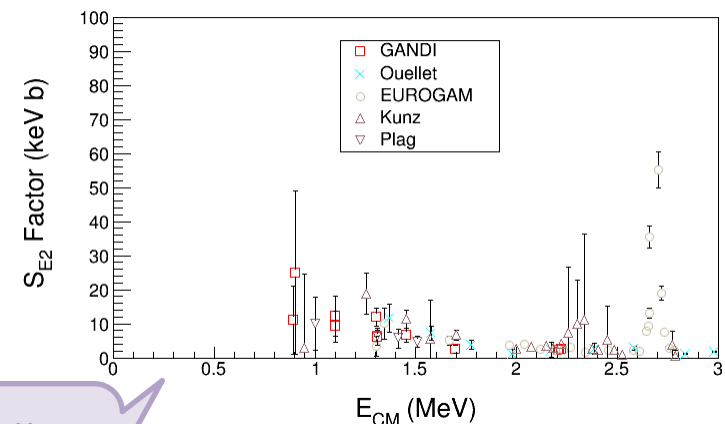
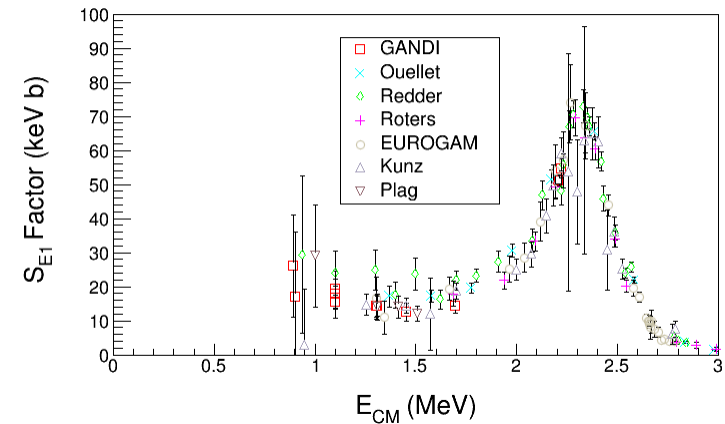

R-matrix Extrapolation to stellar helium burning at $E = 300$ keV

TIME REVERSAL REACTION

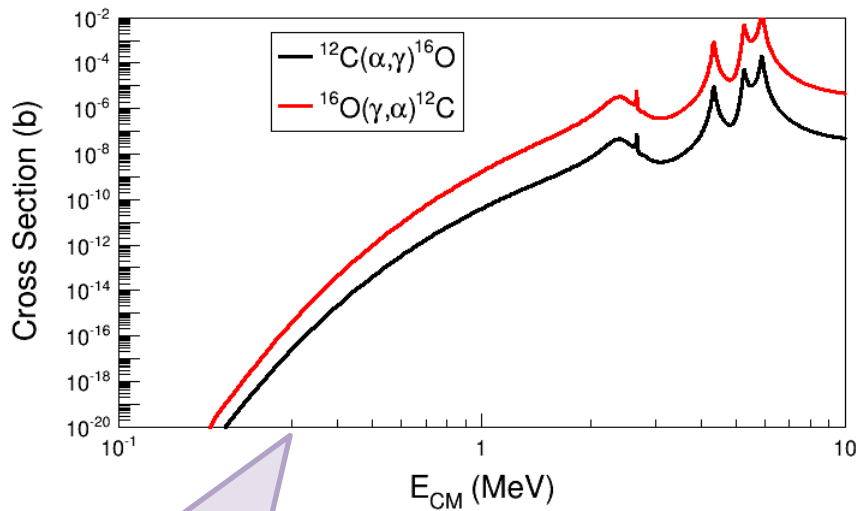
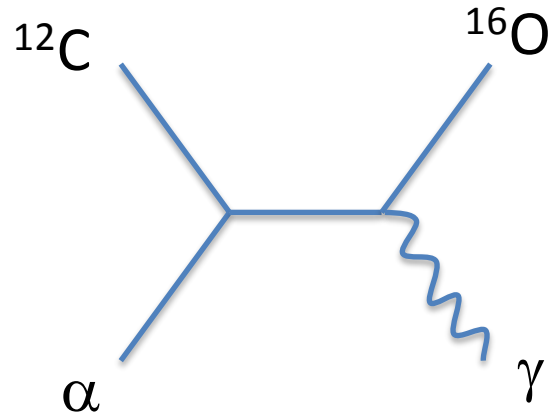

Stellar helium burning
at $E = 300 \text{ keV}$

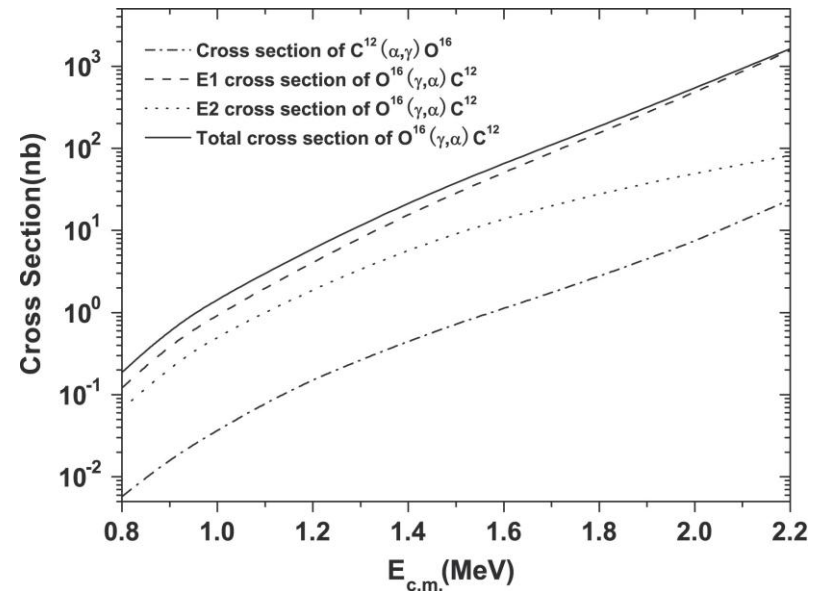

RECIPROCITY RELATION: (γ, α) and (α, γ)

➤ $A(\alpha, \gamma)B$:

$$\sigma_{B\gamma}^{j \rightarrow i}(E_\gamma) = \frac{(2J_i + 1)(2J_\alpha + 1)}{2J_j + 1} \frac{m_{A\alpha} c^2 E_{A\alpha}}{E_\gamma^2} \sigma_{A\alpha}^{i \rightarrow j}(E_{A\alpha})$$

$$m_{A\alpha} c^2 = \frac{M(^{12}\text{C}) \cdot M(\alpha)}{M(^{12}\text{C}) + M(\alpha)} = 2796 \text{ MeV} \quad J_i = 0, J_j = 0, J_\alpha = 0$$

$$E_{A\alpha} = E_{CM}$$

$$Q = m_A + m_\alpha - m_B = +7.162 \text{ MeV}$$

$$E_{CM} = \sqrt{m_B^2 + 2E_\gamma m_B} - m_B - Q$$

$$E_\gamma \cong E_{CM} + Q$$

$$\sigma_{(\gamma, \alpha)}(E_\gamma) = \frac{m_{A\alpha} c^2 E_{CM}}{E_\gamma^2} \sigma_{(\alpha, \gamma)}(E_{CM})$$

➤ $\sigma(\gamma, \alpha)$ is over two orders of magnitude larger than $\sigma(\alpha, \gamma)$

NEW APPROACH: REVERSAL REACTION + BUBBLE CHAMBER

- Extra gain (factor of 100) by measuring time reversal reaction
- Target density up to 10^4 higher than conventional targets. Number of ^{16}O nuclei = $3.5 \cdot 10^{22} / \text{cm}^2$ (3.0 cm cell)
- Measures total cross section σ_{tot} (or S_{tot})
- Solid Angle and Detector Efficiency = 100%
- Electromagnetic debris (electrons and gammas, or positrons) do NOT trigger nucleation (detector is insensitive to γ -rays by at least 1 part in 10^{11}).

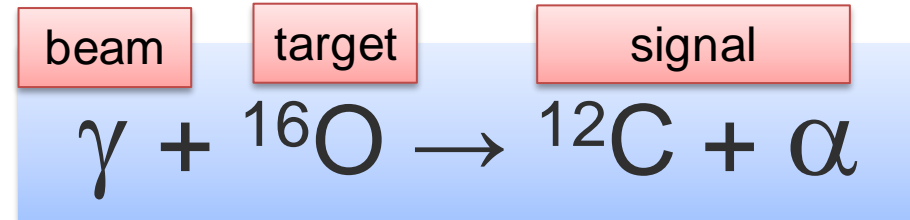

- Monochromatic γ beam at HIGS $\approx 10^{7-8} \gamma/\text{s}$
- Bremsstrahlung at JLab $\approx 10^9 \gamma/\text{s}$ (top 250 keV)

THE BUBBLE CHAMBER

- Donald Glaser won Nobel Prize for inventing chamber to detect particles (1960)
- Now being used in Dark Matter Search Experiments: COUPP, PICASSO, SIMPLE
- Superheat Preparation:

- Liquid is pressurized at ambient temperature (1 to 2)
- Then pressure is kept constant while temperature is increased to above boiling point (2 to 3)
- Finally pressure is slowly released while keeping temperature constant (3 to 4)
- At this point (4), still liquid but now superheated

- Bubble Formation:

- Particle energy loss will induce vaporization
- Resultant vapor bubble is observable either **visibly** or **audibly**
- Bubble growth is captured by a digital camera
- Pressure is increased (4 to 3) to quench bubble. It takes about a second for liquid to return to a stable state
- Superheat is restored by releasing pressure again (3 to 4), and cycle is repeated for each bubble event

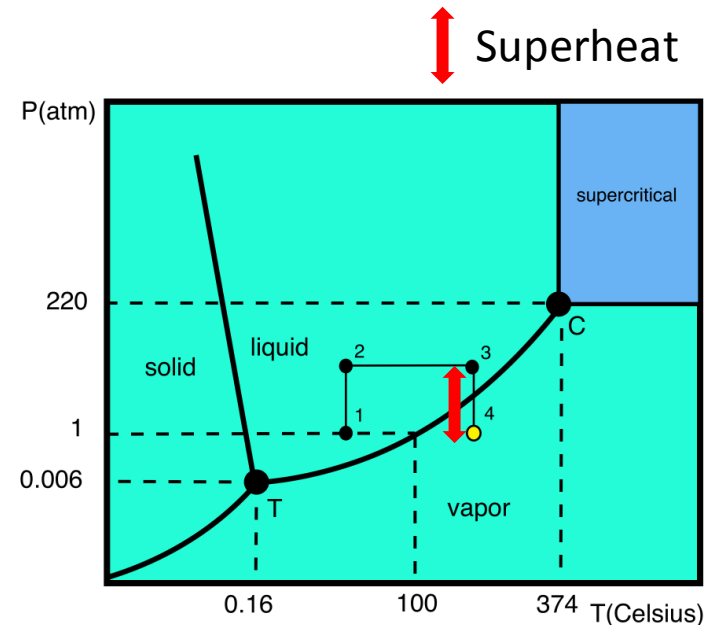

BUBBLE GROWTH AND QUENCHING

$^{19}\text{F}(\gamma, \alpha)^{15}\text{N}$ event in C_4F_{10} at HIGS

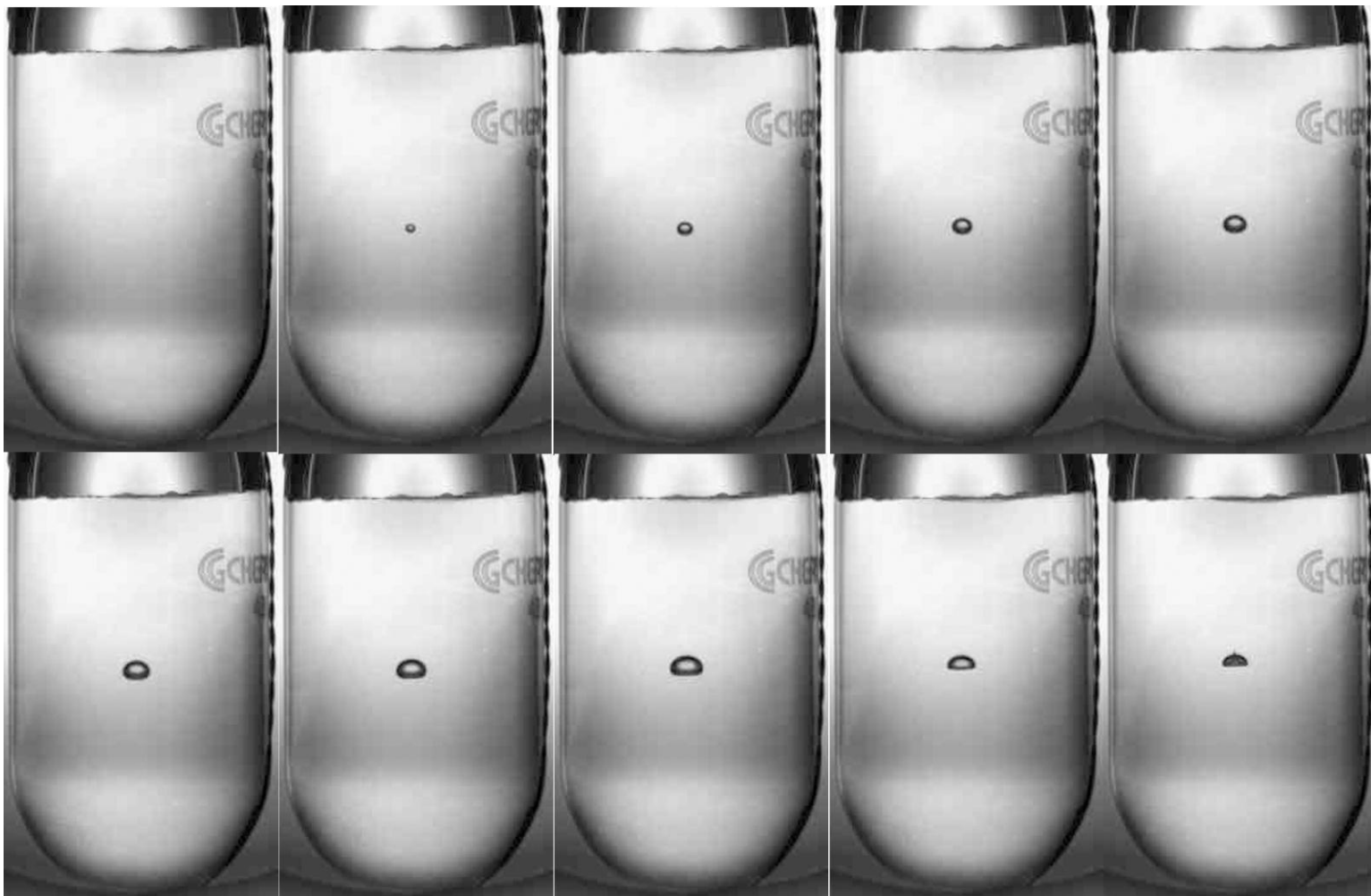

3.0 cm

100 Hz Digital Camera: $\Delta t = 10$ ms

ACOUSTIC SIGNAL DISCRIMINATION

I. Bubble growth produces an audible click which is recorded by piezo-electric transducers

II. Neutron Events:

I. $^{17}\text{O}(\gamma, n)^{16}\text{O}$

II. Neutron–nucleus elastic scattering:
 $^{16}\text{O}(n, n)$, $^{14}\text{N}(n, n)$

Ions ^{16}O or ^{14}N will generate a single bubble

III. Alpha Events:

I. $^{16}\text{O}(\gamma, \alpha)^{12}\text{C}$

II. $^{17}\text{O}(\gamma, \alpha)^{13}\text{C}$

III. $^{18}\text{O}(\gamma, \alpha)^{14}\text{C}$

Ions $^{12}\text{C}+\alpha$ or $^{13}\text{C}+\alpha$ or $^{14}\text{C}+\alpha$ will generate a combined multi-bubble

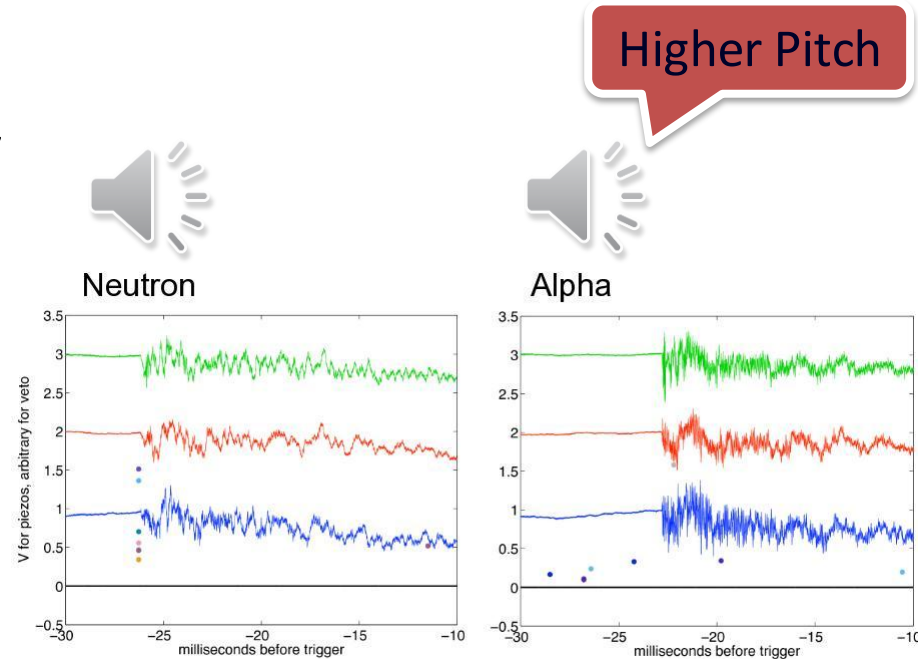

COUPP, FNAL, courtesy of A. Sonnenschein

Suppress neutron events
by 100 using acoustic
signal

BUBBLE CHAMBER AT HIGS

- I. High Intensity Gamma Source (HIGS) at Duke University
- II. γ -rays generated by Compton backscattering of free-electron-laser (FEL) light from high-energy electron beam bunches

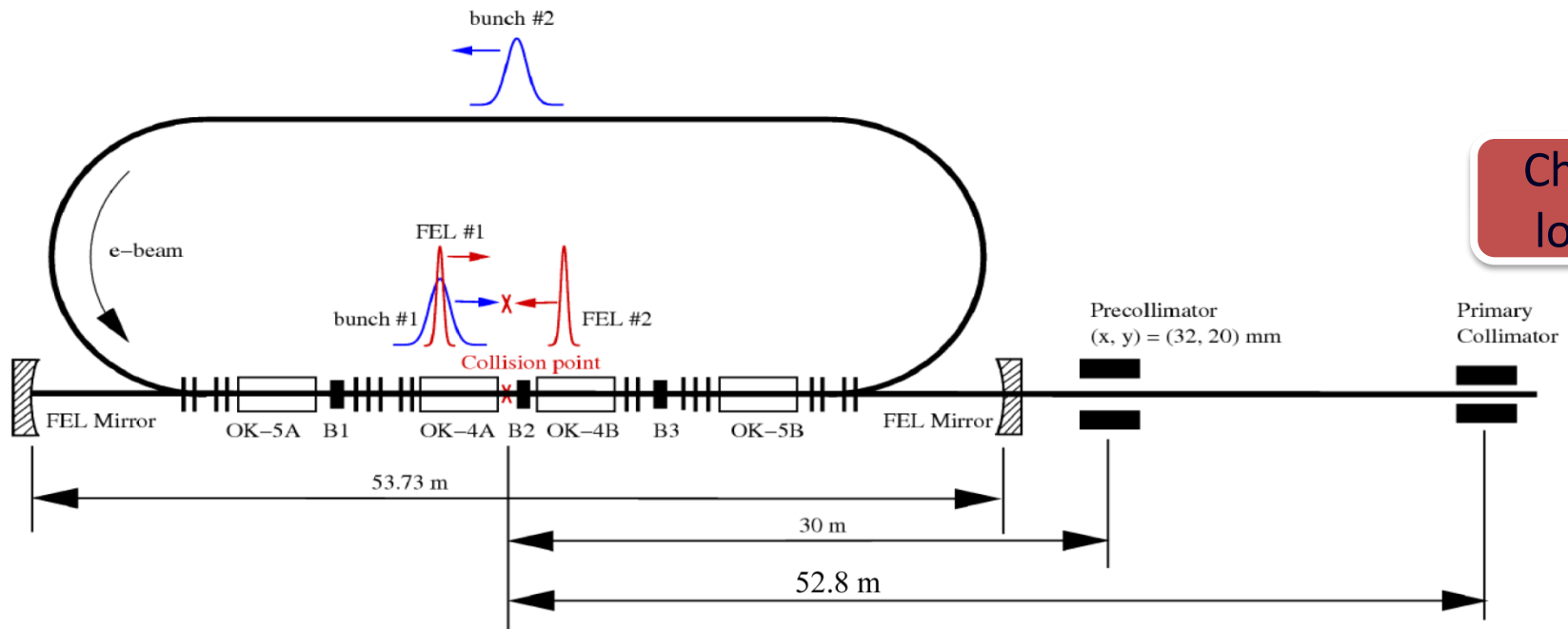

MEASURING $^{19}\text{F}(\gamma, \alpha)^{15}\text{N}$ AT HIGS

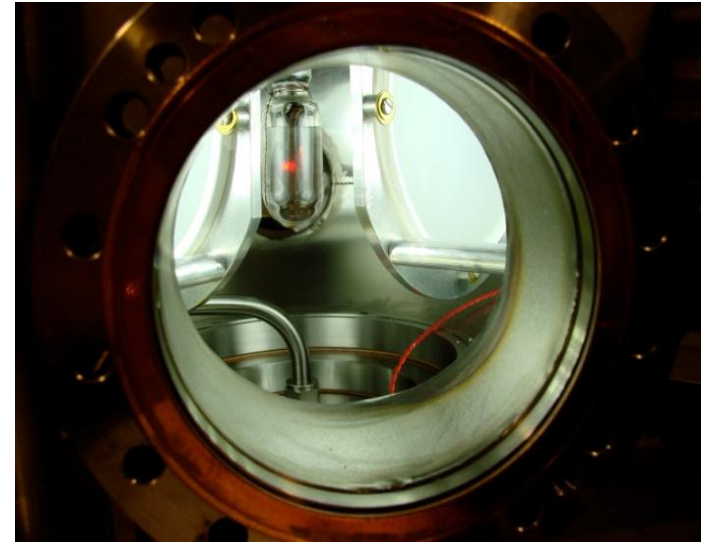
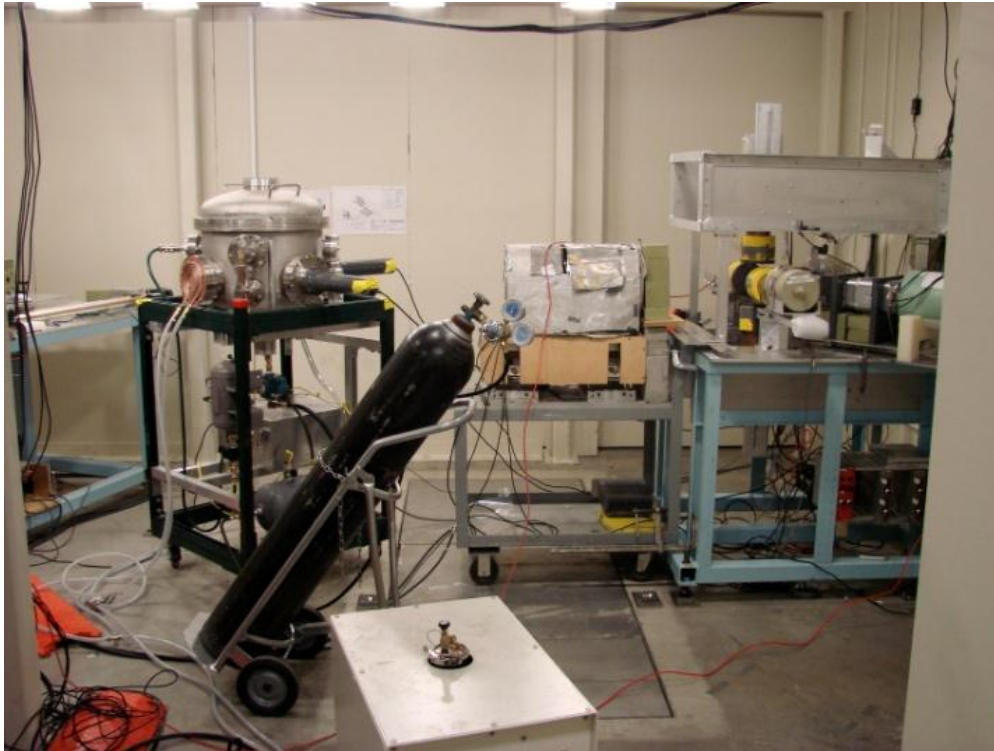

C_4F_{10} Bubble Chamber

$T = 30^\circ\text{C}$

$P = 3 \text{ atm}$

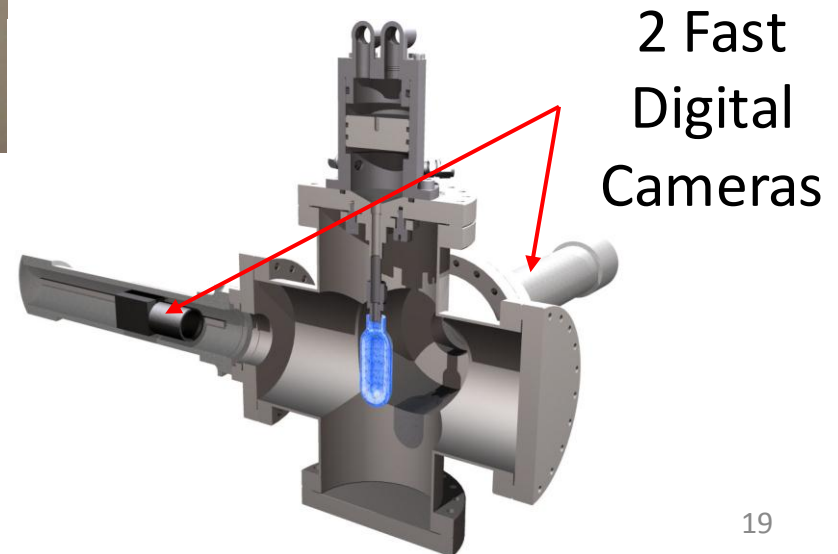



Contents lists available at SciVerse ScienceDirect

Physics Letters B

www.elsevier.com/locate/physletb



First determination of an astrophysical cross section with a bubble chamber: The $^{15}\text{N}(\alpha, \gamma)^{19}\text{F}$ reaction

C. Ugalde ^{a,*}, B. DiGiovine ^b, D. Henderson ^b, R.J. Holt ^b, K.E. Rehm ^b, A. Sonnenschein ^c, A. Robinson ^d,
R. Raut ^{e,f,1}, G. Rusev ^{e,f,2}, A.P. Tonchev ^{e,f,3}

^a Department of Astronomy and Astrophysics, University of Chicago, Chicago, IL 60637, USA

^b Physics Division, Argonne National Laboratory, Argonne, IL 60439, USA

^c Fermi National Accelerator Laboratory, Batavia, IL 60510, USA

^d Department of Physics, University of Chicago, Chicago, IL 60637, USA

^e Department of Physics, Duke University, Durham, NC 27708, USA

^f Triangle Universities Nuclear Laboratory, Durham, NC 27708, USA

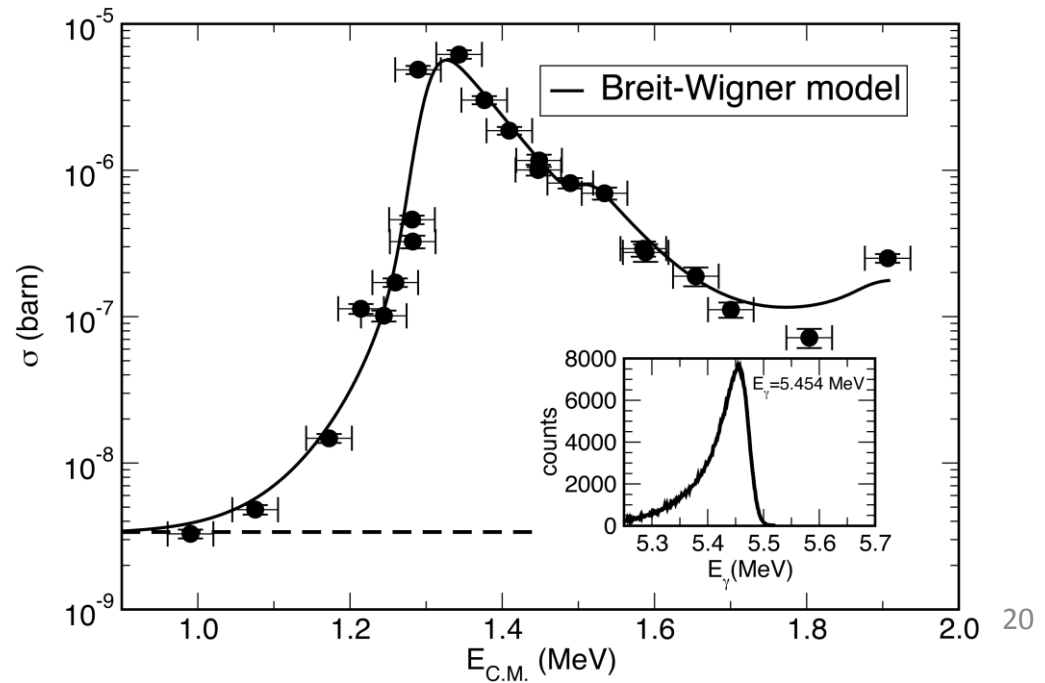
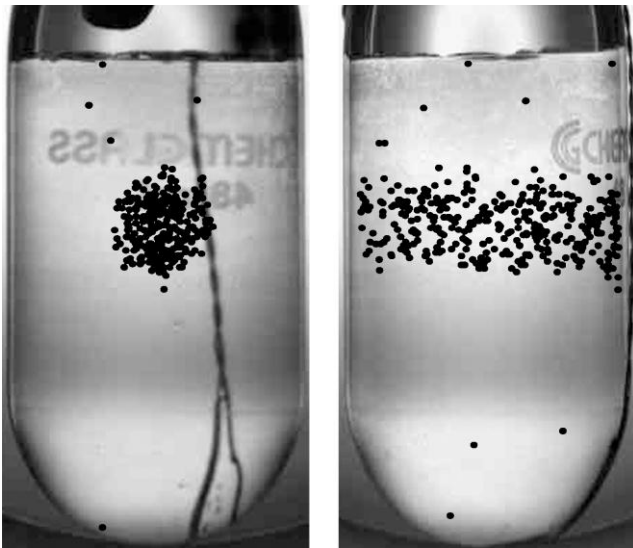

BREMSSTRAHLUNG BACKGROUND AT HIGS

Electron Beam Energy: 400 MeV

Electron Beam Current: 41 mA

Interaction Length: 35 m

Vacuum: 2×10^{-10} Torr

Residual Gas: $Z = 10$



Strong Bremsstrahlung
Background
(when coupled with large
cross sections at high energies)

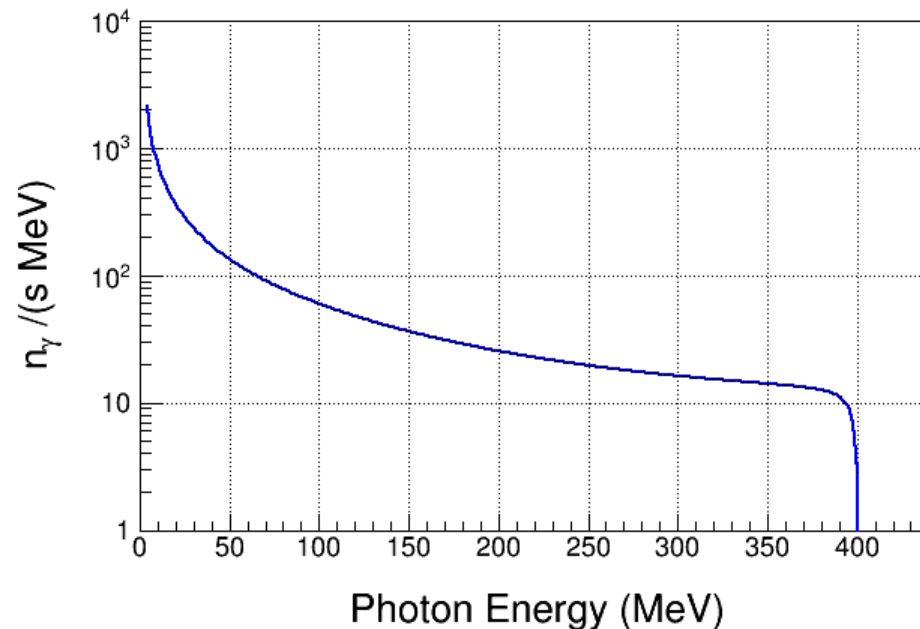

N_2O (LAUGHING GAS) BUBBLE CHAMBER

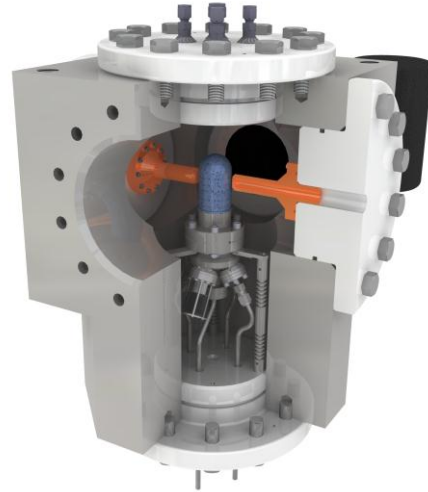
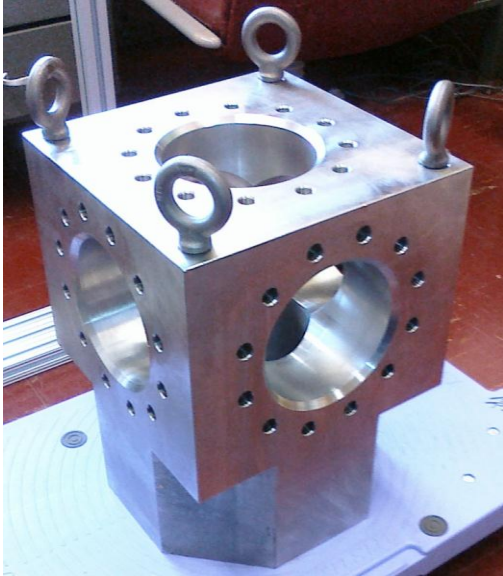

$T = -5^\circ\text{C}$

$P = 60\text{ atm}$

First $\gamma + O \rightarrow \alpha + C$ bubble
HIGS, April 2013

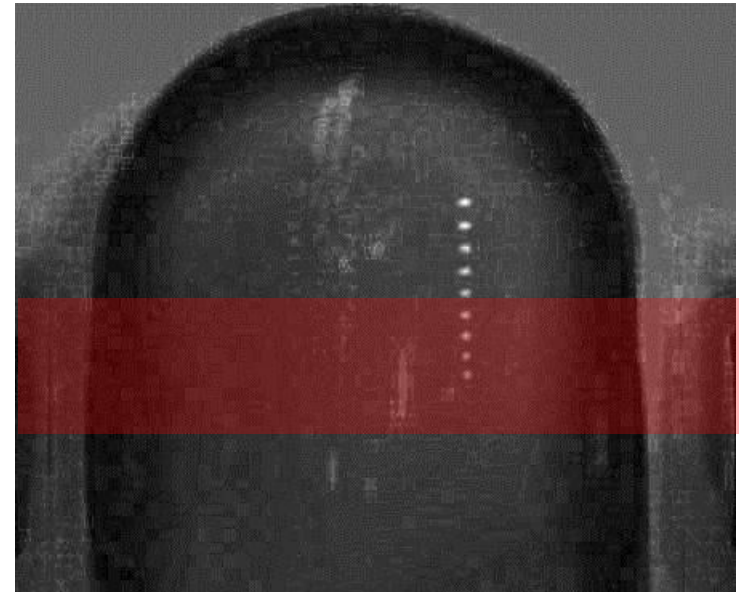
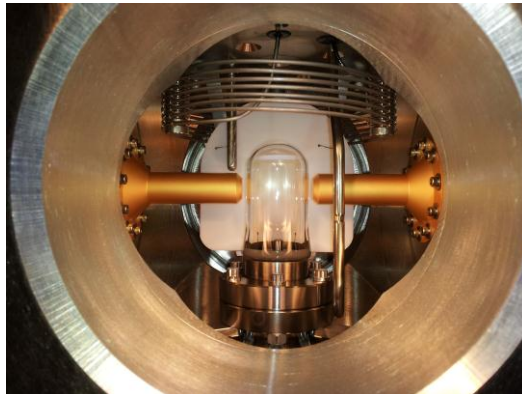

BUBBLE CHAMBER PRINCIPLE

I. For bubble formation, particle must be over thresholds in both **E** and **dE/dx**

$$E \geq E_c = \frac{4}{3} \pi R_c^3 (\rho h + P_l) + 4\pi R_c^2 \left(s - T \frac{\partial s}{\partial T} \right)$$

II. Only bubbles with $r > R_c$ grow to be macroscopic

$$R_c = 2s / (P_v - P_l)$$

s : Surface tension

III. Bubble requires minimum deposited energy (E_c) within minimum distance L_c ($=aR_c$, 10s of nm to a few μm)

$$\frac{dE}{dx} > \left(\frac{dE}{dx} \right)_c = \frac{E_c}{aR_c}$$

a : free parameter (to determined experimentally)

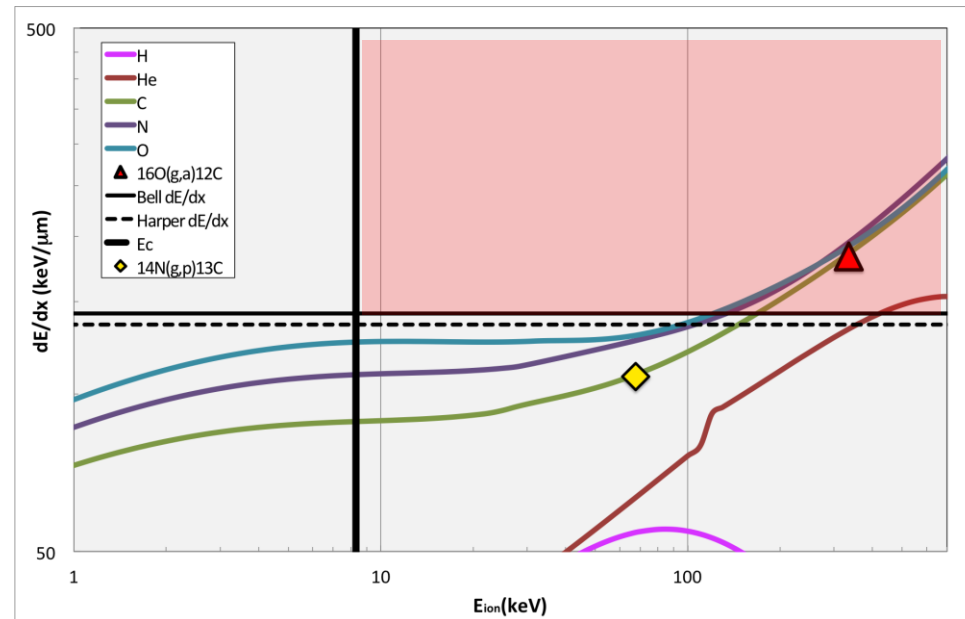

EFFICIENCY CURVE

N_2O thresholds
Superheat = $3.3^\circ C$

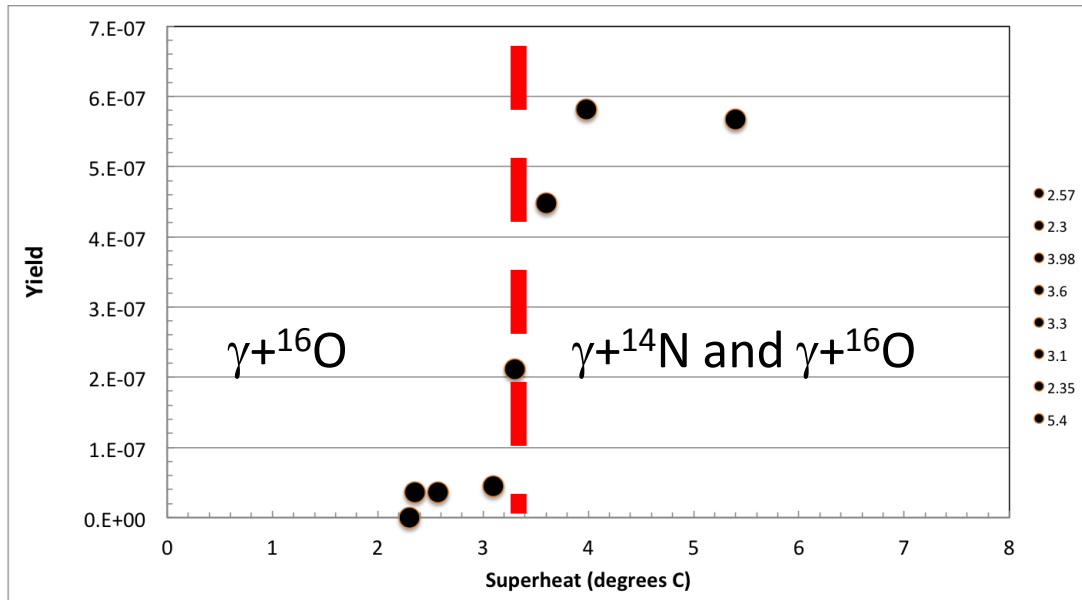
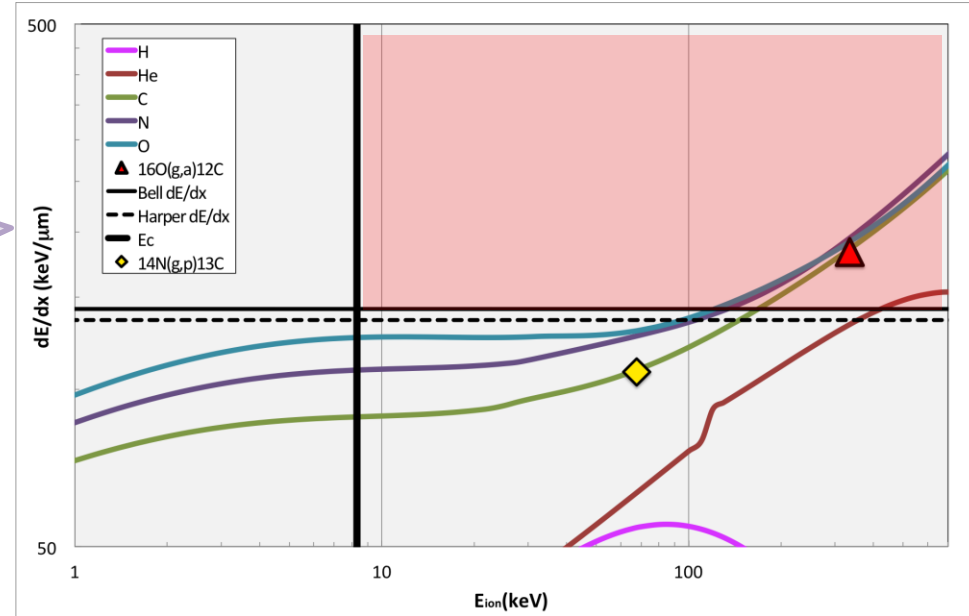

N_2O efficiency curve,
HIGS April 2013,
 $E_\gamma = 9.7$ MeV

EXPERIMENTAL SETUP AT JLAB INJECTOR

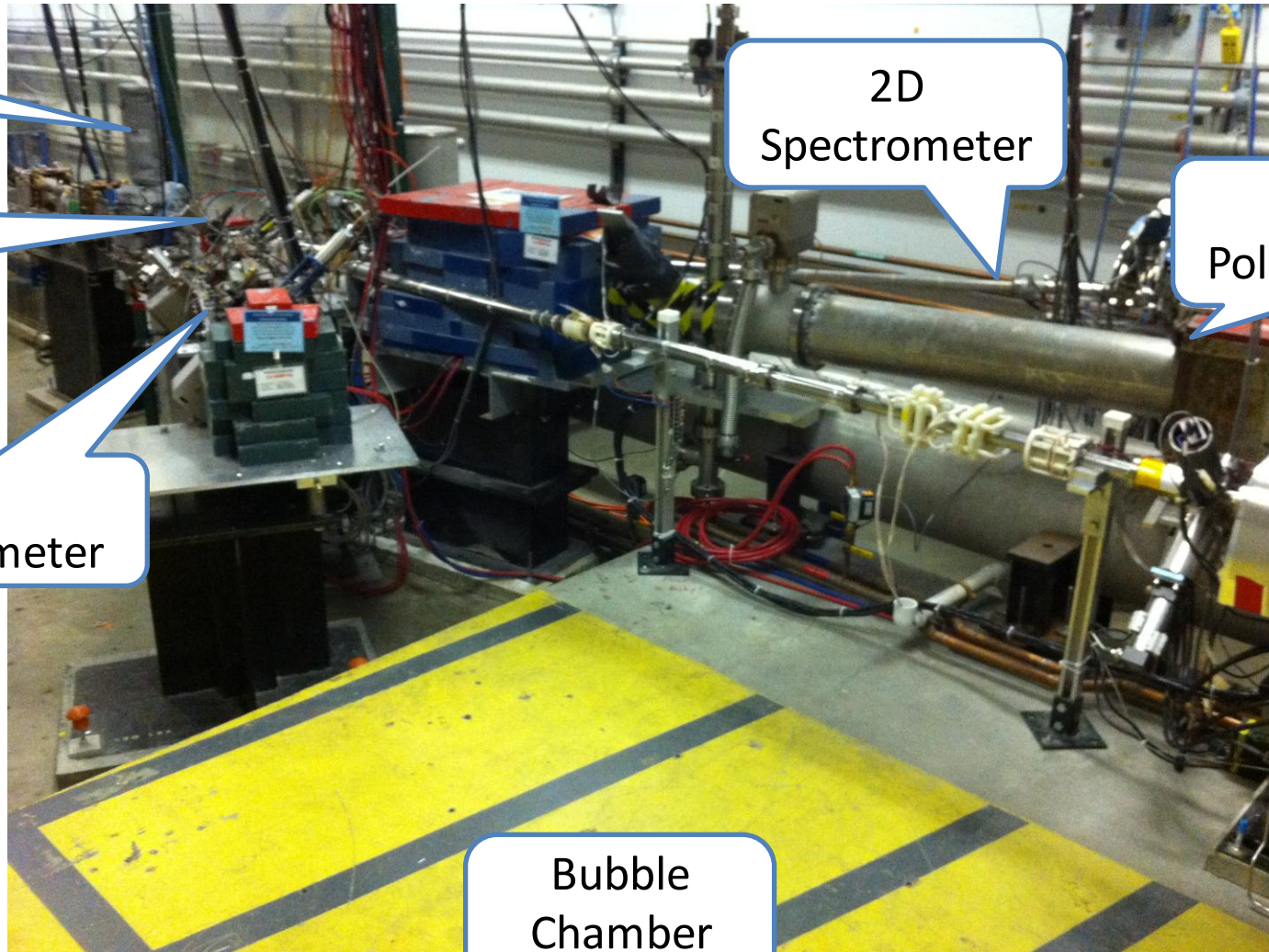

BCM

5 MeV
Dipole

5D
Spectrometer

2D
Spectrometer

Mott
Polarimeter

Bubble
Chamber
location

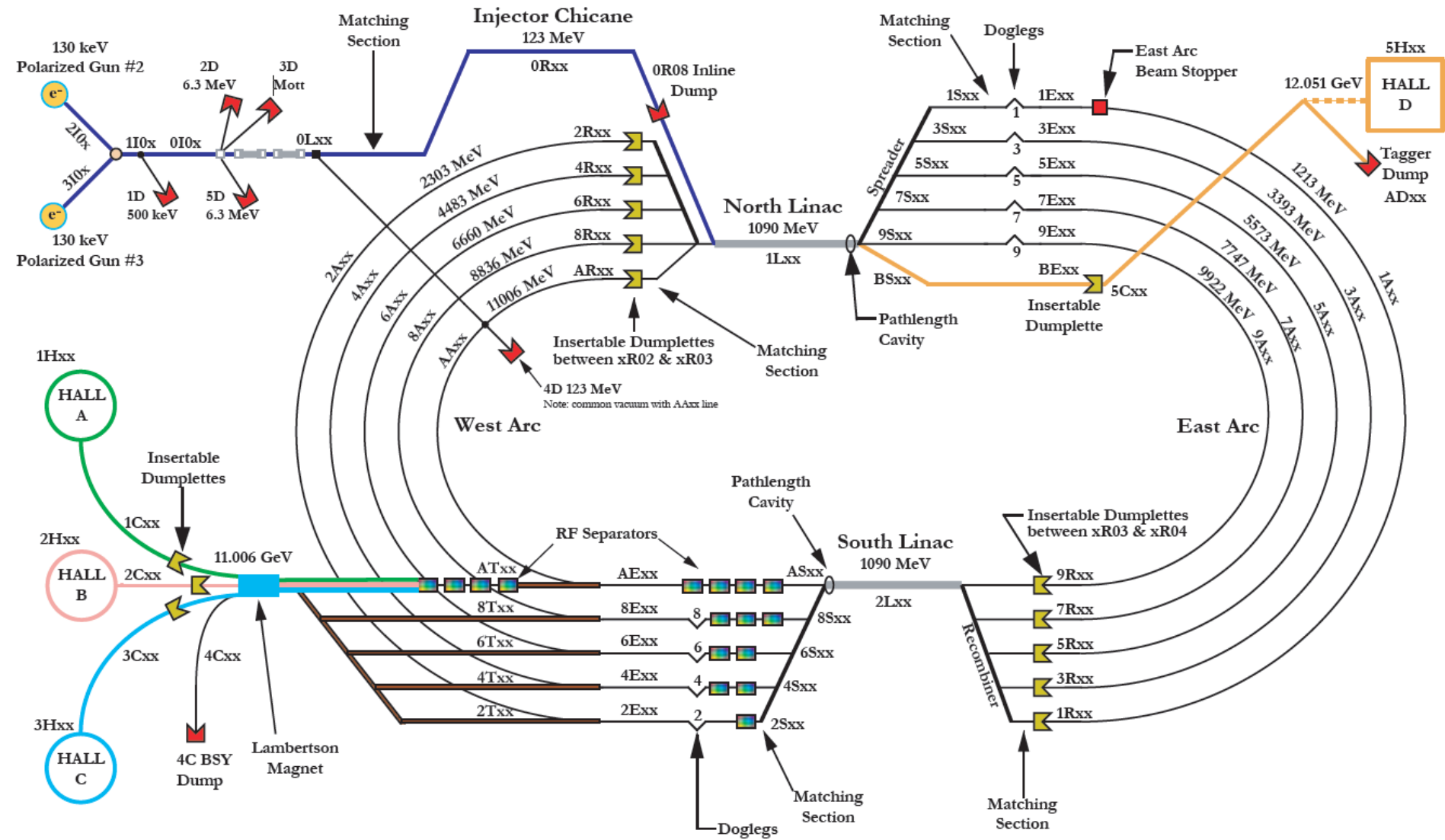

BEAMLINE

Bubble Chamber at
HIGS April 2013

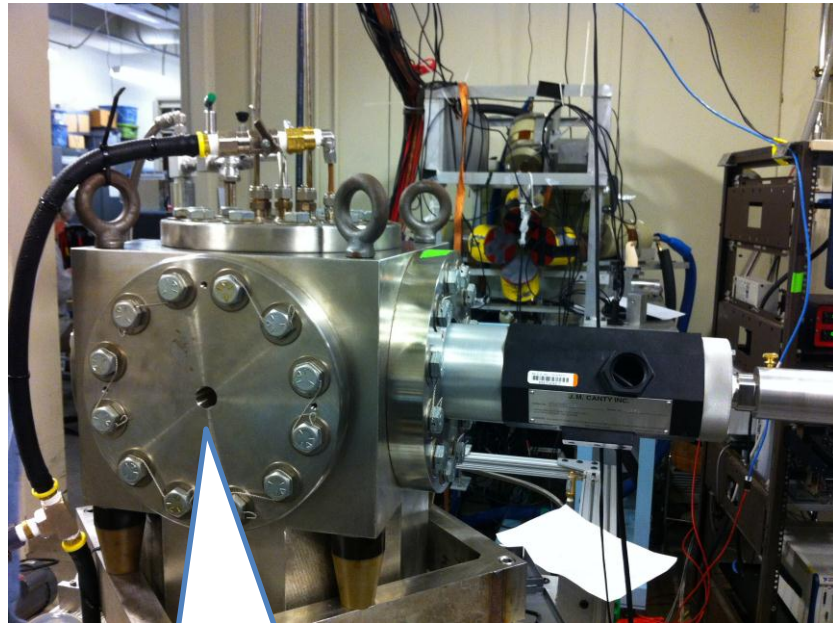
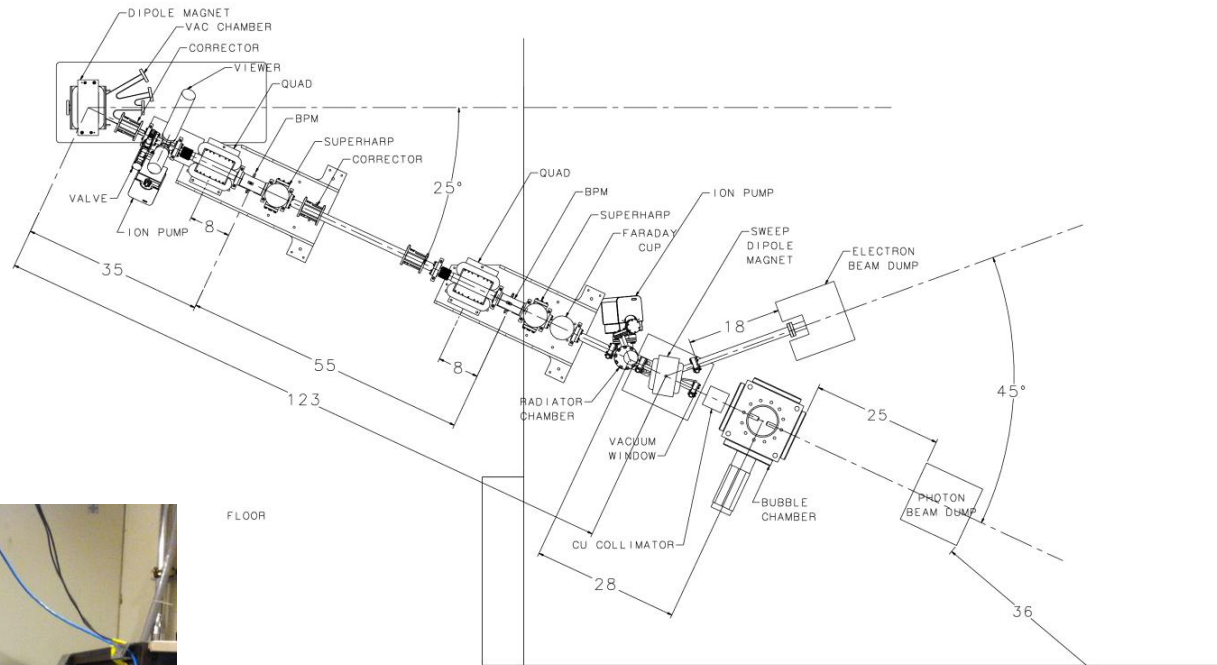

Photon Beam
Entrance

Beam Kinetic Energy, (MeV)	7.9–8.5
Beam Current (μA)	0.01–100
Absolute Beam Energy Uncertainty	<0.1%
Relative Beam Energy Uncertainty	<0.02%
Energy Resolution (Spread), σ_T/T	<0.06%
Beam Size, $\sigma_{x,y}$ (mm)	1–2

Electron Beam
Requirements at Radiator

SCHEMATICS

- Power deposited in radiator (100 μA and 8.5 MeV) :
 - I. 0.02 mm: Energy loss = 21 keV, $P = 2.1 \text{ W}$
- Pure Copper and Aluminum (high neutron threshold):
 - I. $^{63}\text{C}(\gamma, n)$ threshold = 10.86 MeV
 - II. $^{27}\text{Al}(\gamma, n)$ threshold = 13.06 MeV

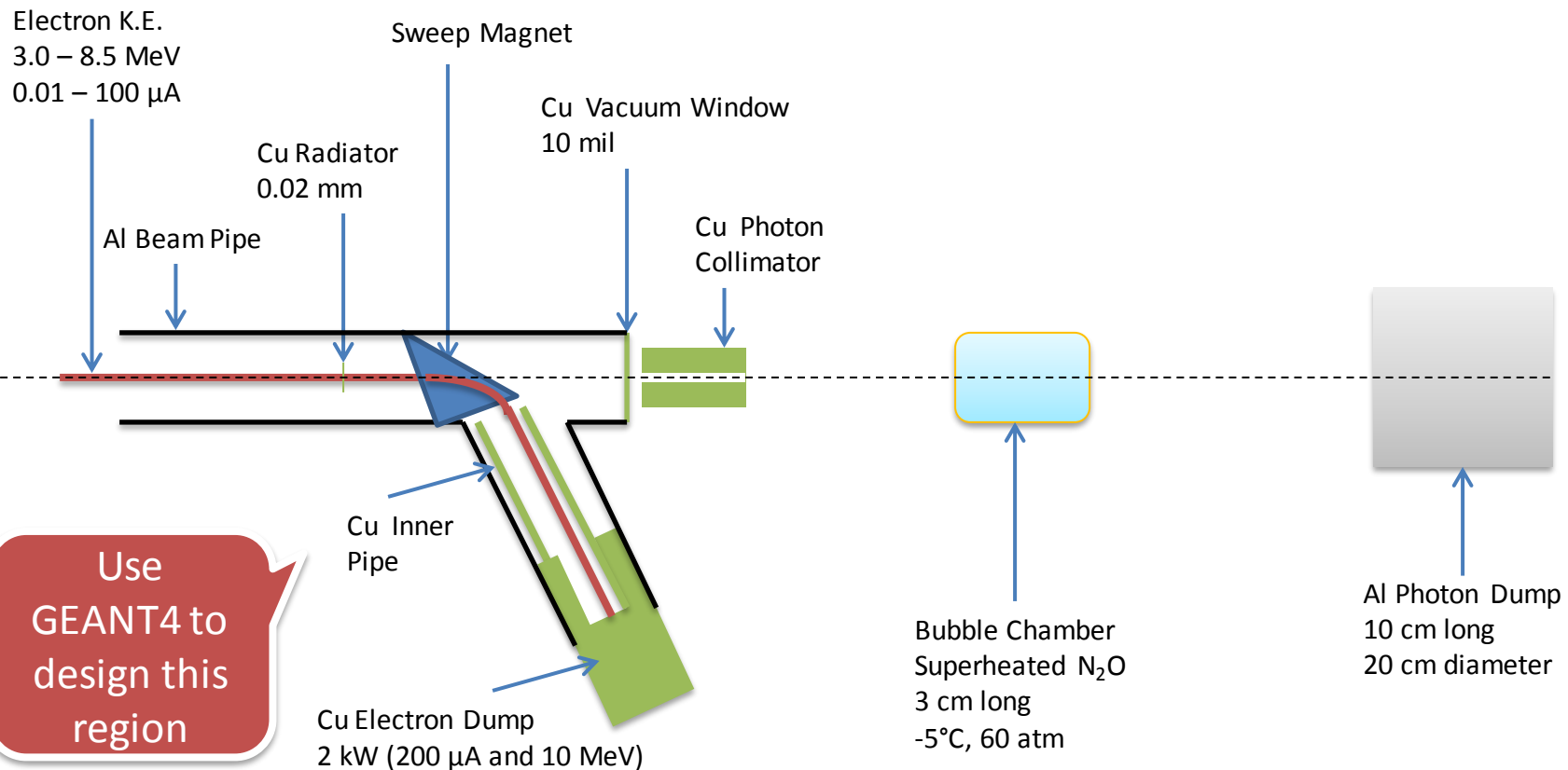

MEASURING ABSOLUTE BEAM ENERGY

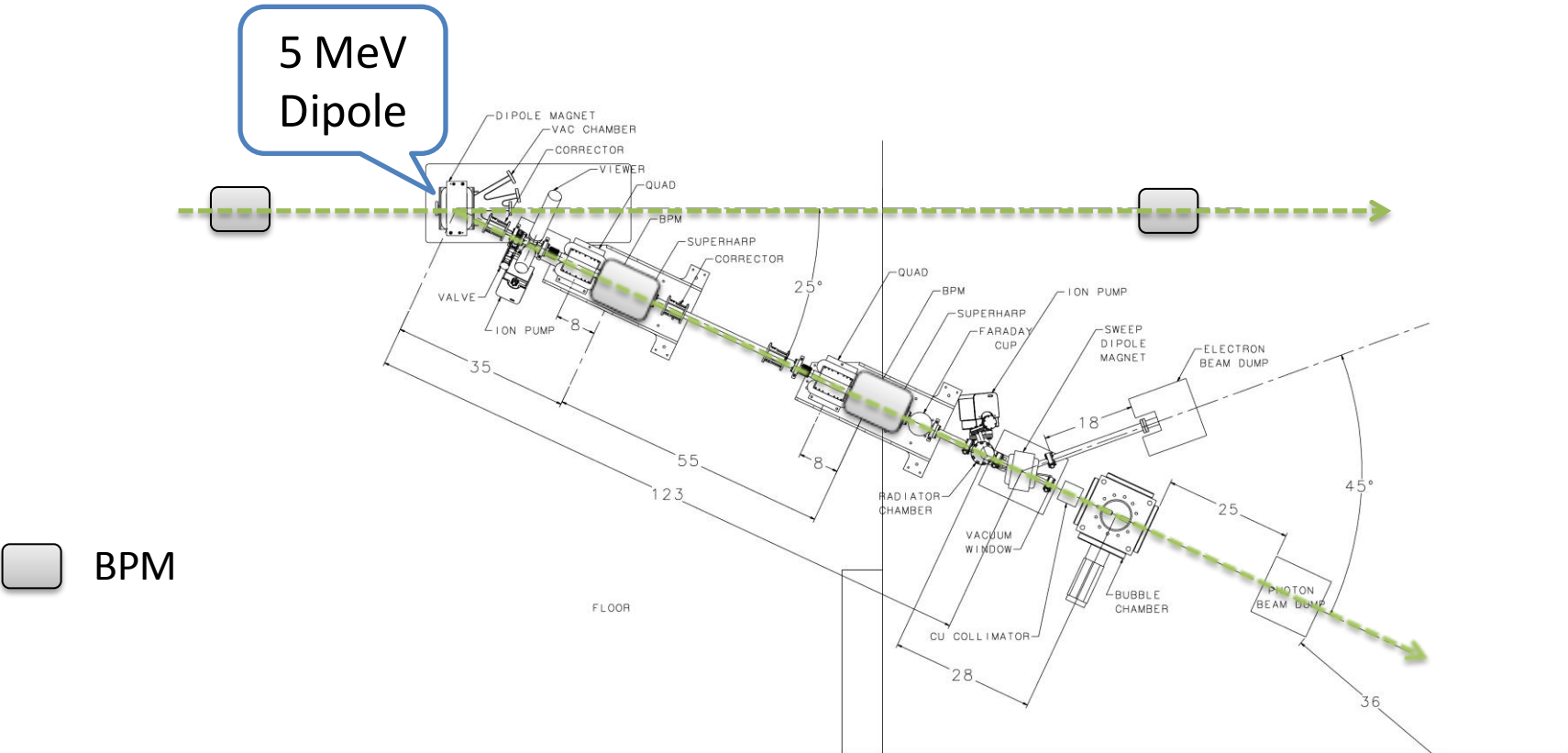

Electron Beam Momentum

$$p = \frac{\int Bdl}{\theta}$$

Parameter	Term	Now	Goal
Dipole – linearity	$\delta B/B$	0.25%	0.02%
Dipole – spatial	$\delta BL/BL$	0.10%	0.02%
Dipole – reproduce	$\delta B/B$	0.10%	0.02%
Dipole – power supply	$\delta I/I$	0.20%	0.02%
Position – surveys	$\delta \theta/\theta$	0.01%	0.01%
Position – BPM calibration	$\delta \theta/\theta$	0.05%	0.05%
Stray magnetic field	$\delta \theta/\theta$	0.05%	0.05%
Total	$\delta P/P$	0.36%	<0.10%

- I. Jay Benesch designed and is now working with Engineering to fabricate a more uniform and higher field dipole
- II. New Hall Probe: 0.01% accuracy, resolution to 2 ppm, and a temperature stability of 10 ppm/°C
- III. Better shielding of Earth's and other stray magnetic fields
- IV. Additional goal: Relative beam energy uncertainty **<0.02%**

BREMSSTRAHLUNG BEAM

- Use both GEANT4 and FLUKA to calculate Bremsstrahlung spectra (we will not measure Bremsstrahlung spectra)
- Monte Carlo simulation of Bremsstrahlung at radiotherapy energies is well studied, accuracy: $\pm 5\%$

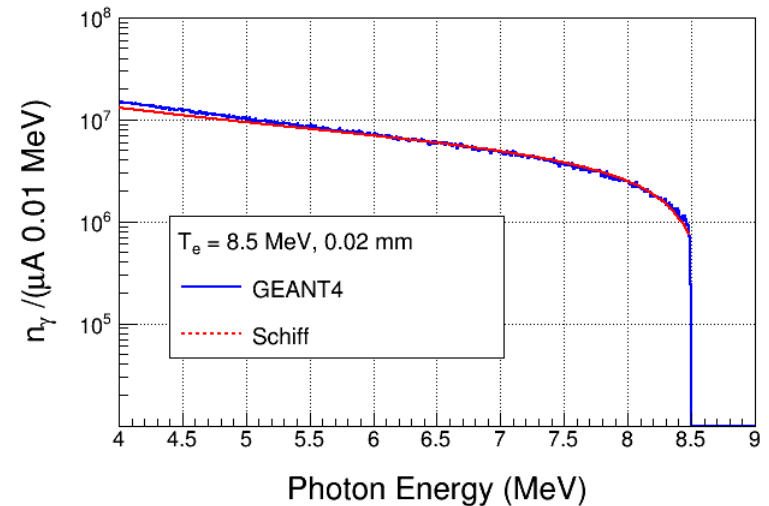

$^{16}\text{O}(\gamma, \alpha)^{12}\text{C}$ is ideal case for Bremsstrahlung beam and Penfold–Leiss Unfolding :

- Very steep; only photons near endpoint contribute to yield
- No-structure (resonances)

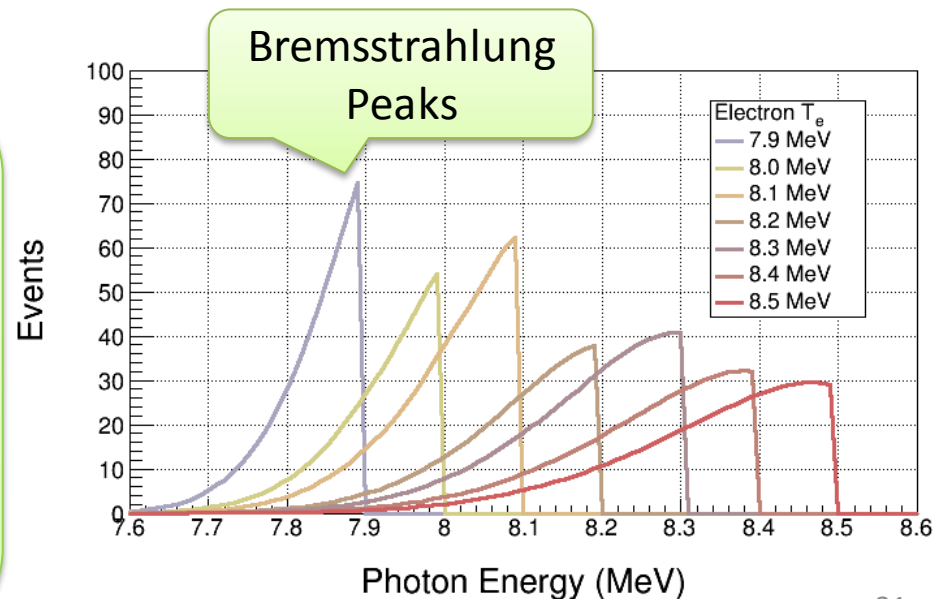

GEANT4 SIMULATION

- Both GEANT4 and FLUKA use models that calculate wrong photo-nuclear cross sections. Both do not allow for user's cross sections. What to do?
 - I. Use GEANT4 and FLUKA to produce the photon spectra impinging on the superheated liquid.
 - II. Fold the above photon spectra with our cross sections in stand-alone codes.
- Use GEANT4 to design radiator, collimator, and dumps
- Geometry in GEANT4:

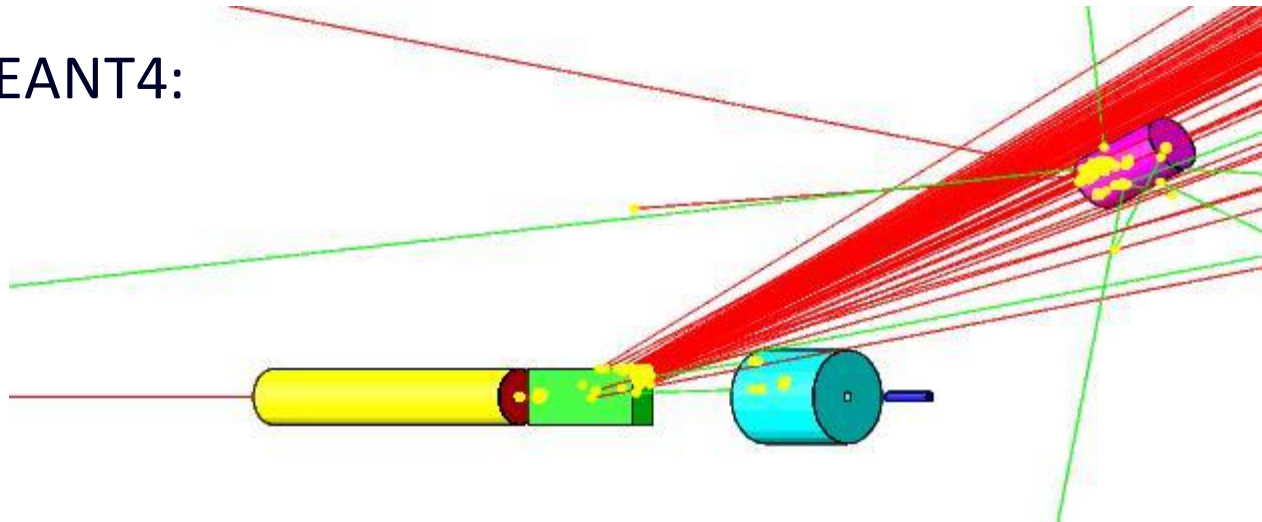

PENFOLD-LEISS CROSS SECTION UNFOLDING

- Measure yields at: $E = E_1, E_2, \dots, E_n$ where,
 $E_i - E_{i-1} = \Delta, i = 2, n$

$$Y(E_i) = \int_{th}^{E_i} n_\gamma(E_i, k) \sigma(k) dk \approx \sum_{j=1}^i N_\gamma(E_i, \Delta, E_j) \sigma(E_j)$$

Volterra Integral Equation of First Kind

Method of Quadratures:
 numerical solution of integral equation based on replacement of integral by finite sum

- The solution can be written in two forms:

$$\sigma_i = \frac{1}{N_{ii}} \left[y_i - \sum_{j=1}^{i-1} (N_{ij} \sigma_j) \right]$$

- Or, Matrix form:

$$\begin{bmatrix} y_1 \\ y_2 \\ \vdots \\ y_n \end{bmatrix} = \begin{bmatrix} N_{\gamma,11} & 0 & \cdots & 0 \\ N_{\gamma,21} & N_{\gamma,22} & \cdots & 0 \\ \vdots & \ddots & \ddots & 0 \\ N_{\gamma,n1} & N_{\gamma,n2} & \cdots & N_{\gamma,nn} \end{bmatrix} \begin{bmatrix} \sigma_1 \\ \sigma_2 \\ \vdots \\ \sigma_n \end{bmatrix}$$

$$[Y] = [N] \bullet [\sigma]$$

$$[\sigma] = [N]^{-1} \bullet [Y]$$

STATISTICAL ERROR PROPAGATION

- Note: $\frac{dy_i}{y_i} = \frac{1}{\sqrt{y_i}}$ $\frac{dN_{ij}}{N_{ij}} = \frac{1}{\sqrt{N_{ij}}} \approx 0$

$$dy_i = \sqrt{y_i} \qquad dy_i = \sqrt{y_i + 2y_i^{bg}}$$

In case of
background
Subtraction

- With:

$$[B] = [N]^{-1}$$

$$[\sigma] = [B] \bullet [Y]$$

- Then:

$$[d\sigma^2] = [B] \bullet [dY^2] \bullet [B]^T$$

- Where:

$$[dY^2] = \begin{bmatrix} y_1 & 0 & \cdots & 0 \\ 0 & y_2 & \cdots & 0 \\ \vdots & \ddots & \ddots & \vdots \\ 0 & 0 & \cdots & y_n \end{bmatrix}$$

$$\begin{aligned} \text{var}(y_i, y_i) &= y_i \\ \text{cov}(y_i, y_j) &= 0 \end{aligned}$$

$$[d\sigma^2] = \begin{bmatrix} d\sigma_1^2 & \text{cov}(\sigma_1, \sigma_2) & \cdots & \text{cov}(\sigma_1, \sigma_n) \\ \text{cov}(\sigma_2, \sigma_1) & d\sigma_2^2 & \cdots & \text{cov}(\sigma_2, \sigma_n) \\ \vdots & \ddots & \ddots & \vdots \\ \text{cov}(\sigma_n, \sigma_1) & \text{cov}(\sigma_n, \sigma_2) & \cdots & d\sigma_n^2 \end{bmatrix}$$

Although,

$$\begin{aligned} \text{cov}(y_i, y_j) &= 0, \\ \text{cov}(\sigma_i, \sigma_j) &\neq 0 \end{aligned}$$

$$(d\sigma_i)^2 = \frac{1}{N_{ii}^2} \left[dy_i^2 + \sum_{j=1}^{i-1} (N_{ij} d\sigma_j)^2 + \sum_{k=1}^{i-1} \sum_{l=1}^{i-1} N_{ik} \text{cov}(\sigma_k, \sigma_l) N_{il} \right]$$

For mono-chromatic
photon beam

$$\left(\frac{d\sigma_i}{\sigma_i} \right)^2 = \left(\frac{dy_i}{y_i} \right)^2 = \frac{1}{y_i}$$

RESULTS

- I. Radiator thickness = 0.02 mm
- II. Bubble Chamber thickness = 3.0 cm, number of ^{16}O nuclei = $3.474 \cdot 10^{22} / \text{cm}^2$
- III. Background subtraction of $^{18}\text{O}(\gamma, \alpha)^{14}\text{C}$

$$[N] = \begin{bmatrix} 3.267e14 & 0 & 0 & 0 & 0 & 0 & 0 \\ 9.782e13 & 6.439e13 & 0 & 0 & 0 & 0 & 0 \\ 5.013e13 & 3.858e13 & 2.539e13 & 0 & 0 & 0 & 0 \\ 1.494e13 & 1.236e13 & 9.514e12 & 6.258e12 & 0 & 0 & 0 \\ 8.540e12 & 7.369e12 & 6.097e12 & 4.692e12 & 3.086e12 & 0 & 0 \\ 3.801e12 & 3.370e12 & 2.908e12 & 2.406e12 & 1.852e12 & 1.217e12 & 0 \\ 2.075e12 & 1.875e12 & 1.663e12 & 1.435e12 & 1.187e12 & 9.137e11 & 6.004e11 \end{bmatrix}$$

Electron Beam K. E.	Beam Current (μA)	Time (hour)	y_i	dy_i (no bg)	dy_i/y_i (no bg, %)	dy_i (with bg)	dy_i/y_i (with bg, %)
7.9	100	100	545	23	4.2	134	24.6
8.0	100	20	581	24	4.1	77	13.3
8.1	80	10	852	29	3.4	60	7.0
8.2	20	10	634	25	3.9	40	6.3
8.3	10	10	812	28	3.4	39	4.8
8.4	4	10	746	27	3.6	36	4.8
8.5	2	10	763	28	3.7	32	4.2

SYSTEMATIC ERROR PROPAGATION

- For absolute beam energy uncertainty of δE ($= 0.1\%$) and zero relative beam energy uncertainty:

$$\frac{dy_i}{y_i} = \frac{y_i(E_i + \delta E) - y_i(E_i)}{y_i(E_i)}$$

$$\frac{dN_{ij}}{N_{ij}} = \frac{N_{ij}(E_i + \delta E) - N_{ij}(E_i)}{N_{ij}(E_i)}$$

$$E_0 = 7.8 + \delta E$$

$$E_i = E_0 + i\Delta$$

E_i (MeV)	dy_i/y_i (%)	$d\sigma_i/\sigma_i$ (%)
7.9	12.5	12.6
8.0	10.8	10.5
8.1	9.3	9.1
8.2	8.0	7.1
8.3	7.0	6.3
8.4	6.3	5.8
8.5	5.6	5.2

This is the cross section dependence on energy

- Accounted for dN_{ij} due to energy error when calculating dy_i

$$\approx \frac{\delta E}{i\Delta}$$

$$\left[\frac{dN_{ij}}{N_{ij}} \right] = \begin{bmatrix} 0.100 & 0 & 0 & 0 & 0 & 0 & 0 \\ 0.058 & 0.050 & 0 & 0 & 0 & 0 & 0 \\ 0.041 & 0.039 & 0.033 & 0 & 0 & 0 & 0 \\ 0.031 & 0.031 & 0.029 & 0.025 & 0 & 0 & 0 \\ 0.025 & 0.025 & 0.025 & 0.023 & 0.020 & 0 & 0 \\ 0.021 & 0.021 & 0.021 & 0.021 & 0.020 & 0.017 & 0 \\ 0.018 & 0.018 & 0.018 & 0.018 & 0.018 & 0.017 & 0.022 \end{bmatrix}$$

- With:

$$[B] = [N]^{-1}$$

$$[\sigma] = [B] \bullet [Y]$$

- Then:

$$[d\sigma^2] = [B] \bullet \left([dY^2] + [dN^2] \bullet [\sigma^2] \right) \bullet [B]^T$$

- Where:

Note: Correlation Coefficient (ρ_{ij}) = 1

$$\text{var}(y_i, y_i) = (dy_i)^2$$

$$\text{cov}(y_i, y_j) = \rho_{ij} dy_i dy_j$$

$$[dY^2] = \begin{bmatrix} (dy_1)^2 & dy_1 dy_2 & \cdots & dy_1 dy_n \\ dy_2 dy_1 & (dy_2)^2 & \cdots & dy_n dy_n \\ \vdots & \ddots & \ddots & \vdots \\ dy_n dy_1 & dy_n dy_2 & \cdots & (dy_n)^2 \end{bmatrix}$$

No energy-to-energy change in systematic error

$$[d\sigma^2] = \begin{bmatrix} d\sigma_1^2 & \text{cov}(\sigma_1, \sigma_2) & \cdots & \text{cov}(\sigma_1, \sigma_n) \\ \text{cov}(\sigma_2, \sigma_1) & d\sigma_2^2 & \cdots & \text{cov}(\sigma_2, \sigma_n) \\ \vdots & \ddots & \ddots & \vdots \\ \text{cov}(\sigma_n, \sigma_1) & \text{cov}(\sigma_n, \sigma_2) & \cdots & d\sigma_n^2 \end{bmatrix}$$

$$[dN^2] = \begin{bmatrix} (dN_{11})^2 & 0 & \cdots & 0 \\ (dN_{21})^2 & (dN_{22})^2 & \cdots & 0 \\ \vdots & \ddots & \ddots & \vdots \\ (dN_{n1})^2 & (dN_{n2})^2 & \cdots & (dN_{nn})^2 \end{bmatrix}$$

$$[\sigma^2] = \begin{bmatrix} \sigma_1^2 & 0 & \cdots & 0 \\ 0 & \sigma_2^2 & \cdots & 0 \\ \vdots & \ddots & \ddots & \vdots \\ 0 & 0 & \cdots & \sigma_n^2 \end{bmatrix}$$

SYSTEMATIC ERROR PROPAGATION

No energy-to-energy change in systematic error

$$\begin{aligned}
 (d\sigma_i)^2 \cong & \frac{1}{N_{ii}^2} \left[dy_i^2 - 2dy_i \sum_{j=1}^{i-1} N_{ij} d\sigma_j \right. \\
 & + \sum_{j=1}^{i-1} (N_{ij} d\sigma_j)^2 + \sum_{k=1}^{i-1} \sum_{l=1}^{i-1} N_{ik} \text{cov}(\sigma_k, \sigma_l) N_{il} \\
 & \left. + \sum_{j=1}^{i-1} (dN_{ij} \sigma_j)^2 + (dN_{ii} \sigma_i)^2 \right]
 \end{aligned}$$

$\text{cov}(y_i, y_j) \neq 0,$
 $\text{cov}(\sigma_i, \sigma_j) \neq 0$

OTHER SYSTEMATIC ERRORS

Beam Current, $\delta I/I$	3%
Photon Flux, $\delta\phi/\phi$	5%
Radiator Thickness, $\delta R/R$	3%
Bubble Chamber Thickness, $\delta T/T$	3%
Bubble Chamber Efficiency, ε	5%

Simulation

- Then:

$$(dy_i)^2 = (dy_i(\delta E))^2 + \left[\left(\frac{\delta I}{I} \right)^2 + \left(\frac{\delta R}{R} \right)^2 + \left(\frac{\delta T}{T} \right)^2 + \varepsilon^2 \right] y_i^2$$

$$(dN_{ij})^2 = \left(\frac{\delta\phi}{\phi} \right)^2 N_{ij}^2$$

Electron Beam K. E.	Cross Section (nb)	Stat Error (no bg, %)	Stat Error (with bg, %)
7.9	0.046	4.4	24.5
8.0	0.185	6.0	20.7
8.1	0.58	6.3	14.7
8.2	1.53	8.2	13.8
8.3	3.49	9.1	13.3
8.4	7.2	10.6	13.8
8.5	13.6	12.2	14.8

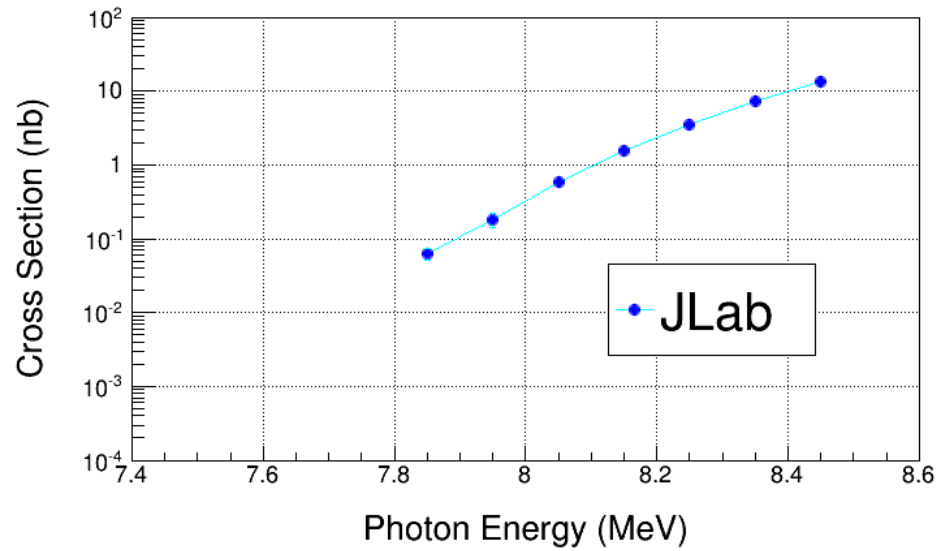

Electron Beam K. E.	Cross Section (nb)	Sys Error (Energy, %)	Sys Error (Total, %)
7.9	0.046	12.5	15.3
8.0	0.185	10.2	13.5
8.1	0.58	8.3	12.2
8.2	1.53	7.0	11.4
8.3	3.49	6.0	10.7
8.4	7.2	5.3	10.5
8.5	13.6	4.7	10.1

Note: Absolute systematic errors do not get magnified in PL Unfolding

JLAB PROJECTED $^{12}\text{C}(\alpha,\gamma)^{16}\text{O}$ S-Factor

- Statistical Error: dominated by background subtraction from $^{18}\text{O}(\gamma,\alpha)^{14}\text{C}$ (depletion = 5,000)

Electron Beam K. E.	Gamma Energy (MeV)	E_{CM} (MeV)	Cross Section (nb)	S_{tot} Factor (keV b)	Stat Error (%)	Sys Error (Total, %)
7.9	7.85	0.69	0.046	62.2	24.5	15.3
8.0	7.95	0.79	0.185	48.7	20.7	13.5
8.1	8.05	0.89	0.58	41.8	14.7	12.2
8.2	8.15	0.99	1.53	35.5	13.8	11.4
8.3	8.25	1.09	3.49	32.0	13.3	10.7
8.4	8.35	1.19	7.2	28.8	13.8	10.5
8.5	8.45	1.29	13.6	26.3	14.8	10.1

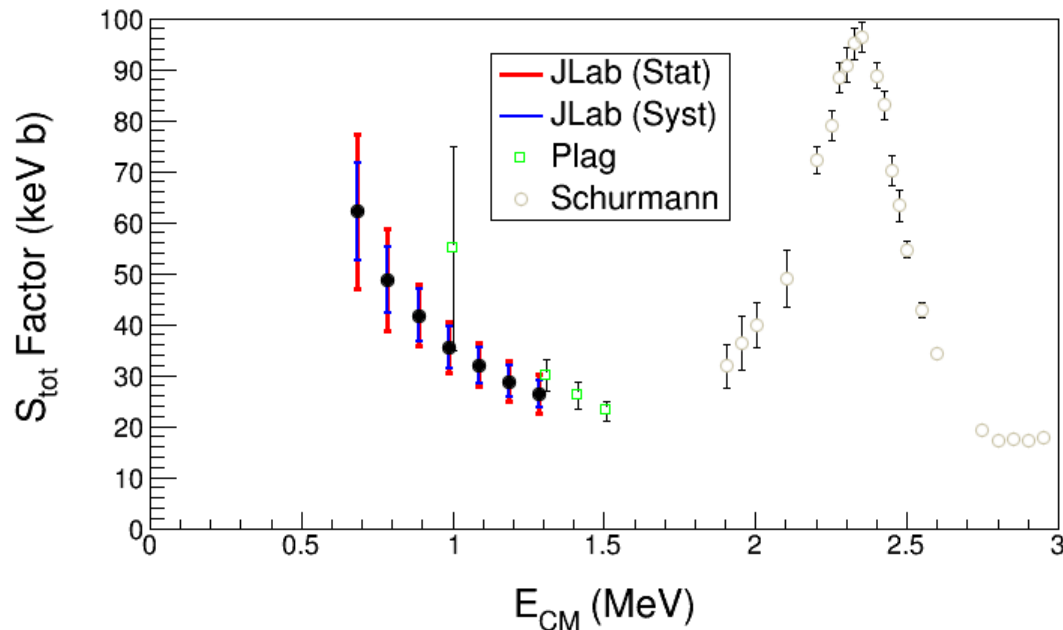

Bubble Chamber experiment measures total S-Factor, $S_{E1} + S_{E2}$

BACKGROUNDS

I. Background from oxygen isotopes and nitrogen in N₂O:

- $^{18}\text{O}(\gamma, \alpha)^{14}\text{C}$
- $^{17}\text{O}(\gamma, \alpha)^{13}\text{C}$
- $^{14}\text{N}(\gamma, p)^{13}\text{C}$

➤ Natural Abundance:

- I. ^{17}O : 0.038%
- II. ^{18}O : 0.205%

➤ Expected Rates:

- I. $^{17}\text{O}(\gamma, \alpha)^{13}\text{C}$, depletion=5,000
- II. $^{18}\text{O}(\gamma, \alpha)^{14}\text{C}$, depletion=5,000
- III. $^{14}\text{N}(\gamma, p)^{13}\text{C}$, Chamber eff.= 10^{-8}

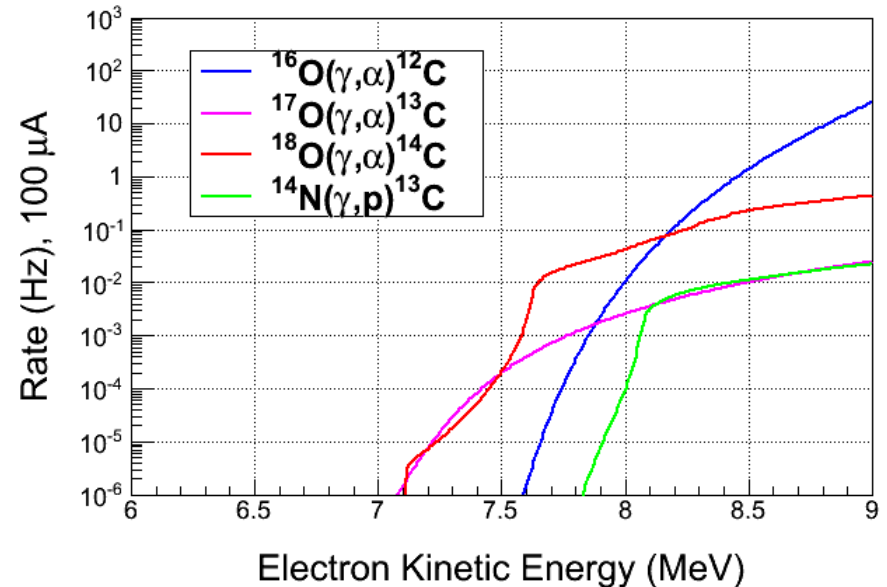
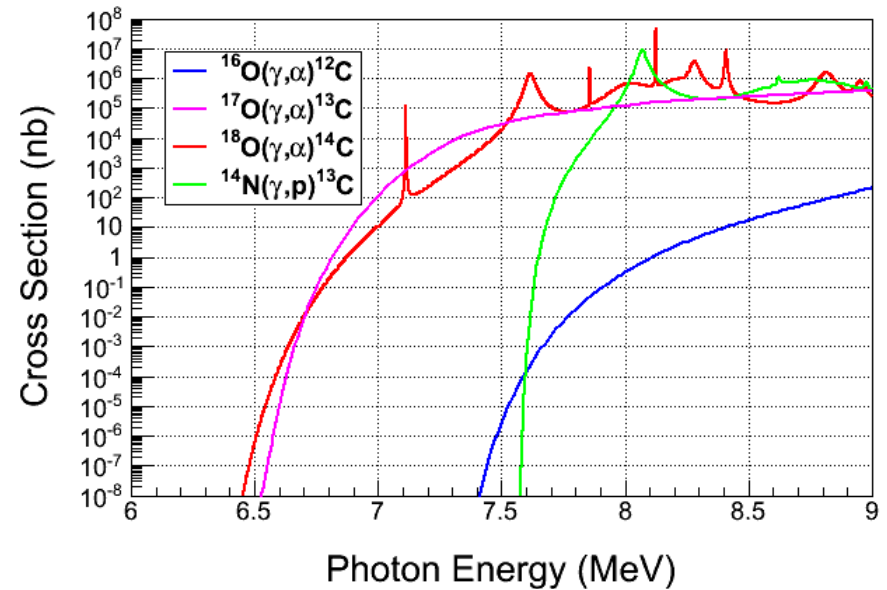

- II. Background from:
- $^{17}\text{O}(\gamma,n)^{16}\text{O}$ and secondary (n,n) neutron-nucleus elastic scattering

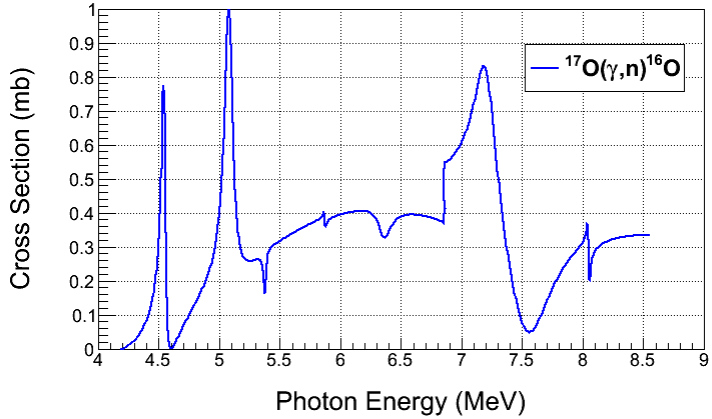

- III. Background from Chamber glass:
- Neutron-nucleus elastic scattering from $^{29}\text{Si}(\gamma,n)^{28}\text{Si}$

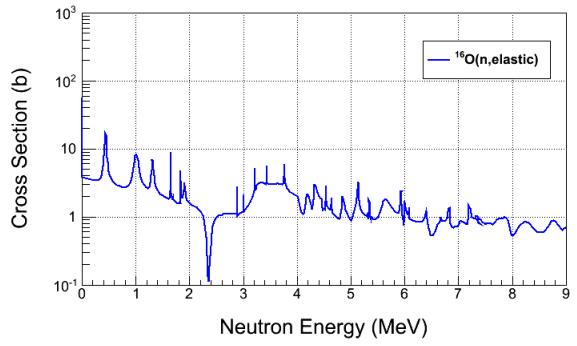

- IV. Cosmic-ray background:
- μ^\pm -nuclear
 - neutron-nuclear elastic scattering

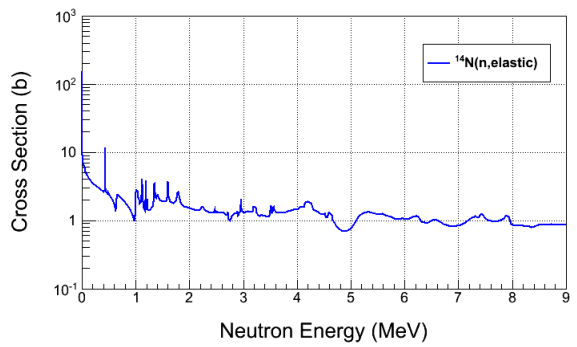

➤ Reject neutron events using acoustic signal (100 suppression factor)

ION ENERGY DISTRIBUTIONS

- Use depleted N₂O:
 - I. ¹⁷O depletion = 5,000
 - II. ¹⁸O depletion = 5,000
- Suppress background with Bubble Chamber thresholds

$$E_{CM} \cong E_{\gamma} - Q$$

$$E_{CM} = T_{\alpha} + T_C$$

$$T_{\alpha,lab} \cong \frac{m_c}{m_{\alpha} + m_c} E_{CM}$$

$$T_{C,lab} \cong \frac{m_{\alpha}}{m_{\alpha} + m_c} E_{CM}$$

- Threshold Efficiency (function of superheat):

Particle	Efficiency
e [±]	<10 ⁻¹¹
γ	<10 ⁻¹¹
¹⁴ N(γ,p) ¹³ C	<10 ⁻⁸

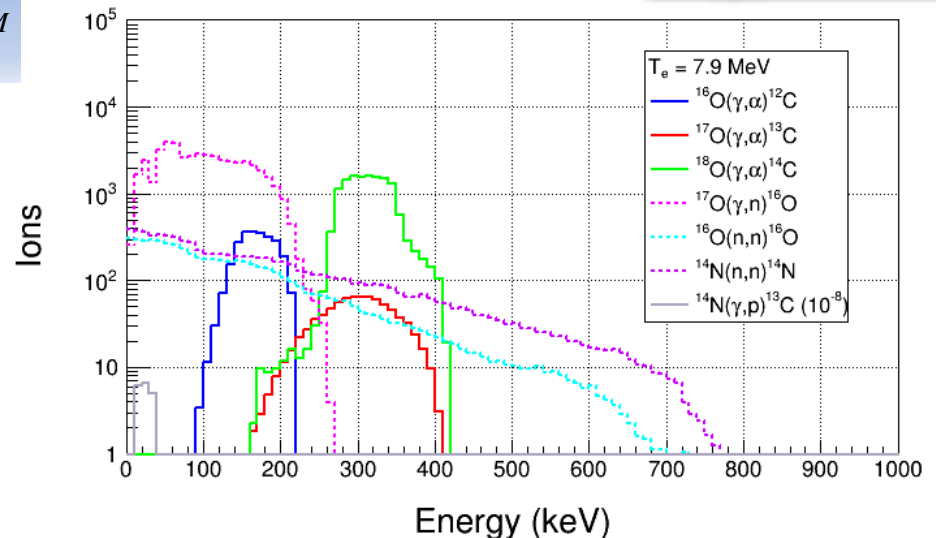
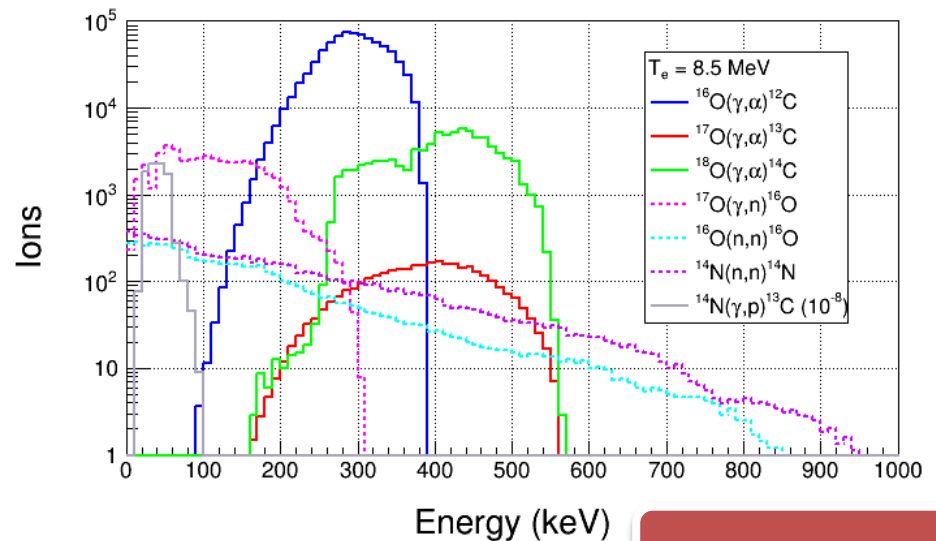

SUPERHEATED TARGETS

I. List of superheated liquids to be used in experiment:

	N₂O Targets	¹⁶O	¹⁷O	¹⁸O
	Natural Target	99.757%	0.038%	0.205%
Physics	¹⁶ O Target		Depleted > 5,000	Depleted > 5,000
	¹⁷ O Target		Enriched > 80%	<1.0%
Measure Backgrounds	¹⁸ O Target		<1.0%	Enriched > 80%

II. Readout:

- I. Fast Digital Camera
- II. Acoustic Signal to discriminate between neutron and alpha events

SUMMARY AND OUTLOOK

- Test N₂O Bubble Chamber at HIGS (Summer 2014)
- Measure cross sections of $^{18}\text{O}(\gamma, \alpha)^{14}\text{C}$ and $^{17}\text{O}(\gamma, \alpha)^{13}\text{C}$ at HIGS (Fall 2014)
- Test Bubble Chamber at JLab (October 2014, January 2015)
- Run depleted N₂O bubble chamber at JLab to measure $^{16}\text{O}(\gamma, \alpha)^{12}\text{C}$
- Beam issues:
 - Design radiator, collimator, and dumps with GEANT4
 - Simulate photon spectra with GEANT4 and FLUKA
 - Deliver 8.5 MeV K.E. beam to 5D Spectrometer with <0.1% absolute energy uncertainty
- Bubble Chamber issues:
 - Study acoustic signal and measure neutron events suppression factor
 - Deadtime measurements: use laser shutter to stop beam while chamber is not ready
 - Measure O-isotopes depletion
- Background tests:
 - Measure cosmic-ray background
 - Study chamber thresholds efficiency vs. superheat and measure γ -rays suppression factor

BACKUP SLIDES

CO₂ SUPERHEATED LIQUID?

- Similar Bubble Chamber operational parameters as N₂O
- Natural Abundance: ¹³C: 1.07%
- Depletion: ¹³C depletion=1,000
- ¹³C(γ,n)¹²C Background

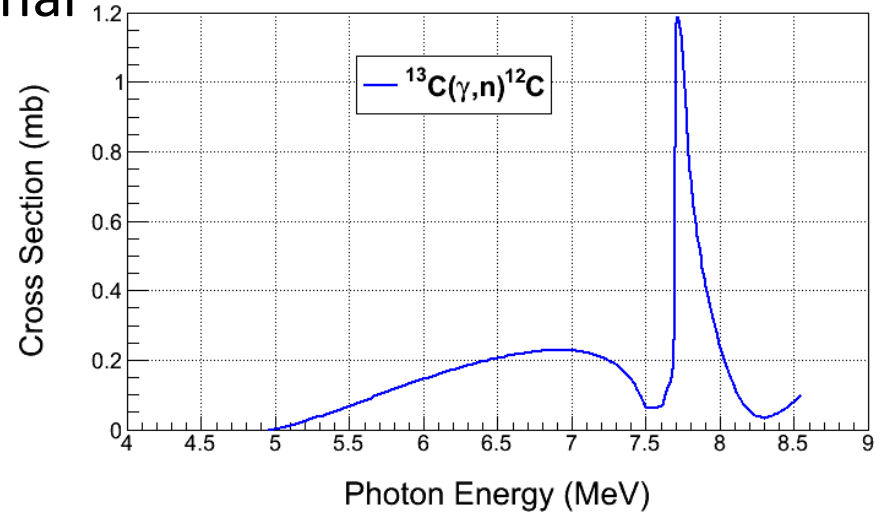

For comparison, ¹⁷O(γ,n)¹⁶O

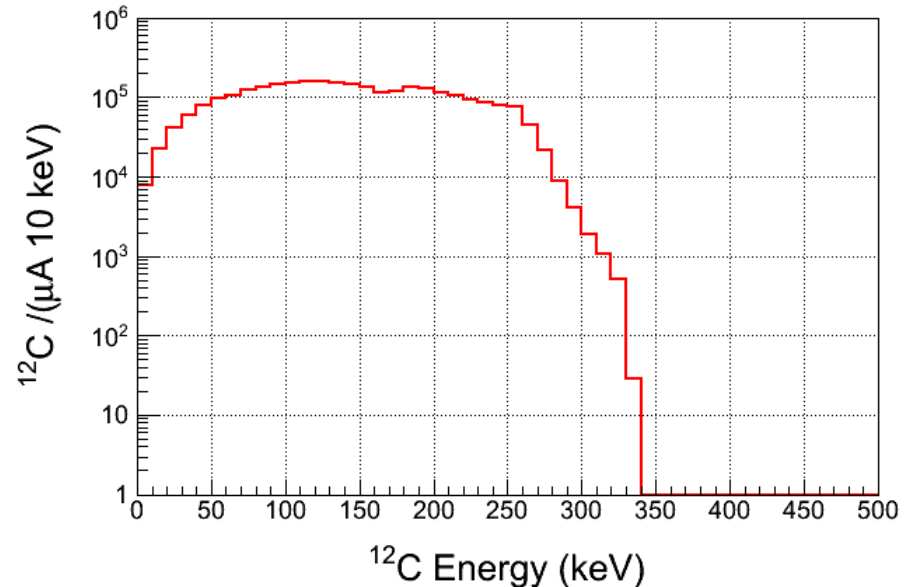
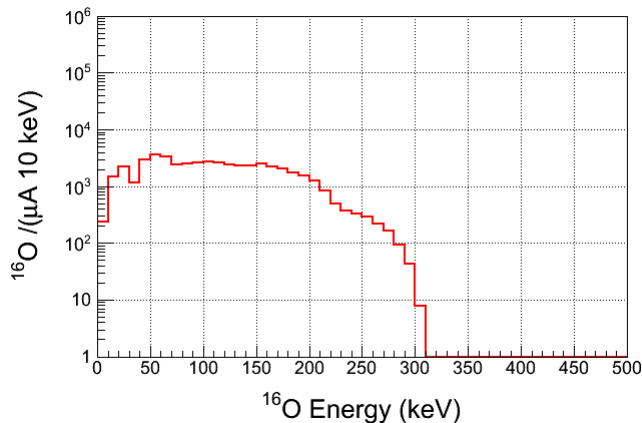

- ¹²C(γ,2α)α Background

WATER SUPERHEATED LIQUID?

- Etching of glass vessel by superheated H₂O
 - T = 250°C
 - P = 75 atm
- Background from secondary neutron–nucleus elastic scattering by neutrons from $d(\gamma,n)p$

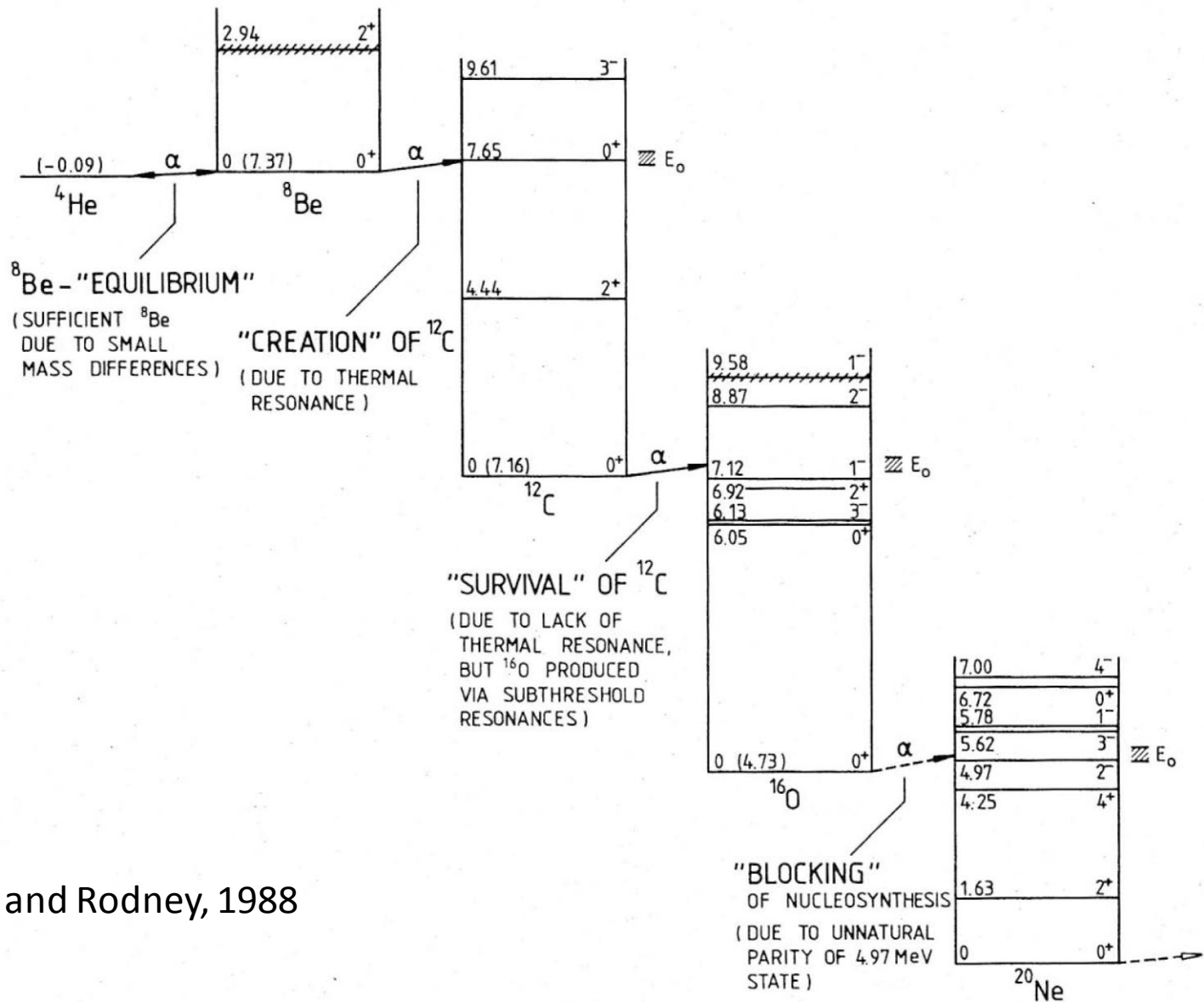

Rolfs and Rodney, 1988