

Measurement of  $^{16}\text{O}(\gamma, \alpha)^{12}\text{C}$  with Bubble Chamber and Bremsstrahlung Beam at Jefferson Lab Injector

Riad Suleiman

June 04, 2014



B. DiGiovine  
D. Henderson  
R. J. Holt  
K. E. Rehm



A. Robinson  
C. Ugalde



A. Sonnenschein



J. Benesch	M. Poelker
P. Degtiarenko	Y. Roblin
A. Freyberger	R. Suleiman
J. Grames	C. Tennant
G. Kharashvili	V. Vylet
D. Meekins	



W. Deconinck  
D. Getts

[https://wiki.jlab.org/ciswiki/index.php/Bubble Chamber](https://wiki.jlab.org/ciswiki/index.php/Bubble_Chamber)

# OUTLINE

- Nucleosynthesis and the  $^{12}\text{C}(\alpha,\gamma)^{16}\text{O}$  Reaction
- Time Reversal Reaction:  $^{16}\text{O}(\gamma,\alpha)^{12}\text{C}$
- The Bubble Chamber
- Bubble Chamber at HIGS
- Experimental Setup at Jefferson Lab Injector
- Bremsstrahlung Beam and Penfold-Leiss Unfolding
- Statistical and Systematic Errors
- Backgrounds and Ion Energy Distributions
- Summary and Outlook

# RELATIVE ABUNDANCE OF ELEMENTS BY WEIGHT

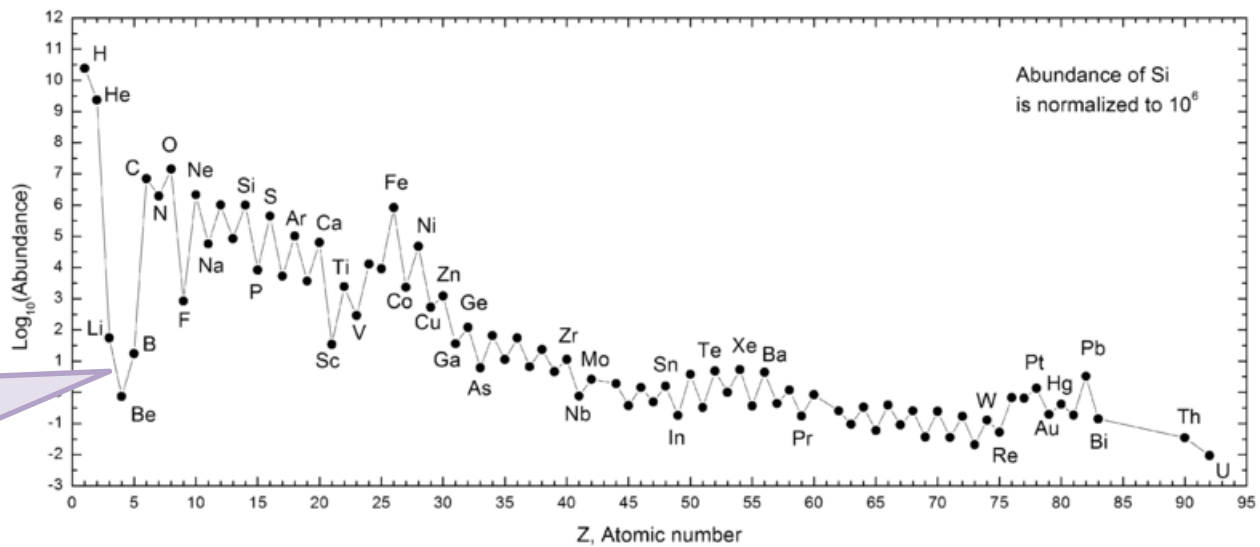
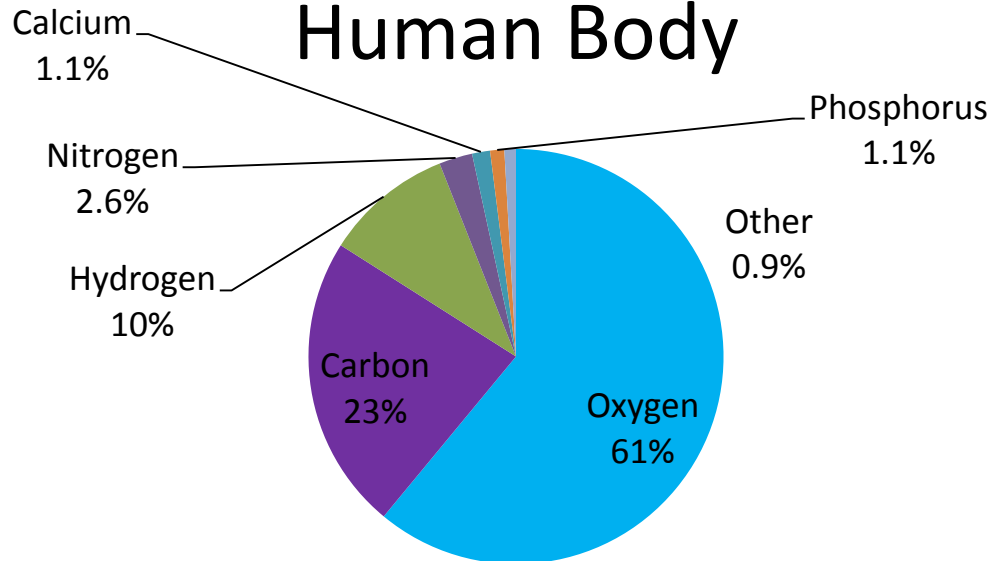
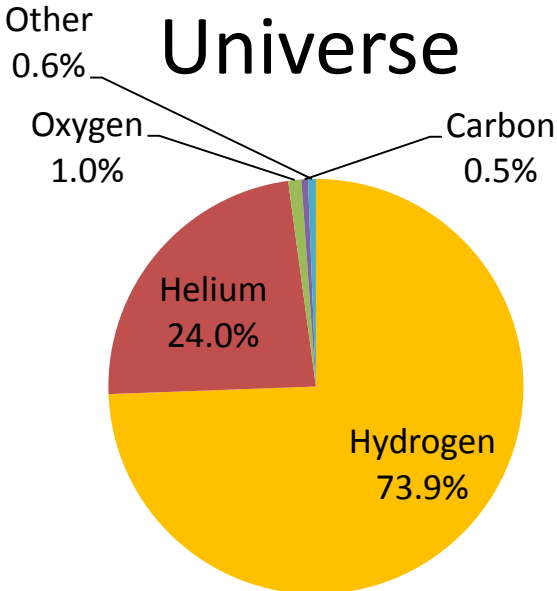

This region is bypassed by  $3\alpha$  process

# NUCLEOSYNTHESIS

- Big Bang Nucleosynthesis: quark–gluon plasma → p, n, He
- Stellar Nucleosynthesis: H burning, He burning, NCO cycle
- Supernovae Nucleosynthesis: Si burning
- Cosmic Ray Spallation

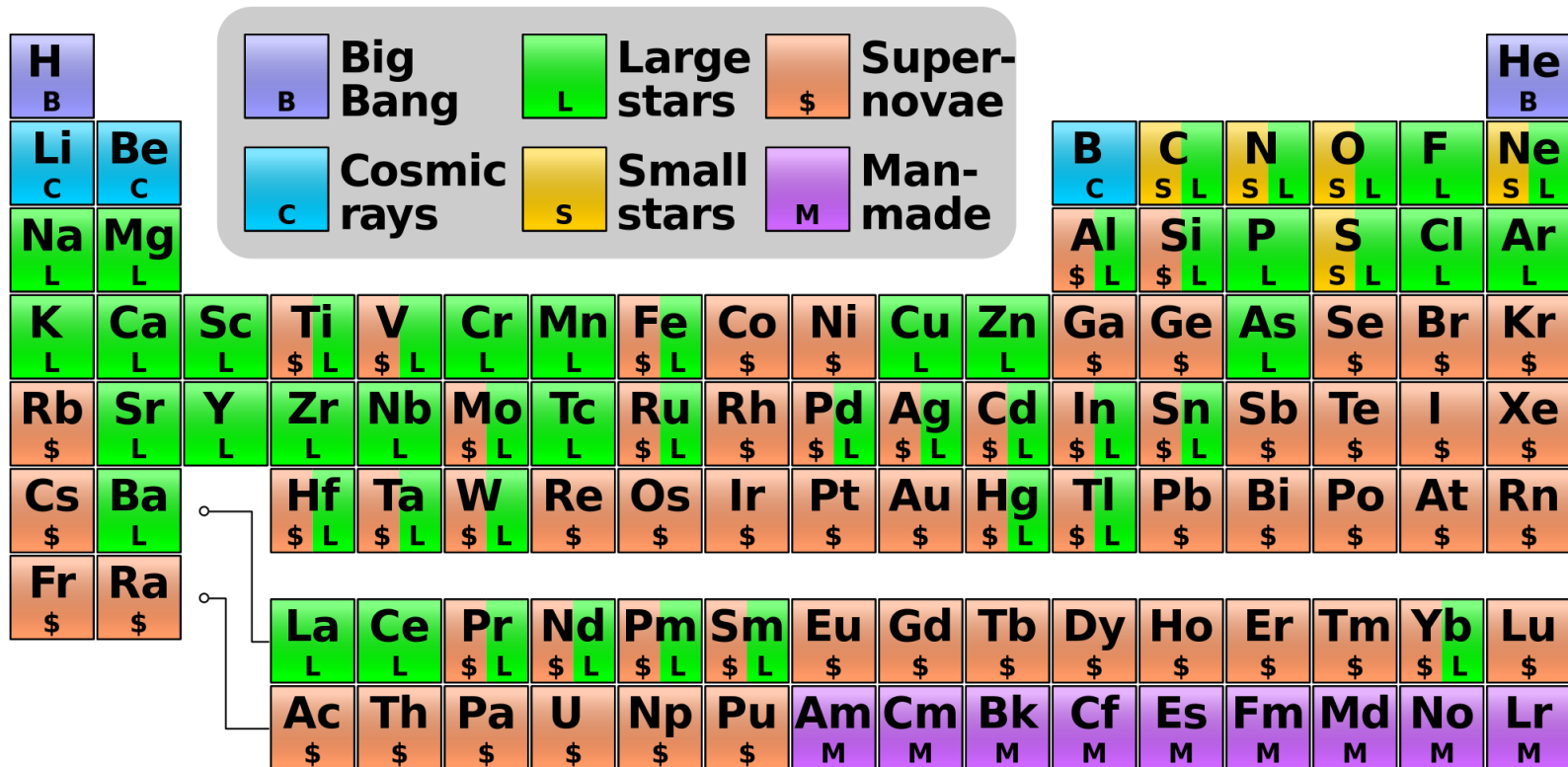

# STELLAR HELIUM BURNING

The Triple Alpha Process  
(Helium Fusion)

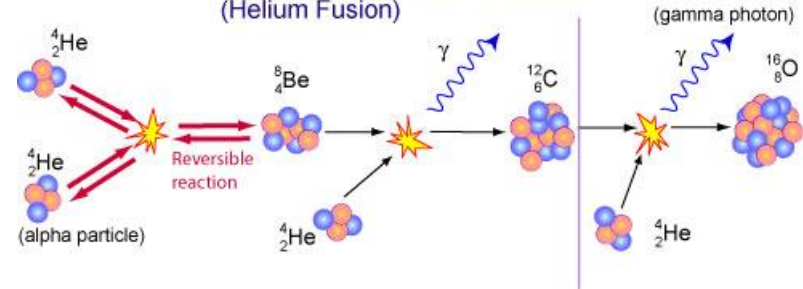

- Helium Reactions:



( $Q = -0.092 \text{ MeV}$ ,  $T_{1/2} \approx 10^{-16} \text{ s}$ )

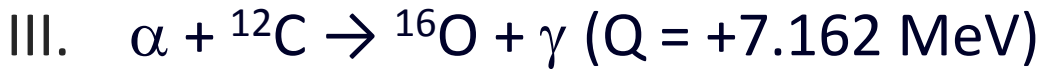

(slow, otherwise no  ${}^{12}\text{C}$  remains)



- $\alpha + {}^{12}\text{C}$  burns at very small cross section  $\sigma \approx 10^{-17} \text{ barn}$  ( $10^{-41} \text{ cm}^2$ )

➔ Currently, reaction rate error is large ( $\pm 35\%$ )

Goal  $< \pm 10\%$

- Thermonuclear reaction rate involving two nuclei is:

Only narrow energy range is relevant (Gamow Peak)

$$R = \sqrt{\frac{8}{\pi m (k_B T)^3}} \int_0^\infty E \sigma_{tot}(E) e^{-\frac{E}{k_B T}} dE$$

# THE $^{12}\text{C}(\alpha,\gamma)^{16}\text{O}$ Reaction

- The *holy grail* of nuclear astrophysics

Periodic Table of the Elements

\* Lanthanides  
 \* Actinides

Affects the synthesis of most of the elements of the periodic table

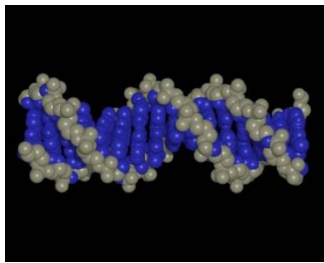

Sets the  $N(^{12}\text{C})/N(^{16}\text{O})$  ( $\approx 0.4$ ) ratio in the universe

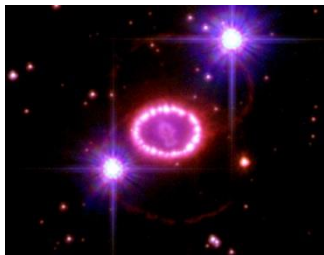

Determines the minimum mass a star requires to become a supernova

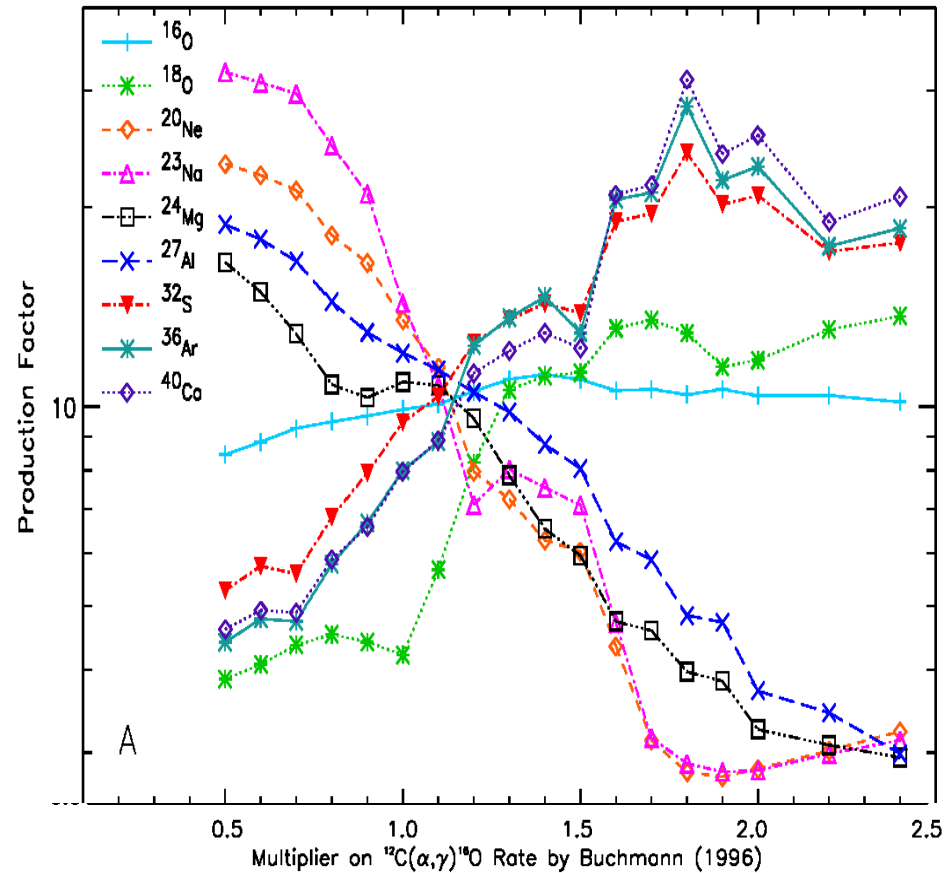



# THE GAMOW PEAK (WINDOW)

- Narrow energy range where thermonuclear reactions is most likely to occur in stellar plasma is a product of two distributions:

- I. Maxwell-Boltzmann energy distribution with  $e^{-E/k_B T}$
- II. Penetration through Coulomb barrier with  $e^{-b/E^{1/2}}$

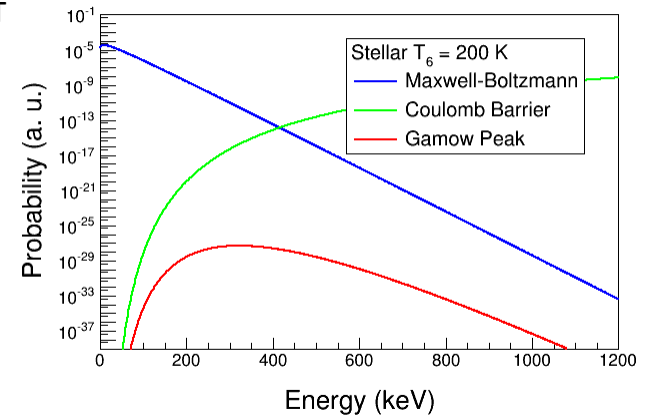

- For  $\alpha + {}^{12}\text{C}$ , and stellar  $T=200 \cdot 10^6$  K:

➤ **Gamow Peak,  $E_0 \approx 300$  keV, Width  $\approx 50$  keV (in Center-of-Mass (CM) of  $\alpha + {}^{12}\text{C}$  system)**

➤ Maximum of Maxwell-Boltzmann energy distribution,  $k_B T = 17$  keV

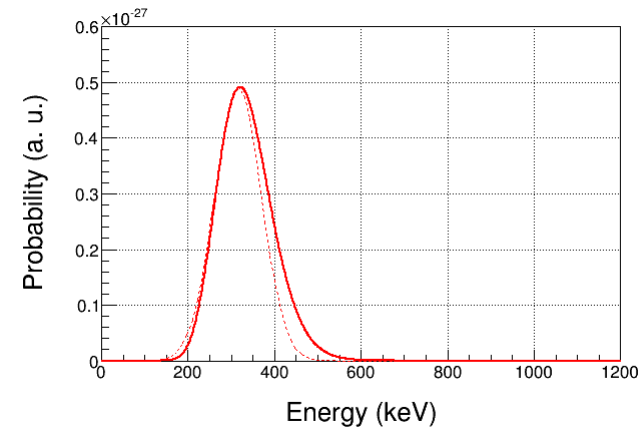



# $\alpha + {}^{12}\text{C}$ REACTION

- $\alpha$  ( $J^\pi=0^+$ ) +  ${}^{12}\text{C}$  ( $J^\pi=0^+$ ) cross section,  $\sigma(E_0)$ , is dominated by  $p$ -wave (E1) and  $d$ -wave (E2) radiative capture to  ${}^{16}\text{O}$  ground state ( $J^\pi=0^+$ )
- Two bound states, at 6.92 MeV ( $J^\pi=2^+$ ) and 7.12 MeV ( $J^\pi=1^-$ ), with sub-threshold resonances at  $E_R=-0.245$  and  $-0.045$  MeV, provide most of  $\sigma(E_0)$  through their finite widths
- Distinguish E1 and E2 by measuring  $\gamma$ -angular distributions

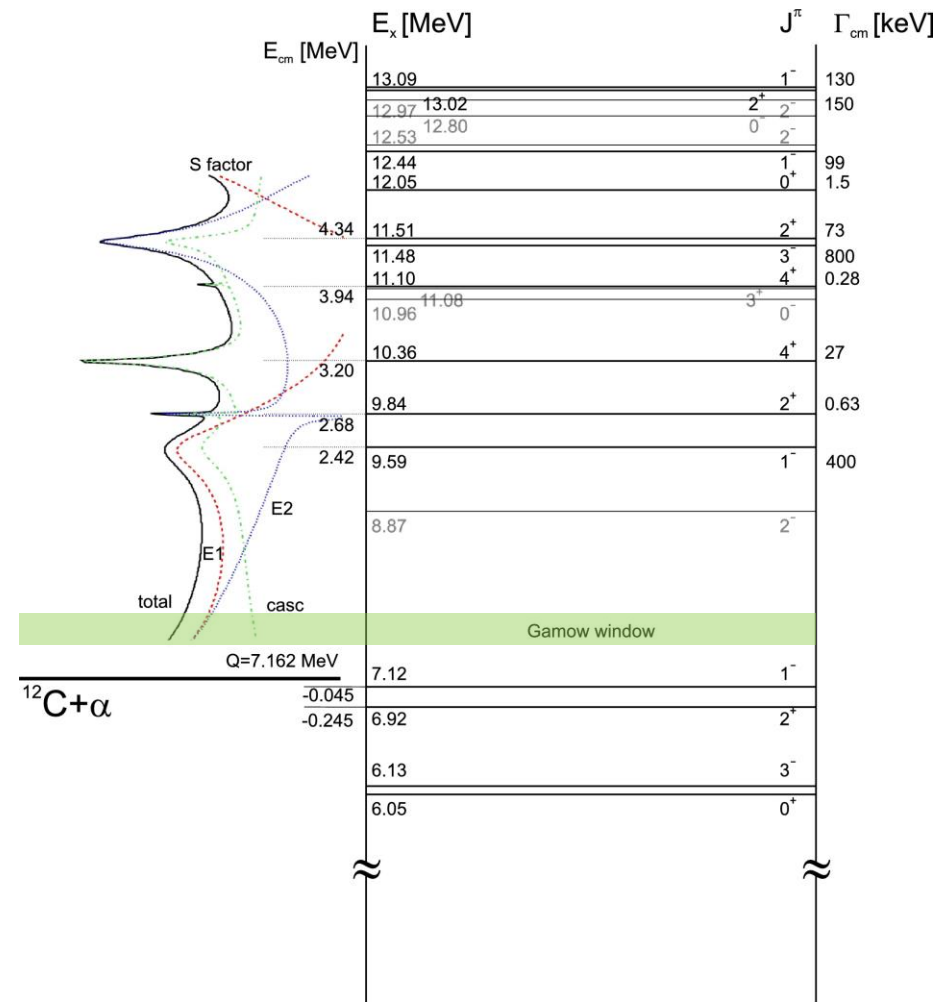

# Heroic efforts in search of $^{12}\text{C}(\alpha,\gamma)^{16}\text{O}$

## ➤ Previous Experiments:

### A. Direct Measurements:

- I. Helium ions on carbon target:  $^{12}\text{C}(\alpha,\gamma)^{16}\text{O}$
- II. Carbon ions on helium gas:  $^4\text{He}(^{12}\text{C},\gamma)^{16}\text{O}$  or  $^4\text{He}(^{12}\text{C},^{16}\text{O})\gamma$  (Schürmann)

Experiment	Beam Current (mA)	Target (nuclei/cm <sup>2</sup> )	Time (h)
Redder	0.7	$^{12}\text{C}$ , $3 \cdot 10^{18}$	900
Ouellet	0.03	$^{12}\text{C}$ , $5 \cdot 10^{18}$	1950
Roters	0.02	$^4\text{He}$ , $1 \cdot 10^{19}$	5000
Kunz	0.5	$^{12}\text{C}$ , $3 \cdot 10^{18}$	700
EUROGAM	0.34	$^{12}\text{C}$ , $1 \cdot 10^{19}$	2100
GANDI	0.6 (?)	$^{12}\text{C}$ , $2 \cdot 10^{18}$	?
Schürmann	0.01	$^4\text{He}$ , $4 \cdot 10^{17}$	?
Plag	0.005	$^{12}\text{C}$ , $6 \cdot 10^{18}$	278

### B. Indirect Measurements:

- I.  $\beta$ -delayed  $\alpha$  decay of  $^{16}\text{N}$  ( $J^\pi=2^-$ ,  $T_{1/2}=7.13$  s, BR=0.12%)  
 $^{16}\text{N} \rightarrow \beta^- + ^{16}\text{O}^* (J^\pi=1^-) \rightarrow \alpha + ^{12}\text{C}$

# ASTROPHYSICAL S-FACTOR $^{12}\text{C}(\alpha,\gamma)^{16}\text{O}$

- Define *S-Factor* to remove both  $1/E$  dependence of nuclear cross sections and Coulomb barrier transmission probability:

$$S \equiv E_{CM} \sigma(\alpha, \gamma) e^{2\pi\eta}$$

$$\eta = \frac{1}{137} Z_{\alpha} Z_{^{12}\text{C}} \sqrt{\frac{m_{^{12}\text{C}\alpha}}{2E_{CM}}}$$

Author	$S_{\text{tot}}(300)$ (keV b)
Hammer (2005)	$162 \pm 39$
Kunz (2001)	$165 \pm 50$

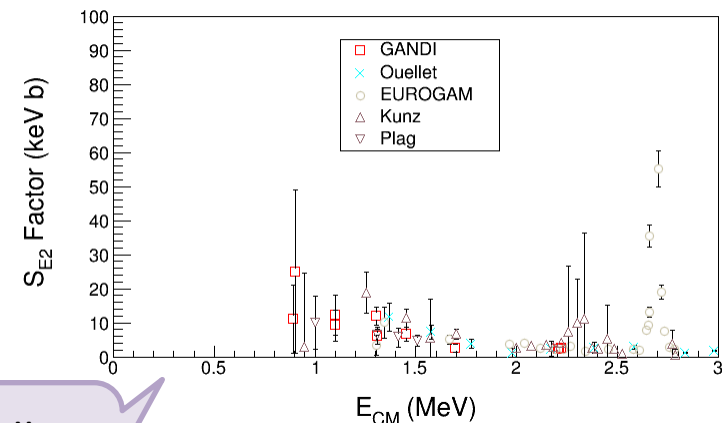
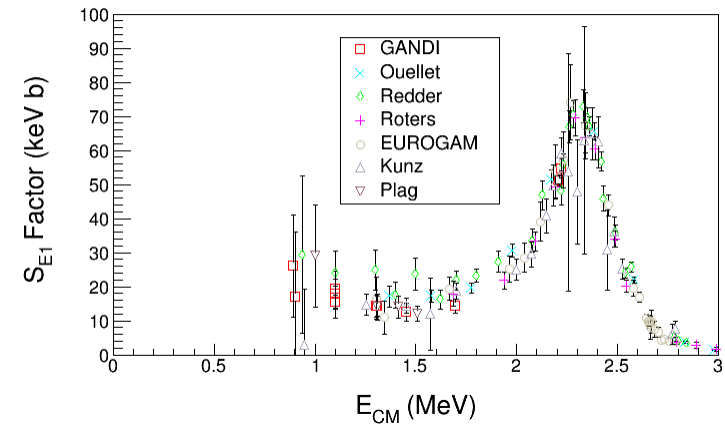

R-matrix Extrapolation to stellar helium burning at  $E = 300$  keV

# TIME REVERSAL REACTION

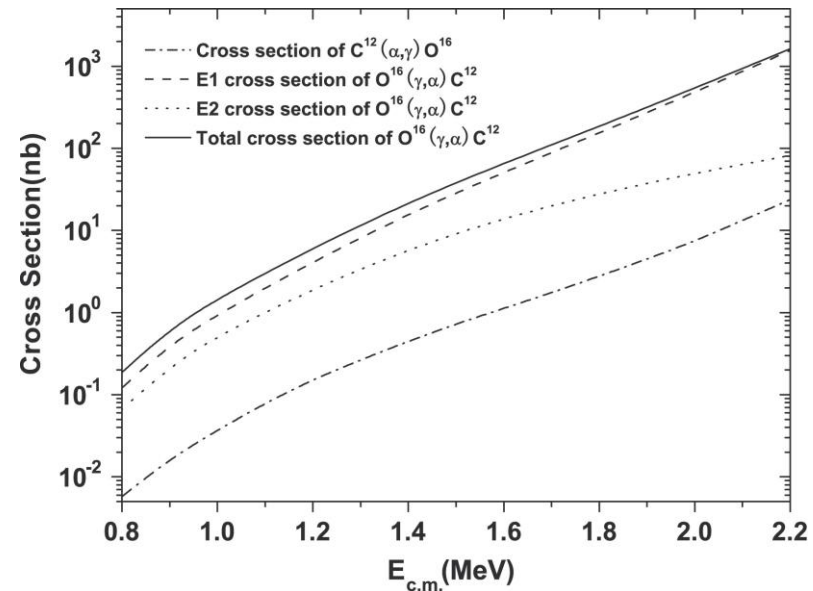
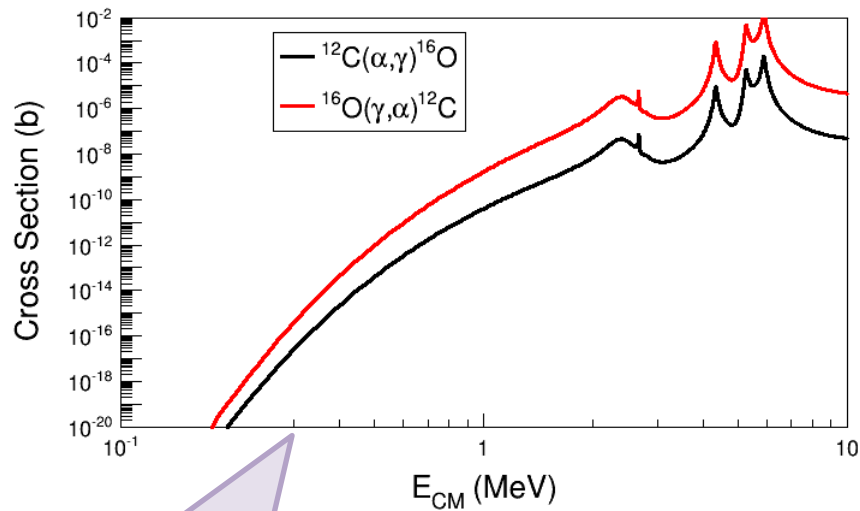
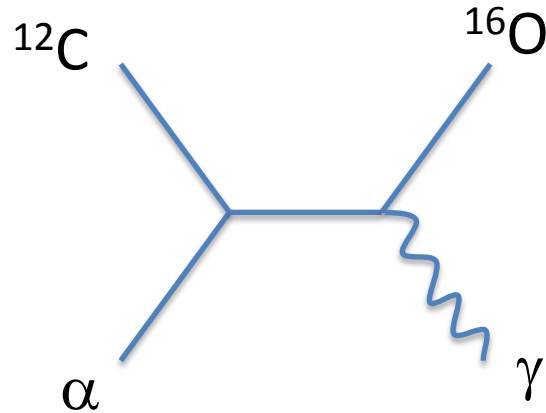

Stellar helium burning  
at  $E = 300 \text{ keV}$

# RECIPROCITY RELATION: $(\gamma, \alpha)$ and $(\alpha, \gamma)$

➤  $A(\alpha, \gamma)B$ :

$$\sigma_{B\gamma}^{j \rightarrow i}(E_\gamma) = \frac{(2J_i + 1)(2J_\alpha + 1)}{2J_j + 1} \frac{m_{A\alpha} c^2 E_{A\alpha}}{E_\gamma^2} \sigma_{A\alpha}^{i \rightarrow j}(E_{A\alpha})$$

$$m_{A\alpha} c^2 = \frac{M(^{12}\text{C}) \cdot M(\alpha)}{M(^{12}\text{C}) + M(\alpha)} = 2796 \text{ MeV} \quad J_i = 0, J_j = 0, J_\alpha = 0$$

$$E_{A\alpha} = E_{CM}$$

$$Q = m_A + m_\alpha - m_B = +7.162 \text{ MeV}$$

$$E_{CM} = \sqrt{m_B^2 + 2E_\gamma m_B} - m_B - Q$$

$$E_\gamma \cong E_{CM} + Q$$

$$\sigma_{(\gamma, \alpha)}(E_\gamma) = \frac{m_{A\alpha} c^2 E_{CM}}{E_\gamma^2} \sigma_{(\alpha, \gamma)}(E_{CM})$$

➤  $\sigma(\gamma, \alpha)$  is over two orders of magnitude larger than  $\sigma(\alpha, \gamma)$

# NEW APPROACH: REVERSAL REACTION + BUBBLE CHAMBER

- Extra gain (factor of 100) by measuring time reversal reaction
- Target density up to  $10^4$  higher than conventional targets. Number of  $^{16}\text{O}$  nuclei =  $3.5 \cdot 10^{22} / \text{cm}^2$  (3.0 cm cell)
- Measures total cross section  $\sigma_{\text{tot}}$  (or  $S_{\text{tot}}$ )
- Solid Angle and Detector Efficiency = 100%
- Electromagnetic debris (electrons and gammas, or positrons) do NOT trigger nucleation (detector is insensitive to  $\gamma$ -rays by at least 1 part in  $10^{11}$ ).

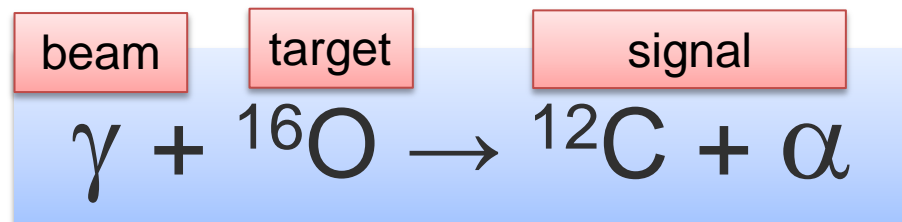

- Monochromatic  $\gamma$  beam at HIGS  $\approx 10^{7-8} \gamma/\text{s}$
- Bremsstrahlung at JLab  $\approx 10^9 \gamma/\text{s}$  (top 250 keV)

# THE BUBBLE CHAMBER

- Donald Glaser won Nobel Prize for inventing chamber to detect particles (1960)
- Now being used in Dark Matter Search Experiments: COUPP, PICASSO, SIMPLE

## Superheat Preparation:

- Liquid is pressurized at ambient temperature (1 to 2)
- Then pressure is kept constant while temperature is increased to above boiling point (2 to 3)
- Finally pressure is slowly released while keeping temperature constant (3 to 4)
- At this point (4), still liquid but now superheated

## Bubble Formation:

- Particle energy loss will induce vaporization
- Resultant vapor bubble is observable either **visibly** or **audibly**
- Bubble growth is captured by a digital camera
- Pressure is increased (4 to 3) to quench bubble. It takes about a second for liquid to return to a stable state
- Superheat is restored by releasing pressure again (3 to 4), and cycle is repeated for each bubble event

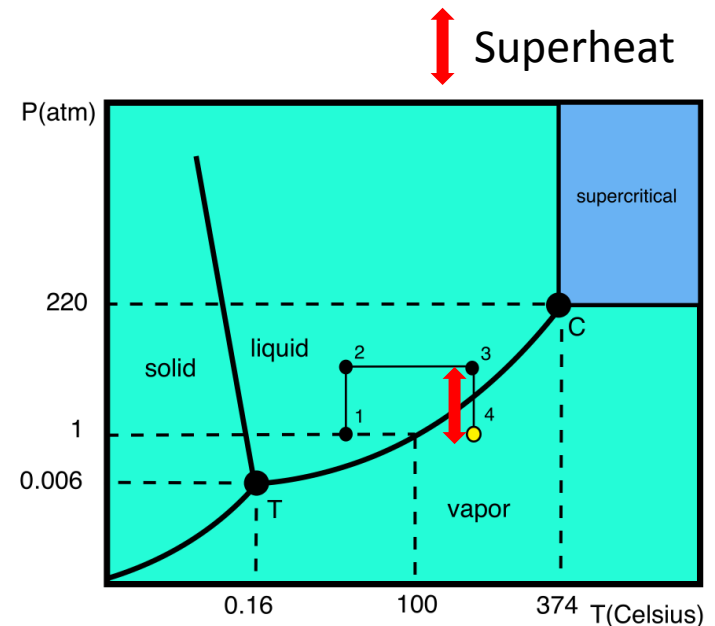



# BUBBLE GROWTH AND QUENCHING

$^{19}\text{F}(\gamma, \alpha)^{15}\text{N}$  event in  $\text{C}_4\text{F}_{10}$  at HIGS

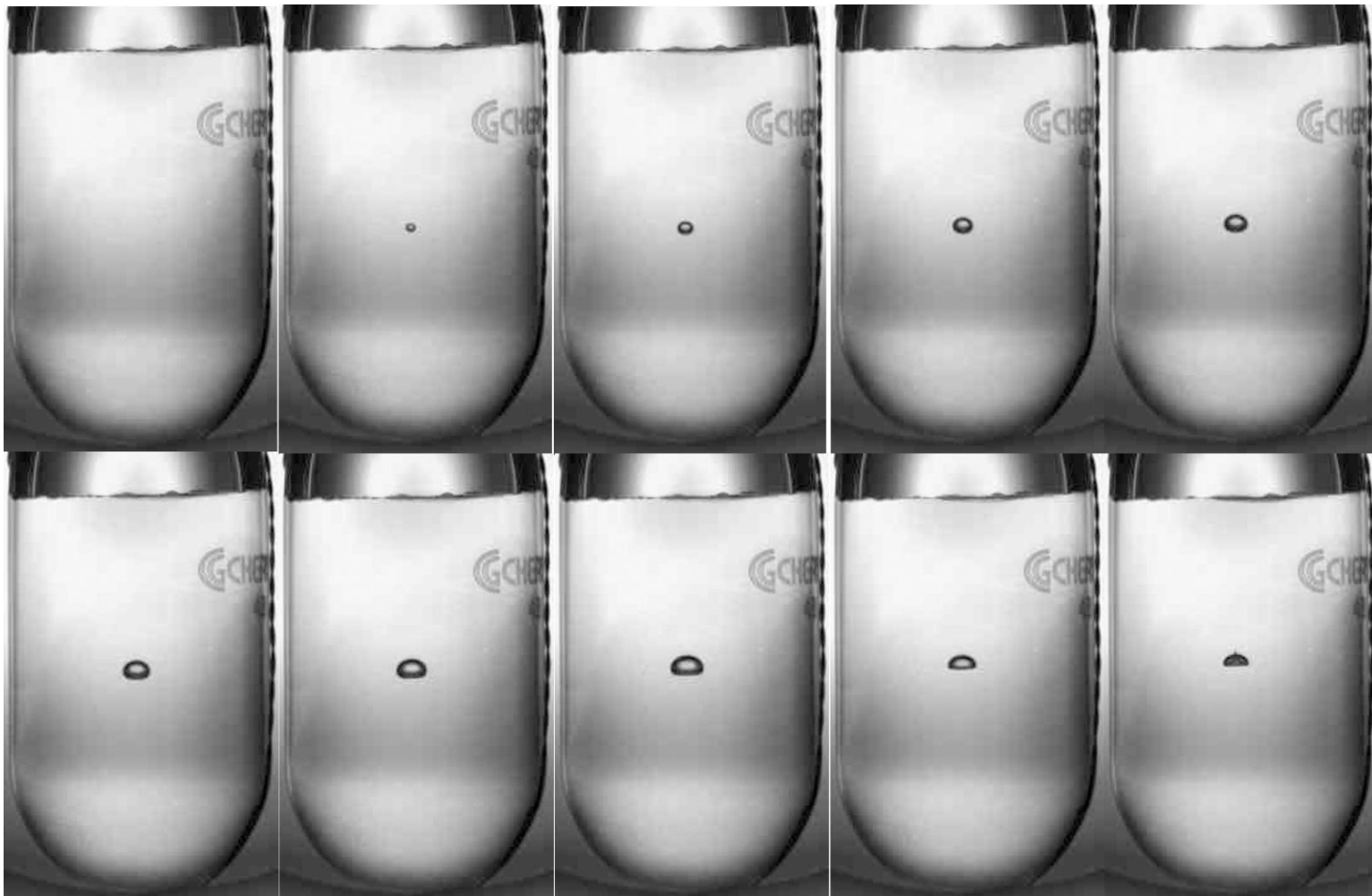

3.0 cm

100 Hz Digital Camera:  $\Delta t = 10$  ms

# ACOUSTIC SIGNAL DISCRIMINATION

I. Bubble growth produces an audible click which is recorded by piezo-electric transducers

II. Neutron Events:

I.  $^{17}\text{O}(\gamma, n)^{16}\text{O}$

II. Neutron–nucleus elastic scattering:  
 $^{16}\text{O}(n, n)$ ,  $^{14}\text{N}(n, n)$

Ions  $^{16}\text{O}$  or  $^{14}\text{N}$  will generate a single bubble

III. Alpha Events:

I.  $^{16}\text{O}(\gamma, \alpha)^{12}\text{C}$

II.  $^{17}\text{O}(\gamma, \alpha)^{13}\text{C}$

III.  $^{18}\text{O}(\gamma, \alpha)^{14}\text{C}$

Ions  $^{12}\text{C}+\alpha$  or  $^{13}\text{C}+\alpha$  or  $^{14}\text{C}+\alpha$  will generate a combined multi-bubble

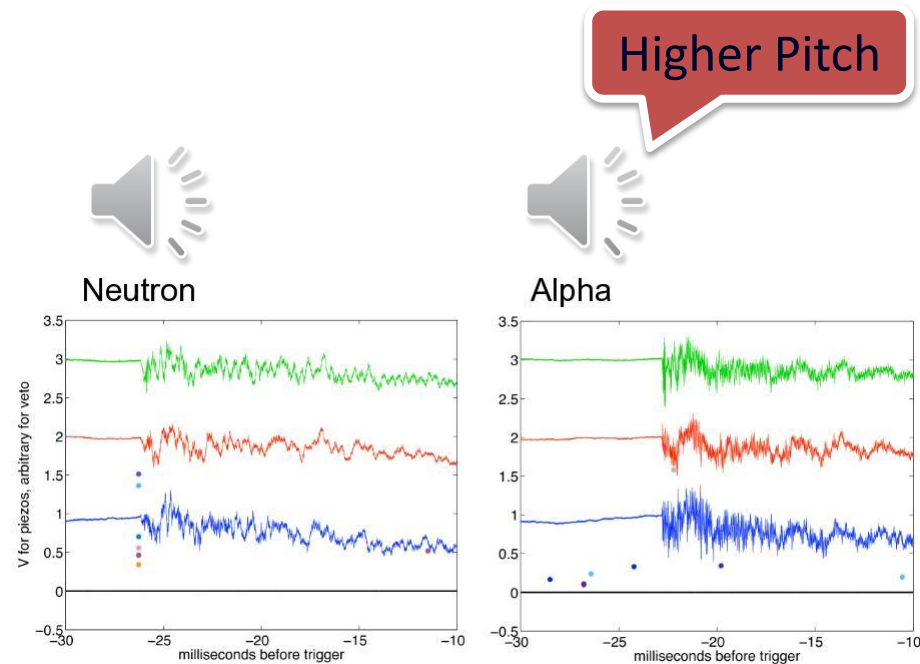

COUPP, FNAL, courtesy of A. Sonnenschein

Suppress neutron events  
by 100 using acoustic  
signal

# BUBBLE CHAMBER PRINCIPLE

I. For bubble formation, particle must be over thresholds in both **E** and **dE/dx**

$$E \geq E_c = \frac{4}{3} \pi R_c^3 (\rho h + P_l) + 4\pi R_c^2 \left( s - T \frac{\partial s}{\partial T} \right)$$

II. Only bubbles with  $r > R_c$  grow to be macroscopic

$$R_c = 2s / (P_v - P_l)$$

s: Surface tension

III. Bubble requires minimum deposited energy ( $E_c$ ) within minimum distance  $L_c (=aR_c, 10\text{s of nm to a few } \mu\text{m})$

$$\frac{dE}{dx} > \left( \frac{dE}{dx} \right)_c = \frac{E_c}{aR_c}$$

$a$ : free parameter (to determined experimentally)

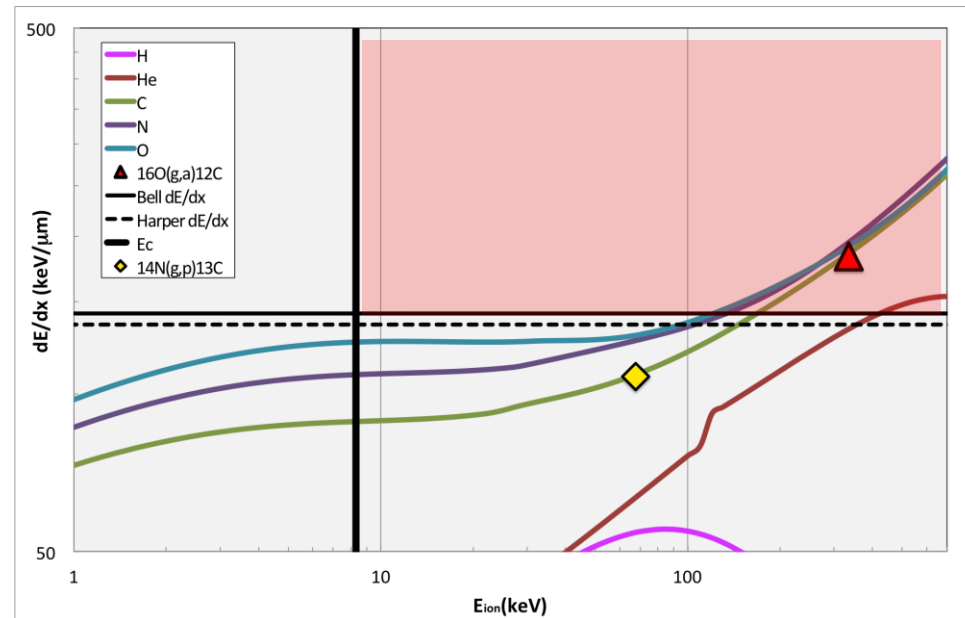

# EFFICIENCY CURVE

$N_2O$  thresholds  
Superheat =  $3.3^\circ C$

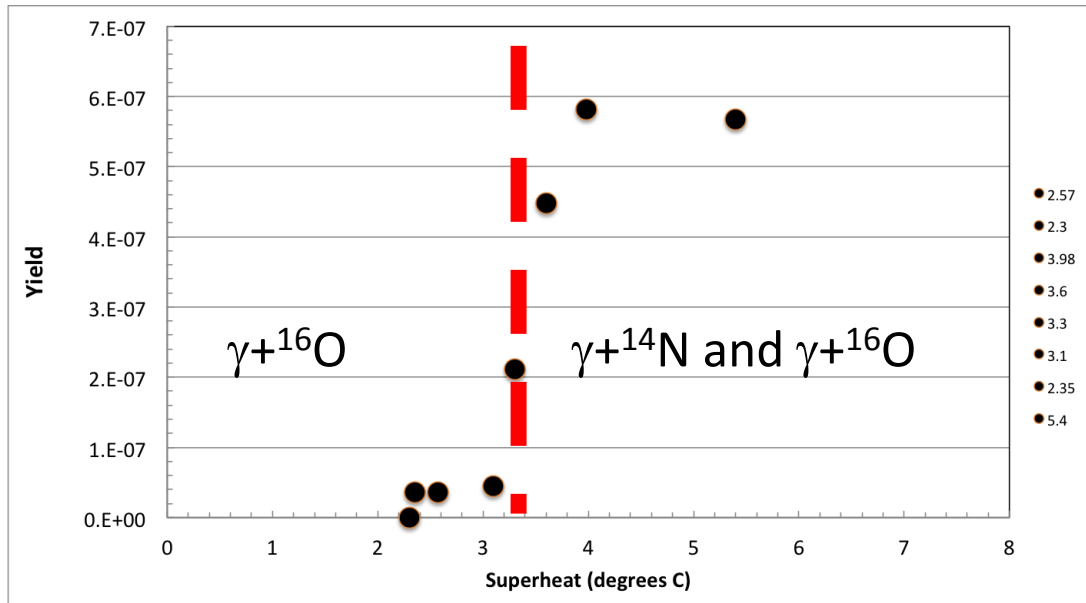
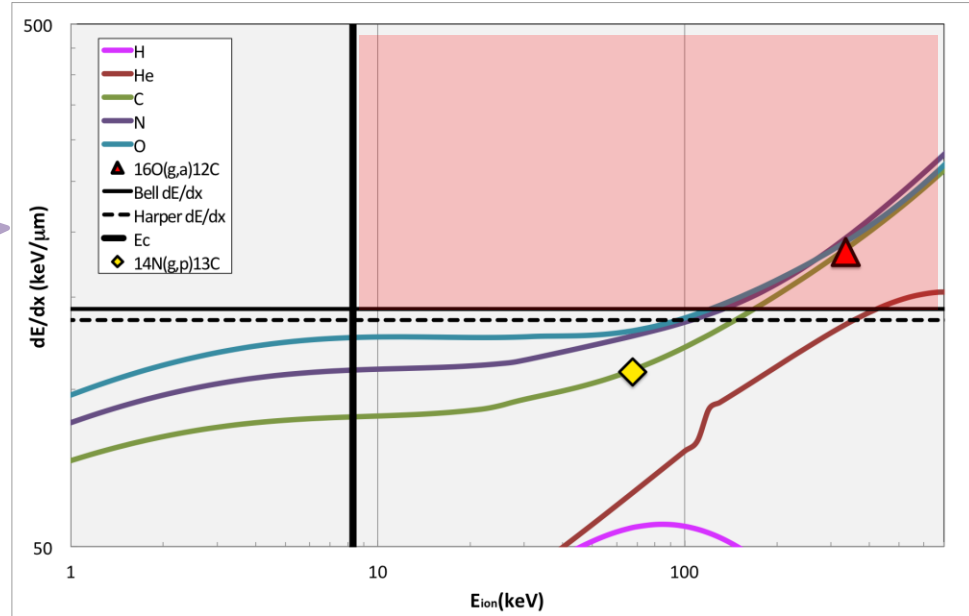

$N_2O$  efficiency curve,  
HIGS April 2013,  
 $E_\gamma = 9.7$  MeV

# BUBBLE CHAMBER AT HIGS

- I. High Intensity Gamma Source (HIGS) at Duke University
- II.  $\gamma$ -rays generated by Compton backscattering of free-electron-laser (FEL) light from high-energy electron beam bunches

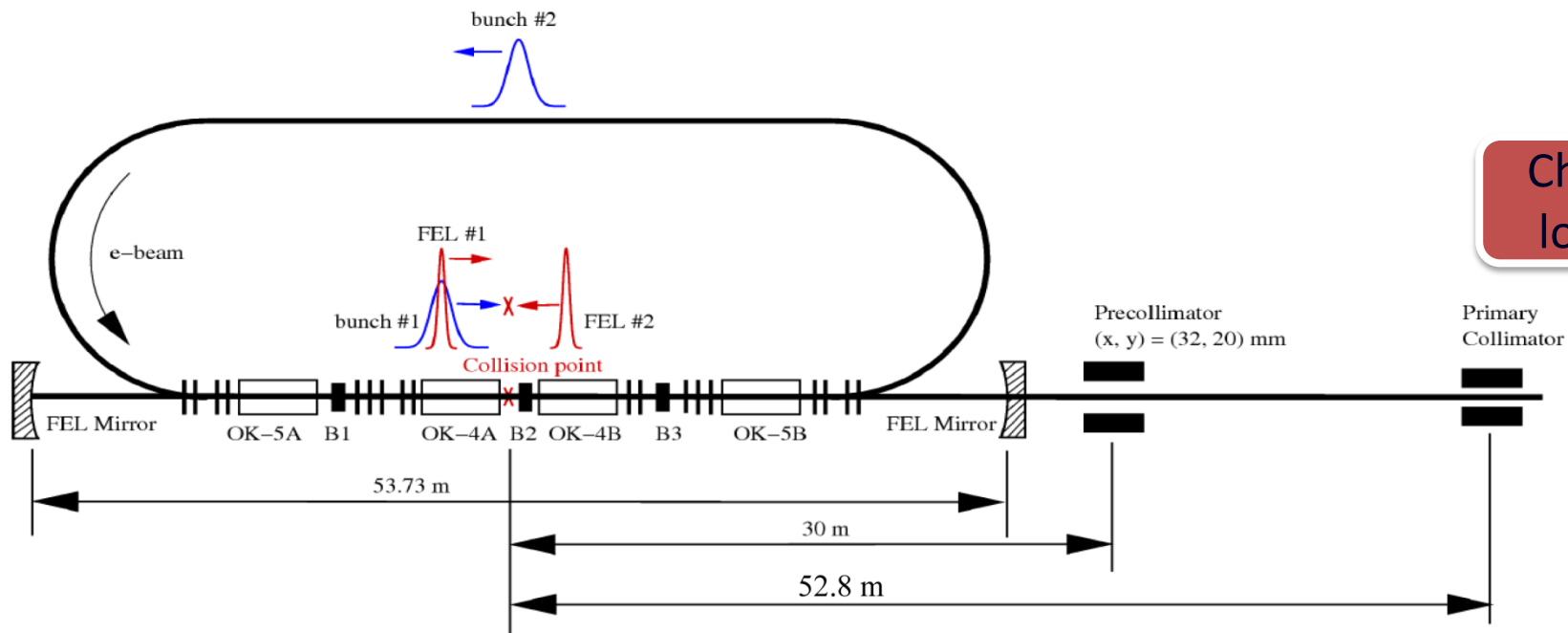

# MEASURING $^{19}\text{F}(\gamma, \alpha)^{15}\text{N}$ AT HIGS

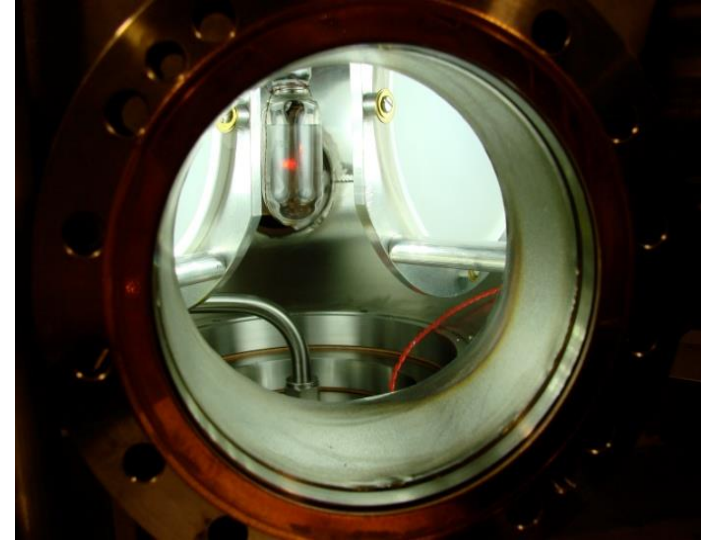
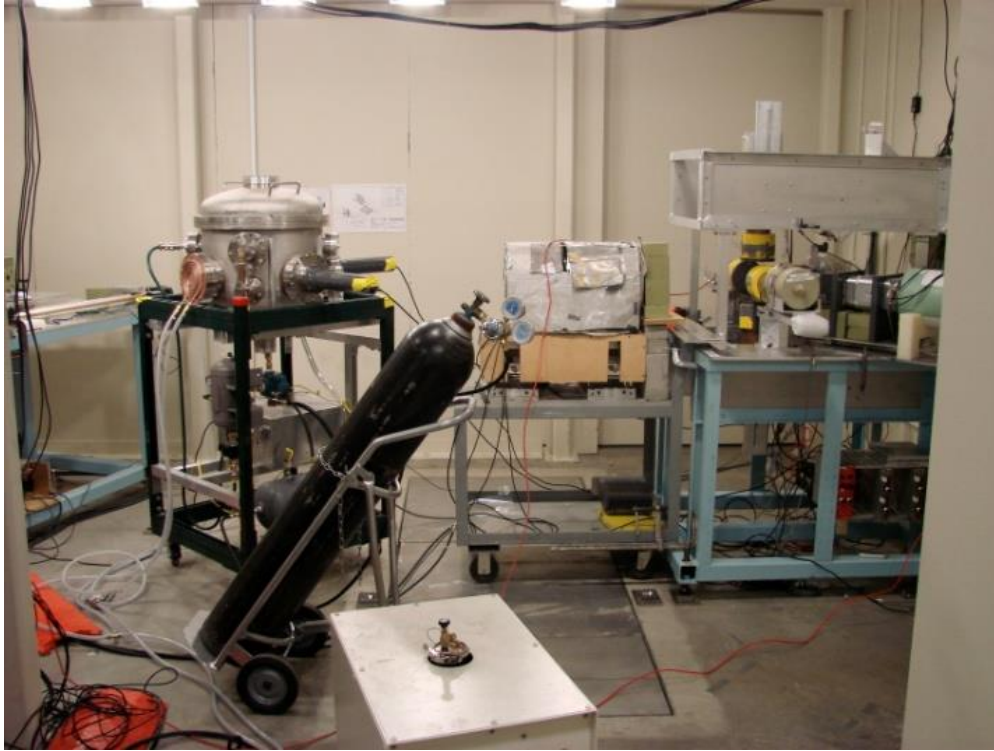

$\text{C}_4\text{F}_{10}$  Bubble Chamber  
 $T = 30^\circ\text{C}$   
 $P = 3 \text{ atm}$

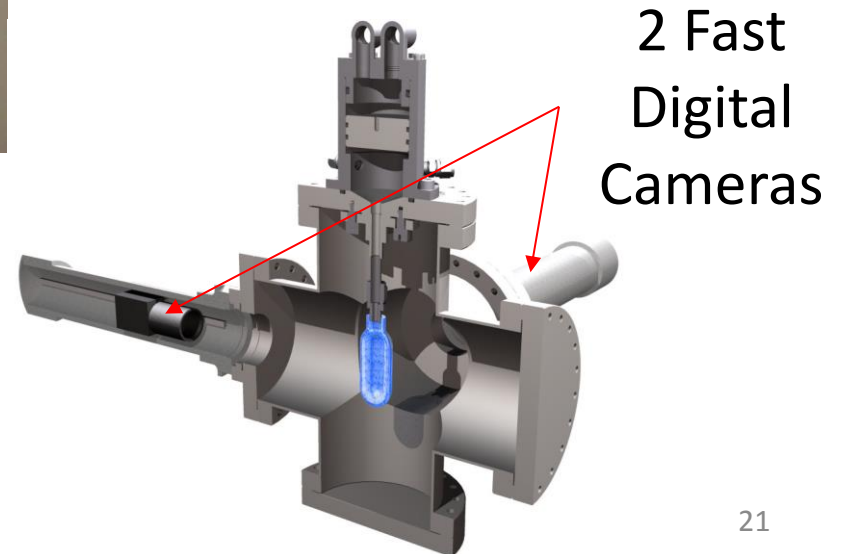





Contents lists available at [SciVerse ScienceDirect](http://SciVerse ScienceDirect)

Physics Letters B

[www.elsevier.com/locate/physletb](http://www.elsevier.com/locate/physletb)



## First determination of an astrophysical cross section with a bubble chamber: The $^{15}\text{N}(\alpha, \gamma)^{19}\text{F}$ reaction

C. Ugalde <sup>a,\*</sup>, B. DiGiovine <sup>b</sup>, D. Henderson <sup>b</sup>, R.J. Holt <sup>b</sup>, K.E. Rehm <sup>b</sup>, A. Sonnenschein <sup>c</sup>, A. Robinson <sup>d</sup>,  
R. Raut <sup>e,f,1</sup>, G. Rusev <sup>e,f,2</sup>, A.P. Tonchev <sup>e,f,3</sup>

<sup>a</sup> Department of Astronomy and Astrophysics, University of Chicago, Chicago, IL 60637, USA

<sup>b</sup> Physics Division, Argonne National Laboratory, Argonne, IL 60439, USA

<sup>c</sup> Fermi National Accelerator Laboratory, Batavia, IL 60510, USA

<sup>d</sup> Department of Physics, University of Chicago, Chicago, IL 60637, USA

<sup>e</sup> Department of Physics, Duke University, Durham, NC 27708, USA

<sup>f</sup> Triangle Universities Nuclear Laboratory, Durham, NC 27708, USA

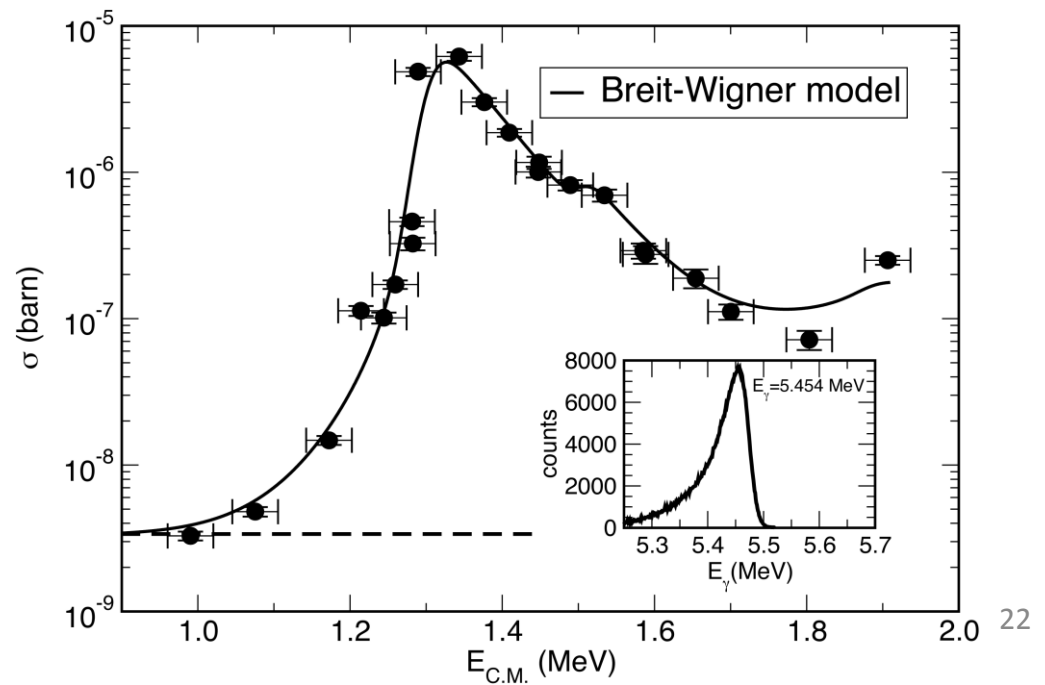
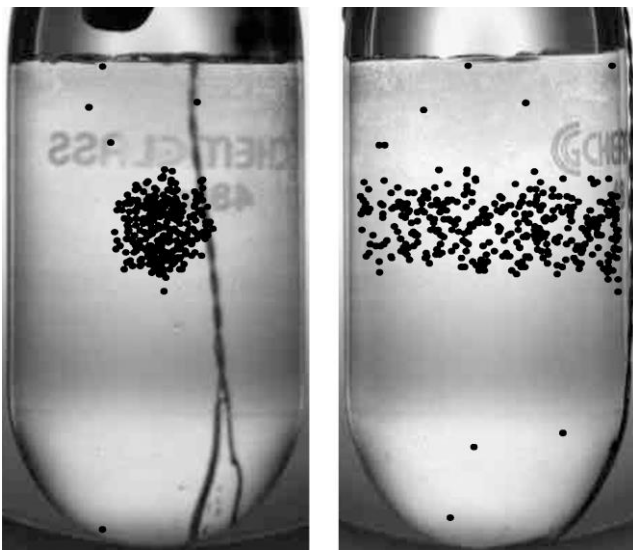



# BREMSSTRAHLUNG BACKGROUND AT HIGS

Electron Beam Energy: 400 MeV

Electron Beam Current: 41 mA

Interaction Length: 35 m

Vacuum:  $2 \times 10^{-10}$  Torr

Residual Gas:  $Z = 10$

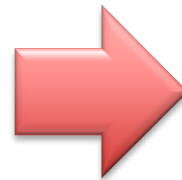

Strong Bremsstrahlung  
Background  
(when coupled with large  
cross sections at high energies)

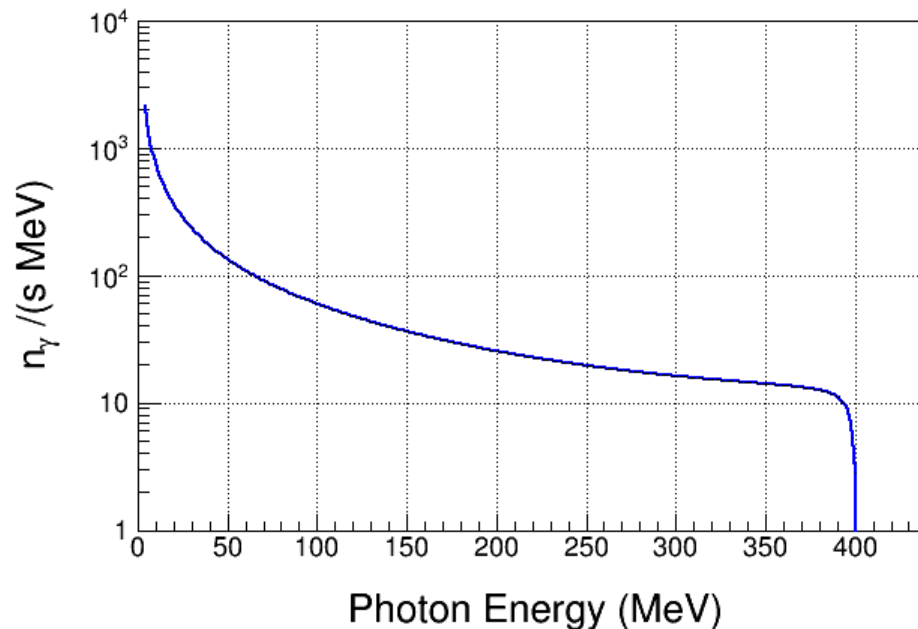

# N<sub>2</sub>O (LAUGHING GAS) BUBBLE CHAMBER

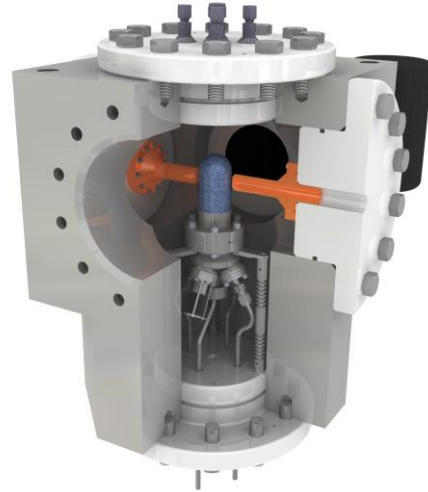
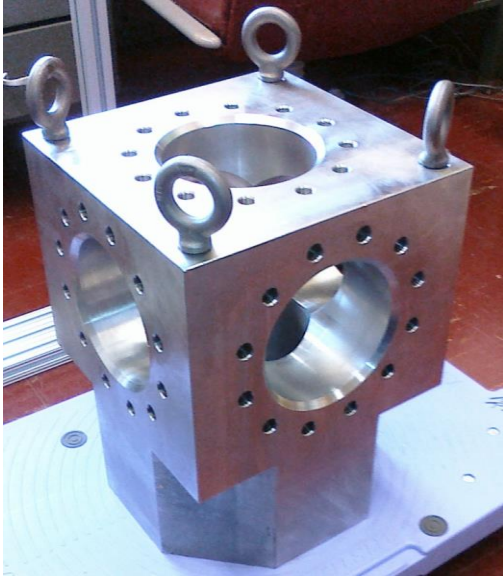

$T = -5^{\circ}\text{C}$

$P = 60 \text{ atm}$

First  $\gamma + \text{O} \rightarrow \alpha + \text{C}$  bubble  
HIGS, April 2013

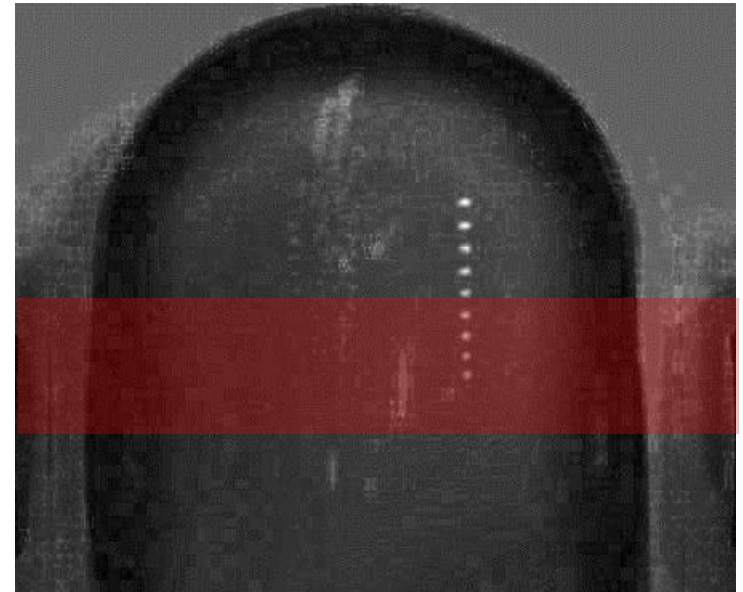
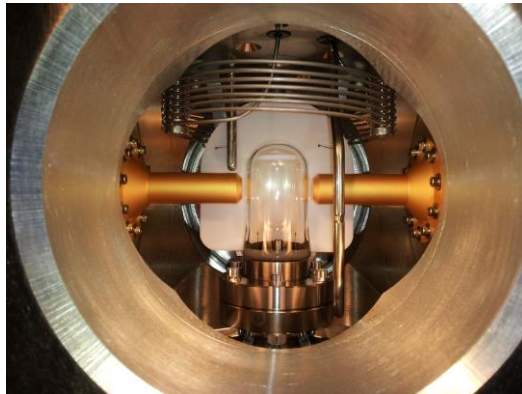

# EXPERIMENTAL SETUP AT JLAB INJECTOR

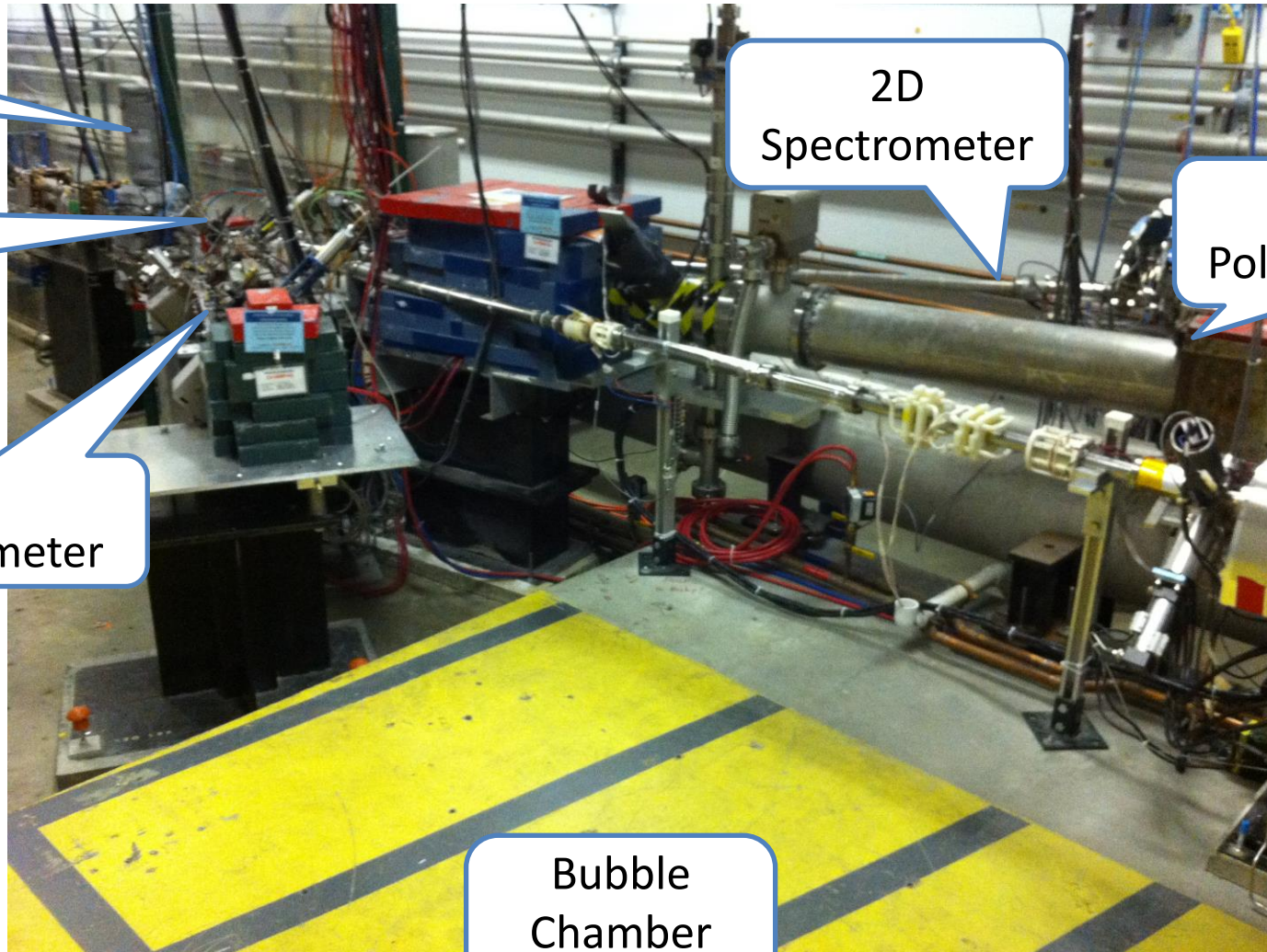

BCM

5 MeV  
Dipole

5D  
Spectrometer

2D  
Spectrometer

Mott  
Polarimeter

Bubble  
Chamber  
location





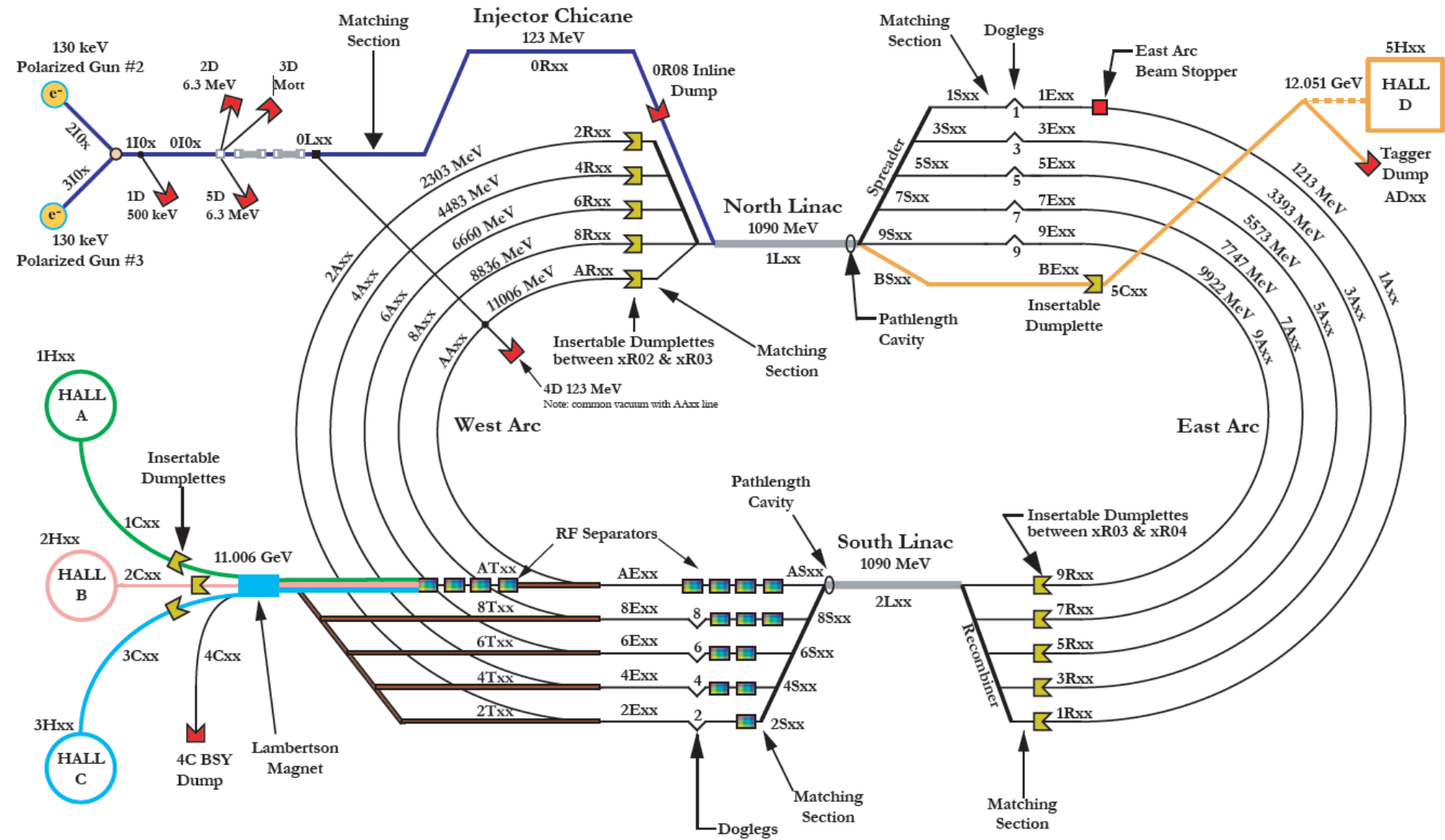



# BEAMLINE

Bubble Chamber at  
HIGS April 2013

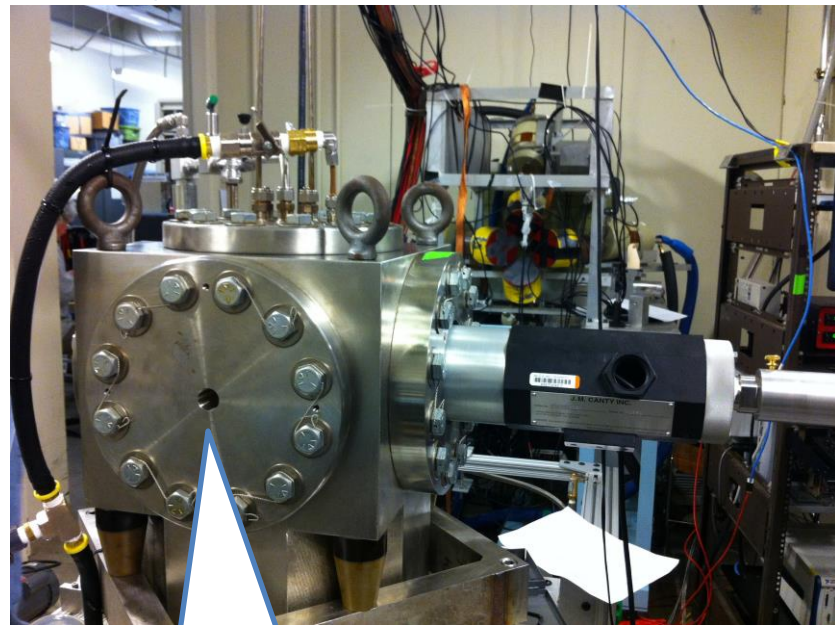
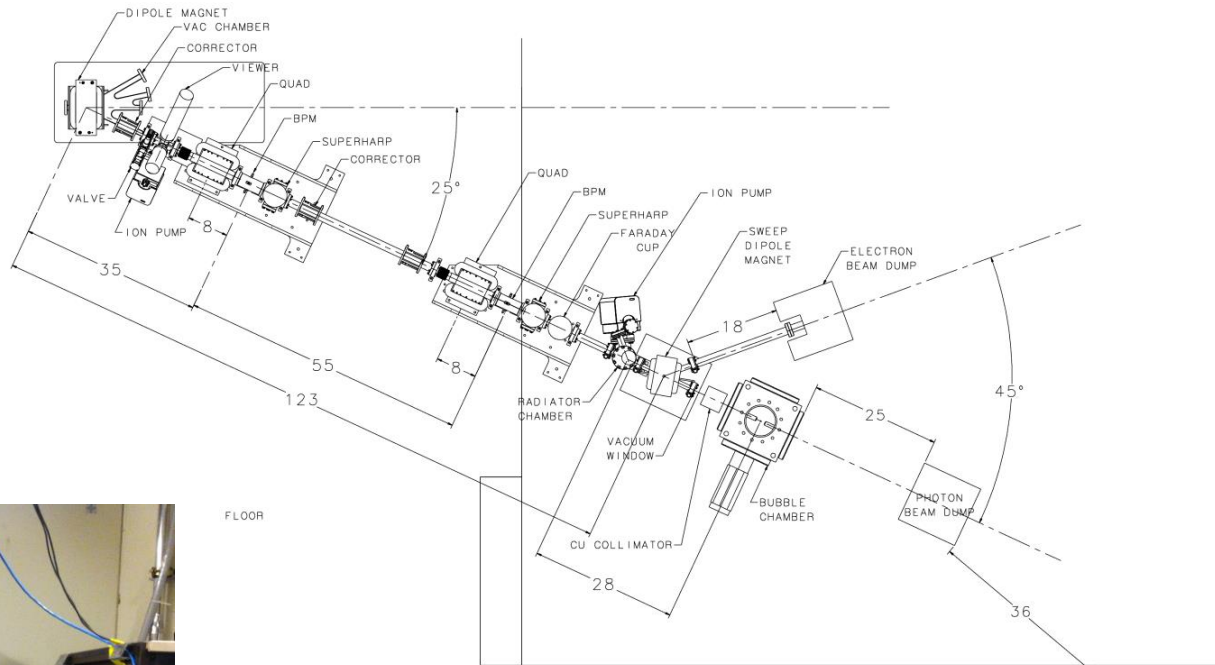

Photon Beam  
Entrance

Beam Kinetic Energy, (MeV)	7.9–8.5
Beam Current ( $\mu\text{A}$ )	0.01–100
Absolute Beam Energy Uncertainty	<0.1%
Relative Beam Energy Uncertainty	<0.02%
Energy Resolution (Spread), $\sigma_T/T$	<0.06%
Beam Size, $\sigma_{x,y}$ (mm)	1–2

Electron Beam  
Requirements at Radiator

# SCHEMATICS

- Power deposited in radiator (100  $\mu\text{A}$  and 8.5 MeV) :
  - I. 0.02 mm: Energy loss = 21 keV,  $P = 2.1 \text{ W}$
- Pure Copper and Aluminum (high neutron threshold):
  - I.  $^{63}\text{C}(\gamma, n)$  threshold = 10.86 MeV
  - II.  $^{27}\text{Al}(\gamma, n)$  threshold = 13.06 MeV

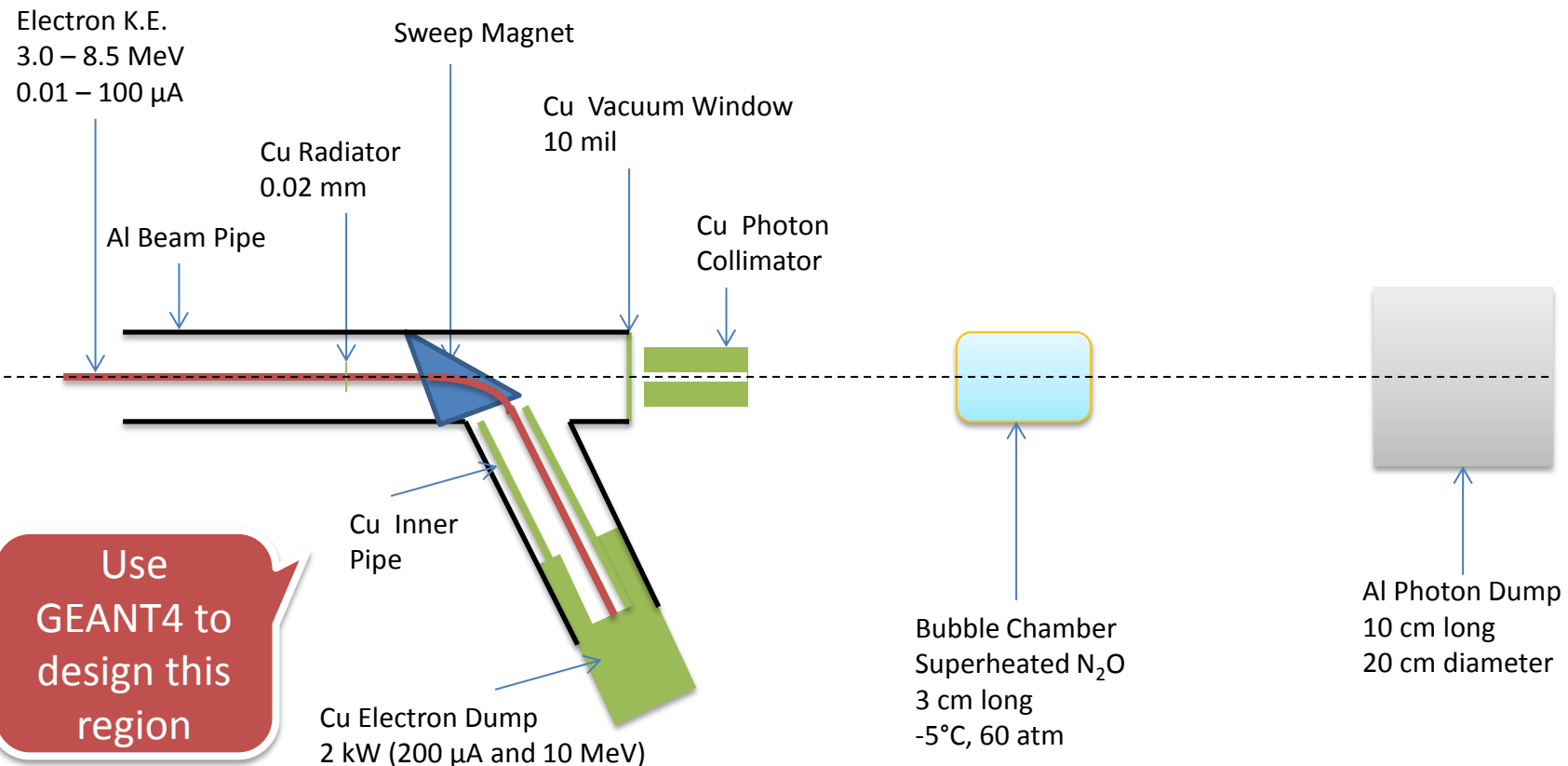



# MEASURING ABSOLUTE BEAM ENERGY

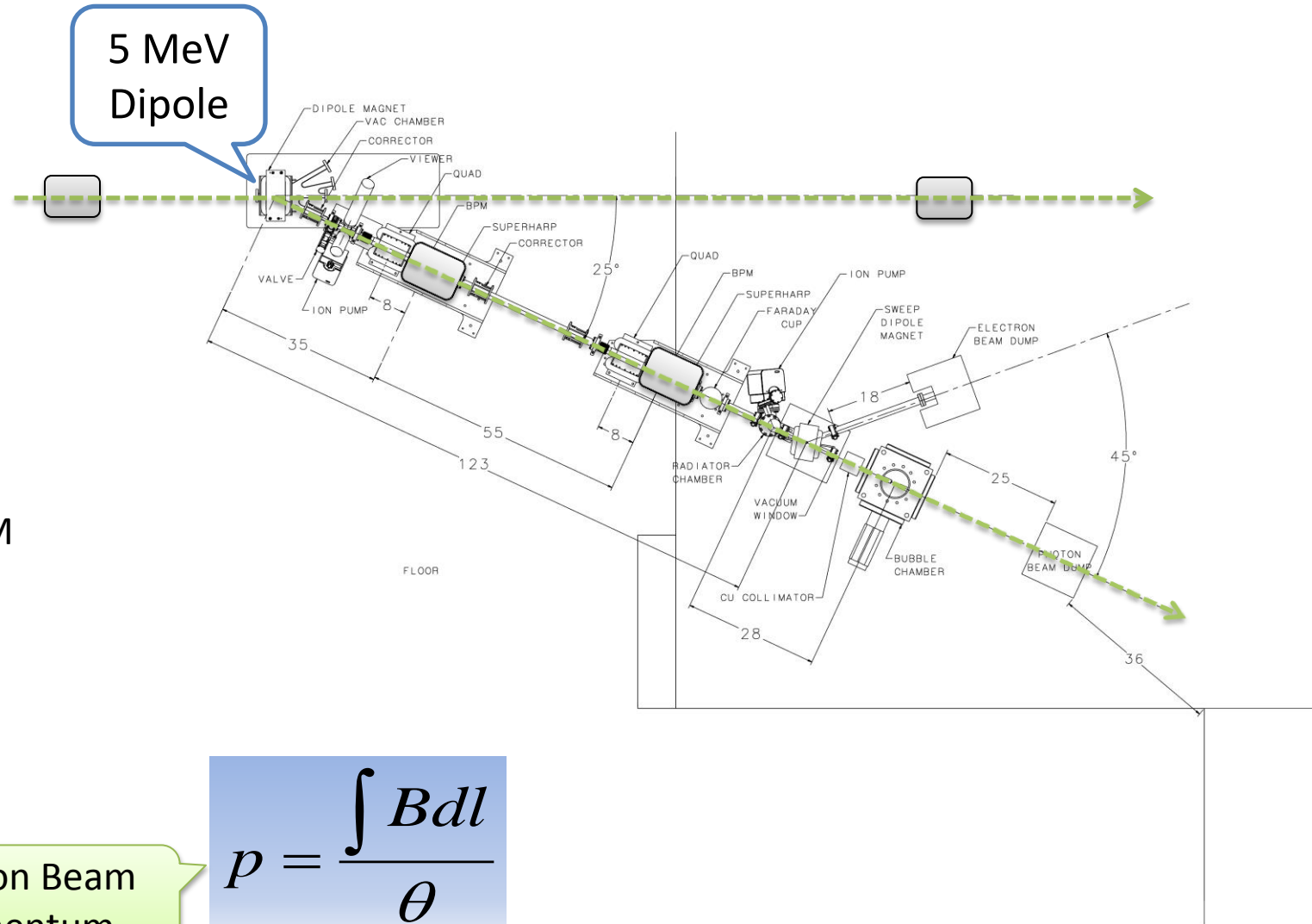

 BPM

Electron Beam Momentum

$$p = \frac{\int Bdl}{\theta}$$

Parameter	Term	Now	Goal
Dipole – linearity	$\delta B/B$	0.25%	0.02%
Dipole – spatial	$\delta BL/BL$	0.10%	0.02%
Dipole – reproduce	$\delta B/B$	0.10%	0.02%
Dipole – power supply	$\delta I/I$	0.20%	0.02%
Position – surveys	$\delta \theta/\theta$	0.01%	0.01%
Position – BPM calibration	$\delta \theta/\theta$	0.05%	0.05%
Stray magnetic field	$\delta \theta/\theta$	0.05%	0.05%
<b>Total</b>	<b><math>\delta P/P</math></b>	<b>0.36%</b>	<b>&lt;0.10%</b>

- I. Jay Benesch designed and is now working with Engineering to fabricate a more uniform and higher field dipole
- II. New Hall Probe: 0.01% accuracy, resolution to 2 ppm, and a temperature stability of 10 ppm/°C
- III. Better shielding of Earth's and other stray magnetic fields
- IV. Additional goal: Relative beam energy uncertainty **<0.02%**

# BREMSSTRAHLUNG BEAM

- Use both GEANT4 and FLUKA to calculate Bremsstrahlung spectra (we will not measure Bremsstrahlung spectra)
- Monte Carlo simulation of Bremsstrahlung at radiotherapy energies is well studied, accuracy:  $\pm 5\%$

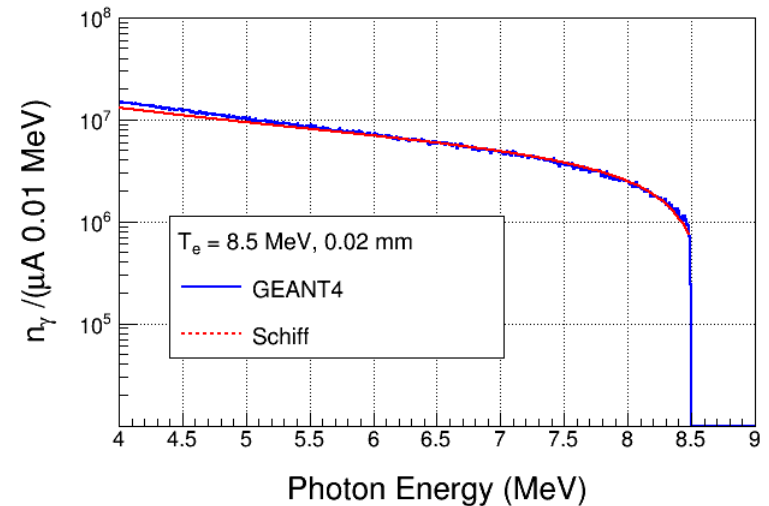

$^{16}\text{O}(\gamma, \alpha)^{12}\text{C}$  is ideal case for Bremsstrahlung beam and Penfold–Leiss Unfolding :

- Very steep; only photons near endpoint contribute to yield
- No-structure (resonances)

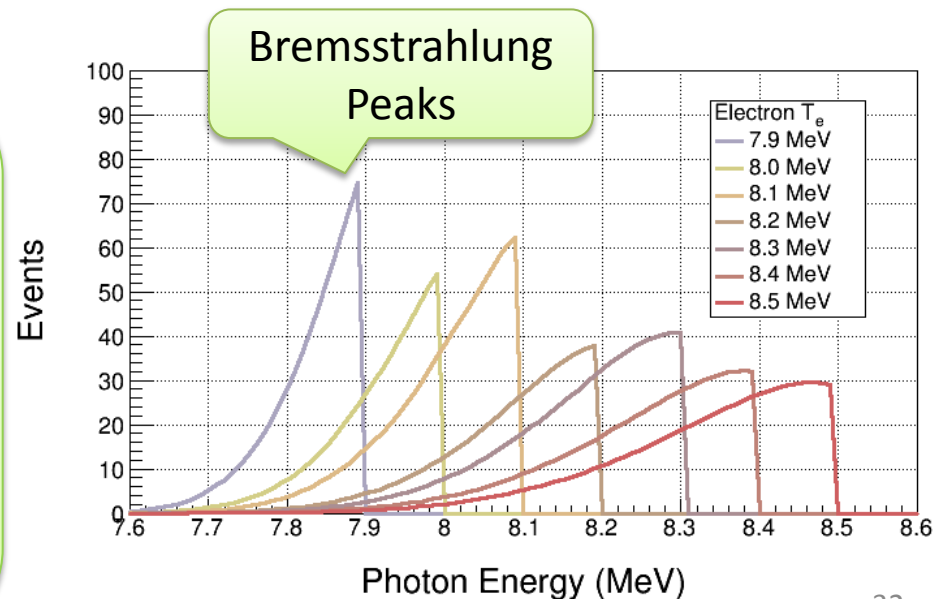

# GEANT4 SIMULATION

- Both GEANT4 and FLUKA use models that calculate wrong photo-nuclear cross sections. Both do not allow for user's cross sections. What to do?
  - I. Use GEANT4 and FLUKA to produce the photon spectra impinging on the superheated liquid.
  - II. Fold the above photon spectra with our cross sections in stand-alone codes.
- Use GEANT4 to design radiator, collimator, and dumps
- Geometry in GEANT4:

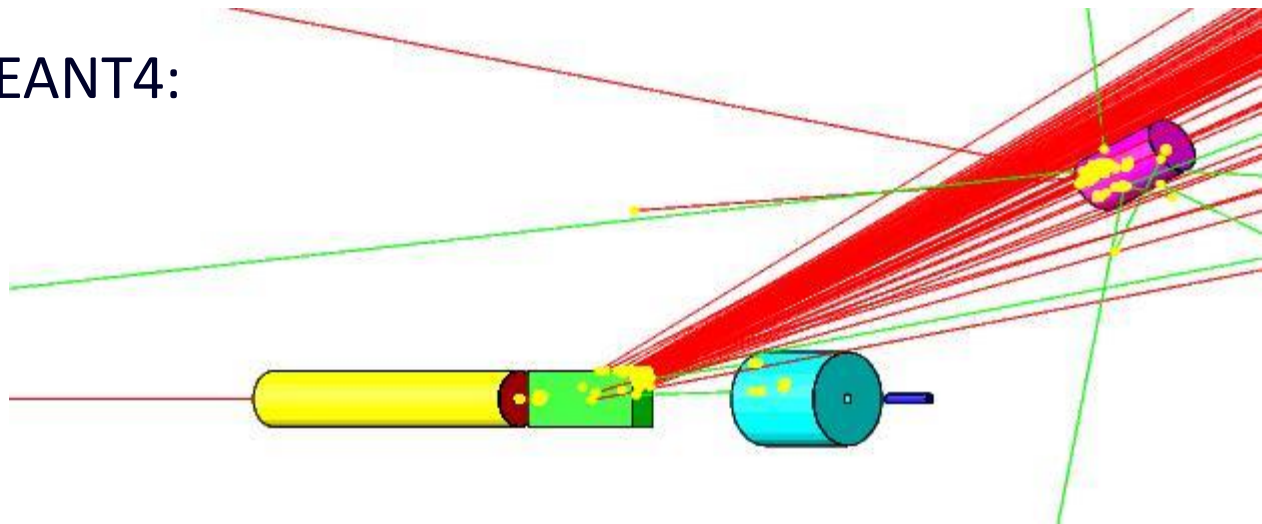

# PENFOLD-LEISS CROSS SECTION UNFOLDING

- Measure yields at:  $E = E_1, E_2, \dots, E_n$  where,  
 $E_i - E_{i-1} = \Delta, i = 2, n$

$$Y(E_i) = \int_{th}^{E_i} n_\gamma(E_i, k) \sigma(k) dk \approx \sum_{j=1}^i N_\gamma(E_i, \Delta, E_j) \sigma(E_j)$$

Volterra Integral Equation of First Kind

Method of Quadratures:  
 numerical solution of integral equation based on replacement of integral by finite sum

- The solution can be written in two forms:

$$\sigma_i = \frac{1}{N_{ii}} \left[ y_i - \sum_{j=1}^{i-1} (N_{ij} \sigma_j) \right]$$

- Or, Matrix form:

$$\begin{bmatrix} y_1 \\ y_2 \\ \vdots \\ y_n \end{bmatrix} = \begin{bmatrix} N_{\gamma,11} & 0 & \dots & 0 \\ N_{\gamma,21} & N_{\gamma,22} & \dots & 0 \\ \vdots & \ddots & \ddots & 0 \\ N_{\gamma,n1} & N_{\gamma,n2} & \dots & N_{\gamma,nn} \end{bmatrix} \begin{bmatrix} \sigma_1 \\ \sigma_2 \\ \vdots \\ \sigma_n \end{bmatrix}$$

$$[Y] = [N] \bullet [\sigma]$$

$$[\sigma] = [N]^{-1} \bullet [Y]$$

# STATISTICAL ERROR PROPAGATION

- Note:  $\frac{dy_i}{y_i} = \frac{1}{\sqrt{y_i}}$



$$dy_i = \sqrt{y_i}$$

$$dy_i = \sqrt{y_i + 2y_i^{bg}}$$

In case of  
background  
Subtraction

- With:

$$[B] = [N]^{-1}$$

$$[\sigma] = [B] \bullet [Y]$$

- Then:

$$[d\sigma^2] = [B] \bullet [dY^2] \bullet [B]^T$$

- Where:

$$[dY^2] = \begin{bmatrix} y_1 & 0 & \cdots & 0 \\ 0 & y_2 & \cdots & 0 \\ \vdots & \ddots & \ddots & \vdots \\ 0 & 0 & \cdots & y_n \end{bmatrix}$$

$$\begin{aligned} \text{var}(y_i, y_i) &= y_i \\ \text{cov}(y_i, y_j) &= 0 \end{aligned}$$

$$[d\sigma^2] = \begin{bmatrix} d\sigma_1^2 & \text{cov}(\sigma_1, \sigma_2) & \cdots & \text{cov}(\sigma_1, \sigma_n) \\ \text{cov}(\sigma_2, \sigma_1) & d\sigma_2^2 & \cdots & \text{cov}(\sigma_2, \sigma_n) \\ \vdots & \ddots & \ddots & \vdots \\ \text{cov}(\sigma_n, \sigma_1) & \text{cov}(\sigma_n, \sigma_2) & \cdots & d\sigma_n^2 \end{bmatrix}$$

Although,

$$\begin{aligned} \text{cov}(y_i, y_j) &= 0, \\ \text{cov}(\sigma_i, \sigma_j) &\neq 0 \end{aligned}$$

$$(d\sigma_i)^2 = \frac{1}{N_{ii}^2} \left[ dy_i^2 + \sum_{j=1}^{i-1} (N_{ij} d\sigma_j)^2 + \sum_{k=1}^{i-1} \sum_{l=1}^{i-1} N_{ik} \text{cov}(\sigma_k, \sigma_l) N_{il} \right]$$

For mono-chromatic  
photon beam

$$\left( \frac{d\sigma_i}{\sigma_i} \right)^2 = \left( \frac{dy_i}{y_i} \right)^2 = \frac{1}{y_i}$$



# RESULTS

- I. Radiator thickness = 0.02 mm
- II. Bubble Chamber thickness = 3.0 cm, number of  $^{16}\text{O}$  nuclei =  $3.474 \cdot 10^{22} / \text{cm}^2$
- III. Background subtraction of  $^{18}\text{O}(\gamma, \alpha)^{14}\text{C}$

$$[N] = \begin{bmatrix} 3.267e14 & 0 & 0 & 0 & 0 & 0 & 0 \\ 9.782e13 & 6.439e13 & 0 & 0 & 0 & 0 & 0 \\ 5.013e13 & 3.858e13 & 2.539e13 & 0 & 0 & 0 & 0 \\ 1.494e13 & 1.236e13 & 9.514e12 & 6.258e12 & 0 & 0 & 0 \\ 8.540e12 & 7.369e12 & 6.097e12 & 4.692e12 & 3.086e12 & 0 & 0 \\ 3.801e12 & 3.370e12 & 2.908e12 & 2.406e12 & 1.852e12 & 1.217e12 & 0 \\ 2.075e12 & 1.875e12 & 1.663e12 & 1.435e12 & 1.187e12 & 9.137e11 & 6.004e11 \end{bmatrix}$$

Electron Beam K. E.	Beam Current ( $\mu\text{A}$ )	Time (hour)	$y_i$	$dy_i$ (no bg)	$dy_i/y_i$ (no bg, %)	$dy_i$ (with bg)	$dy_i/y_i$ (with bg, %)
7.9	100	100	545	23	4.2	134	24.6
8.0	100	20	581	24	4.1	77	13.3
8.1	80	10	852	29	3.4	60	7.0
8.2	20	10	634	25	3.9	40	6.3
8.3	10	10	812	28	3.4	39	4.8
8.4	4	10	746	27	3.6	36	4.8
8.5	2	10	763	28	3.7	32	4.2

# SYSTEMATIC ERROR PROPAGATION

- For absolute beam energy uncertainty of  $\delta E$  (= 0.1%) and zero relative beam energy uncertainty:

$$\frac{dy_i}{y_i} = \frac{y_i(E_i + \delta E) - y_i(E_i)}{y_i(E_i)}$$

$$\frac{dN_{ij}}{N_{ij}} = \frac{N_{ij}(E_i + \delta E) - N_{ij}(E_i)}{N_{ij}(E_i)}$$

$$E_0 = 7.8 + \delta E$$

$$E_i = E_0 + i\Delta$$

$E_i$ (MeV)	$dy_i/y_i$ (%)	$d\sigma_i/\sigma_i$ (%)
7.9	12.5	12.6
8.0	10.8	10.5
8.1	9.3	9.1
8.2	8.0	7.1
8.3	7.0	6.3
8.4	6.3	5.8
8.5	5.6	5.2

This is the cross section dependence on energy

- Accounted for  $dN_{ij}$  due to energy error when calculating  $dy_i$

$$\approx \frac{\delta E}{i\Delta}$$

$$\left[ \frac{dN_{ij}}{N_{ij}} \right] = \begin{bmatrix} 0.100 & 0 & 0 & 0 & 0 & 0 & 0 \\ 0.058 & 0.050 & 0 & 0 & 0 & 0 & 0 \\ 0.041 & 0.039 & 0.033 & 0 & 0 & 0 & 0 \\ 0.031 & 0.031 & 0.029 & 0.025 & 0 & 0 & 0 \\ 0.025 & 0.025 & 0.025 & 0.023 & 0.020 & 0 & 0 \\ 0.021 & 0.021 & 0.021 & 0.021 & 0.020 & 0.017 & 0 \\ 0.018 & 0.018 & 0.018 & 0.018 & 0.018 & 0.017 & 0.022 \end{bmatrix}$$

- With:

$$[B] = [N]^{-1}$$

$$[\sigma] = [B] \bullet [Y]$$

- Then:

$$[d\sigma^2] = [B] \bullet \left( [dY^2] + [dN^2] \bullet [\sigma^2] \right) \bullet [B]^T$$

- Where:

Note: Correlation Coefficient ( $\rho_{ij}$ ) = 1

$$\text{var}(y_i, y_i) = (dy_i)^2$$

$$\text{cov}(y_i, y_j) = \rho_{ij} dy_i dy_j$$

$$[dY^2] = \begin{bmatrix} (dy_1)^2 & dy_1 dy_2 & \cdots & dy_1 dy_n \\ dy_2 dy_1 & (dy_2)^2 & \cdots & dy_n dy_n \\ \vdots & \ddots & \ddots & \vdots \\ dy_n dy_1 & dy_n dy_2 & \cdots & (dy_n)^2 \end{bmatrix}$$

No energy-to-energy change in systematic error

$$[d\sigma^2] = \begin{bmatrix} d\sigma_1^2 & \text{cov}(\sigma_1, \sigma_2) & \cdots & \text{cov}(\sigma_1, \sigma_n) \\ \text{cov}(\sigma_2, \sigma_1) & d\sigma_2^2 & \cdots & \text{cov}(\sigma_2, \sigma_n) \\ \vdots & \ddots & \ddots & \vdots \\ \text{cov}(\sigma_n, \sigma_1) & \text{cov}(\sigma_n, \sigma_2) & \cdots & d\sigma_n^2 \end{bmatrix}$$

$$[dN^2] = \begin{bmatrix} (dN_{11})^2 & 0 & \cdots & 0 \\ (dN_{21})^2 & (dN_{22})^2 & \cdots & 0 \\ \vdots & \ddots & \ddots & \vdots \\ (dN_{n1})^2 & (dN_{n2})^2 & \cdots & (dN_{nn})^2 \end{bmatrix}$$

$$[\sigma^2] = \begin{bmatrix} \sigma_1^2 & 0 & \cdots & 0 \\ 0 & \sigma_2^2 & \cdots & 0 \\ \vdots & \ddots & \ddots & \vdots \\ 0 & 0 & \cdots & \sigma_n^2 \end{bmatrix}$$

# SYSTEMATIC ERROR PROPAGATION

No energy-to-energy change in systematic error

$$\begin{aligned}
 (d\sigma_i)^2 \cong & \frac{1}{N_{ii}^2} \left[ dy_i^2 - 2dy_i \sum_{j=1}^{i-1} N_{ij} d\sigma_j \right. \\
 & + \sum_{j=1}^{i-1} (N_{ij} d\sigma_j)^2 + \sum_{k=1}^{i-1} \sum_{l=1}^{i-1} N_{ik} \text{cov}(\sigma_k, \sigma_l) N_{il} \\
 & \left. + \sum_{j=1}^{i-1} (dN_{ij} \sigma_j)^2 + (dN_{ii} \sigma_i)^2 \right]
 \end{aligned}$$

$\text{cov}(y_i, y_j) \neq 0,$   
 $\text{cov}(\sigma_i, \sigma_j) \neq 0$



# OTHER SYSTEMATIC ERRORS

Beam Current, $\delta I/I$	3%
Photon Flux, $\delta\phi/\phi$	5%
Radiator Thickness, $\delta R/R$	3%
Bubble Chamber Thickness, $\delta T/T$	3%
Bubble Chamber Efficiency, $\varepsilon$	5%

Simulation

- Then:

$$(dy_i)^2 = (dy_i(\delta E))^2 + \left[ \left( \frac{\delta I}{I} \right)^2 + \left( \frac{\delta R}{R} \right)^2 + \left( \frac{\delta T}{T} \right)^2 + \varepsilon^2 \right] y_i^2$$

$$(dN_{ij})^2 = \left( \frac{\delta\phi}{\phi} \right)^2 N_{ij}^2$$

Electron Beam K. E.	Cross Section (nb)	Stat Error (no bg, %)	Stat Error (with bg, %)
7.9	0.046	4.4	24.5
8.0	0.185	6.0	20.7
8.1	0.58	6.3	14.7
8.2	1.53	8.2	13.8
8.3	3.49	9.1	13.3
8.4	7.2	10.6	13.8
8.5	13.6	12.2	14.8

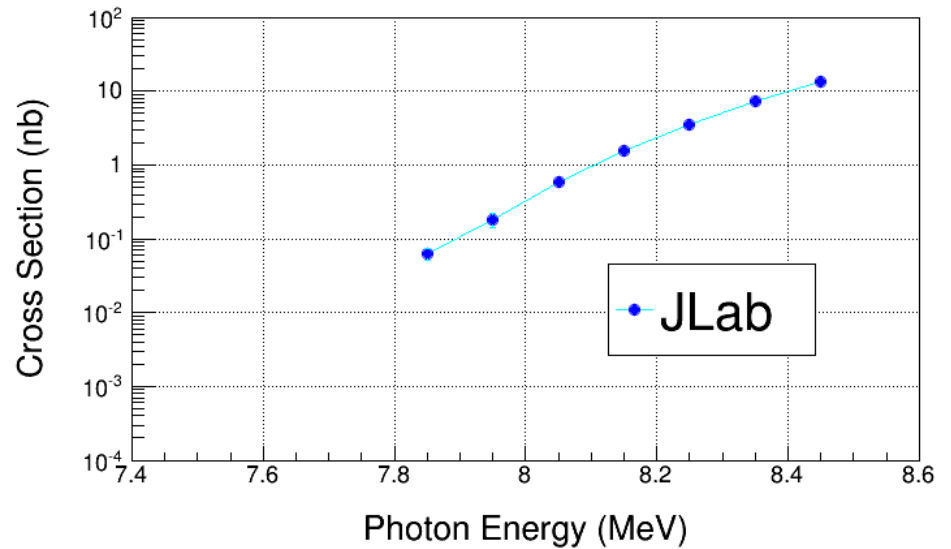

Electron Beam K. E.	Cross Section (nb)	Sys Error (Energy, %)	Sys Error (Total, %)
7.9	0.046	12.5	15.3
8.0	0.185	10.2	13.5
8.1	0.58	8.3	12.2
8.2	1.53	7.0	11.4
8.3	3.49	6.0	10.7
8.4	7.2	5.3	10.5
8.5	13.6	4.7	10.1

**Note:** Absolute systematic errors do not get magnified in PL Unfolding

# JLAB PROJECTED $^{12}\text{C}(\alpha,\gamma)^{16}\text{O}$ S-Factor

- Statistical Error: dominated by background subtraction from  $^{18}\text{O}(\gamma,\alpha)^{14}\text{C}$  (depletion = 5,000)

Electron Beam K. E.	Gamma Energy (MeV)	$E_{CM}$ (MeV)	Cross Section (nb)	$S_{tot}$ Factor (keV b)	Stat Error (%)	Sys Error (Total, %)
7.9	7.85	0.69	0.046	62.2	24.5	15.3
8.0	7.95	0.79	0.185	48.7	20.7	13.5
8.1	8.05	0.89	0.58	41.8	14.7	12.2
8.2	8.15	0.99	1.53	35.5	13.8	11.4
8.3	8.25	1.09	3.49	32.0	13.3	10.7
8.4	8.35	1.19	7.2	28.8	13.8	10.5
8.5	8.45	1.29	13.6	26.3	14.8	10.1

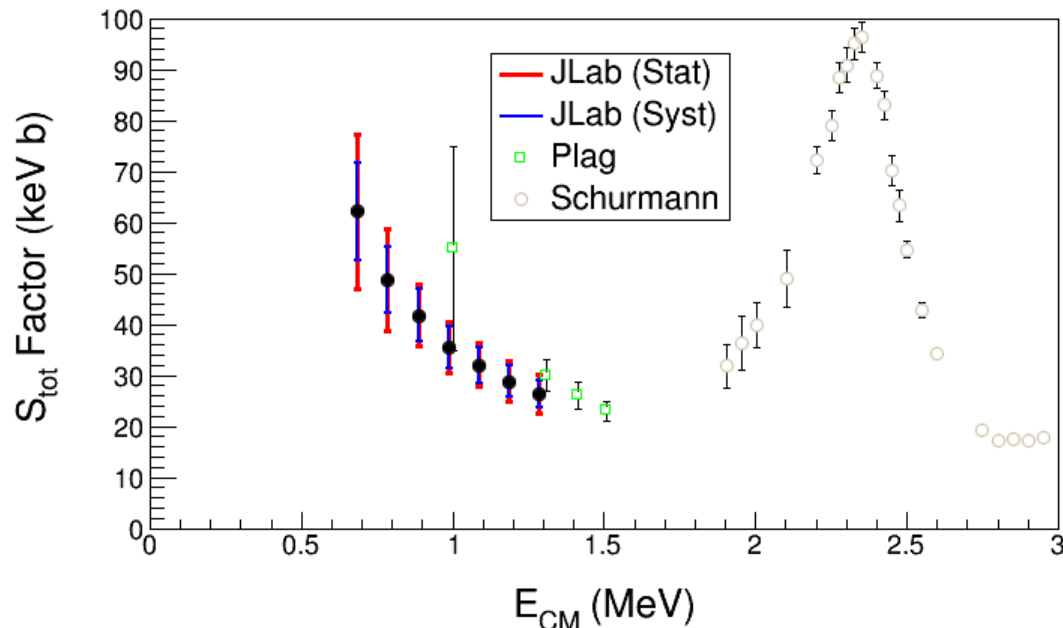

Bubble Chamber experiment measures total S-Factor,  $S_{E1} + S_{E2}$

# BACKGROUNDS

## I. Background from oxygen isotopes and nitrogen in N<sub>2</sub>O:

- $^{18}\text{O}(\gamma, \alpha)^{14}\text{C}$
- $^{17}\text{O}(\gamma, \alpha)^{13}\text{C}$
- $^{14}\text{N}(\gamma, p)^{13}\text{C}$

### ➤ Natural Abundance:

- I.  $^{17}\text{O}$ : 0.038%
- II.  $^{18}\text{O}$ : 0.205%

### ➤ Expected Rates:

- I.  $^{17}\text{O}(\gamma, \alpha)^{13}\text{C}$ , depletion=5,000
- II.  $^{18}\text{O}(\gamma, \alpha)^{14}\text{C}$ , depletion=5,000
- III.  $^{14}\text{N}(\gamma, p)^{13}\text{C}$ , Chamber eff.=  $10^{-8}$

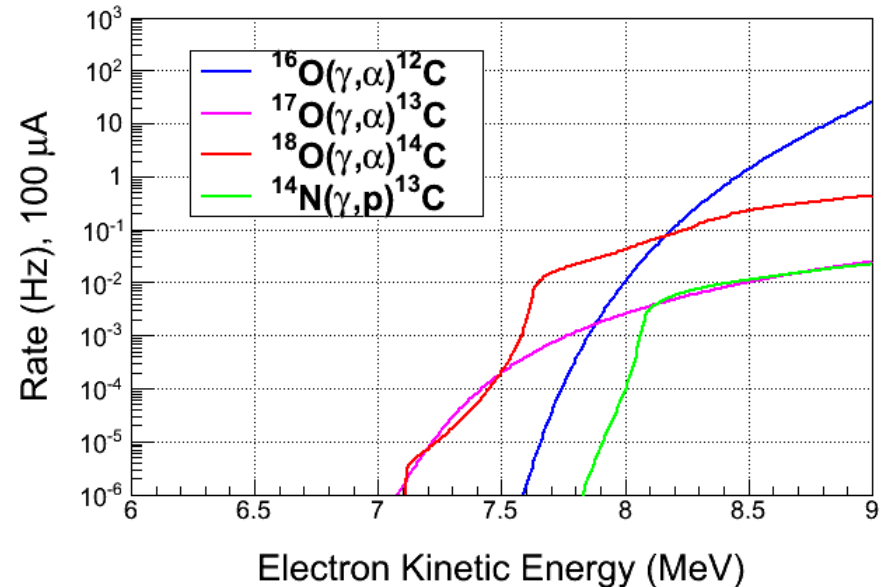
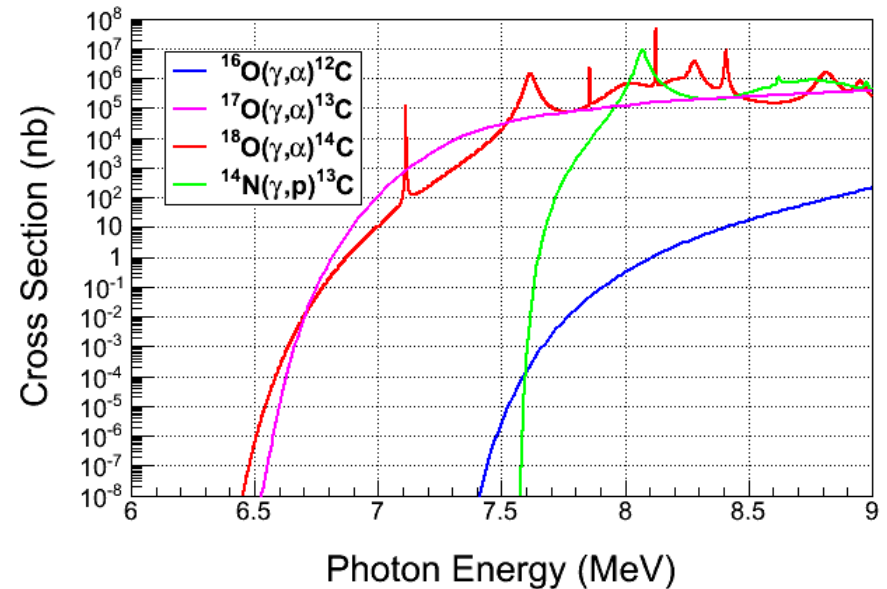

II. Background from:

- $^{17}\text{O}(\gamma,n)^{16}\text{O}$  and secondary (n,n) neutron-nucleus elastic scattering

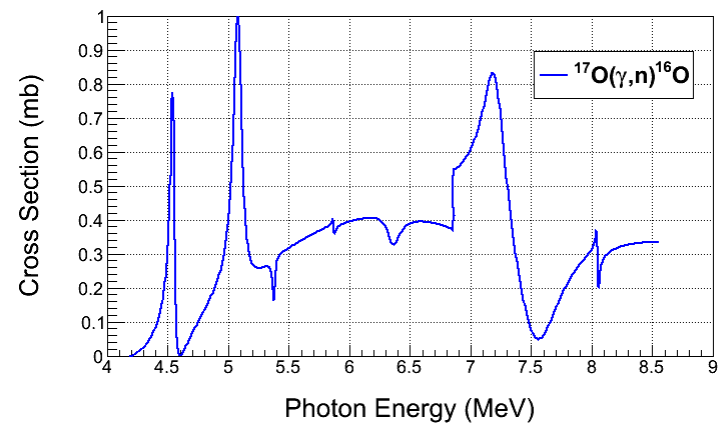

III. Background from Chamber glass:

- Neutron-nucleus elastic scattering from  $^{29}\text{Si}(\gamma,n)^{28}\text{Si}$

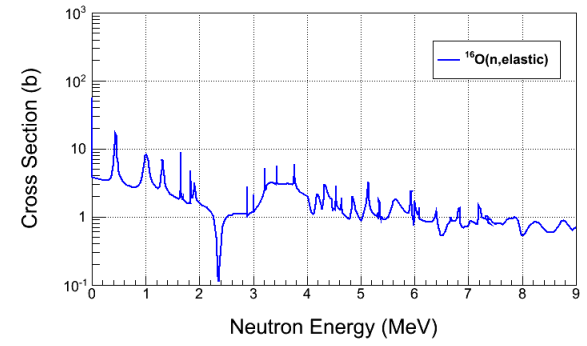

IV. Cosmic-ray background:

- $\mu^\pm$ -nuclear
- neutron-nuclear elastic scattering

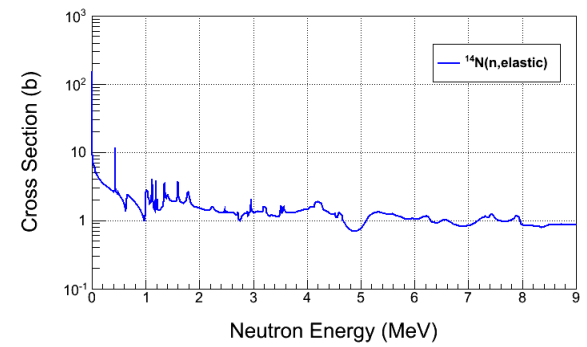

➤ Reject neutron events using acoustic signal (100 suppression factor)

# ION ENERGY DISTRIBUTIONS

➤ Use depleted N<sub>2</sub>O:

- I. <sup>17</sup>O depletion = 5,000
- II. <sup>18</sup>O depletion = 5,000

➤ Suppress background with Bubble Chamber thresholds

$$E_{CM} \cong E_{\gamma} - Q$$

$$E_{CM} = T_{\alpha} + T_C$$

$$T_{\alpha,lab} \cong \frac{m_c}{m_{\alpha} + m_c} E_{CM}$$

$$T_{C,lab} \cong \frac{m_{\alpha}}{m_{\alpha} + m_c} E_{CM}$$

➤ Threshold Efficiency (function of superheat):

Particle	Efficiency
e <sup>±</sup>	<10 <sup>-11</sup>
γ	<10 <sup>-11</sup>
<sup>14</sup> N(γ,p) <sup>13</sup> C	<10 <sup>-8</sup>

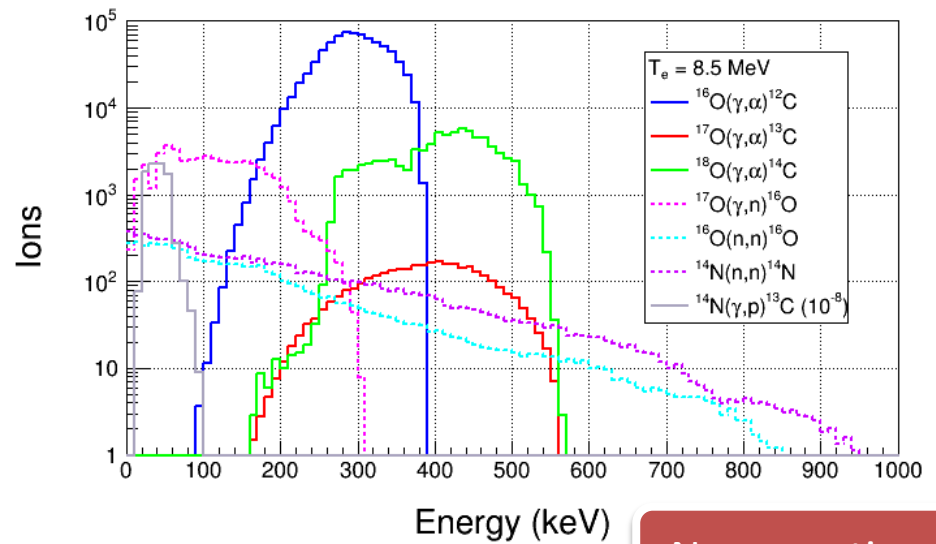

No acoustic cut

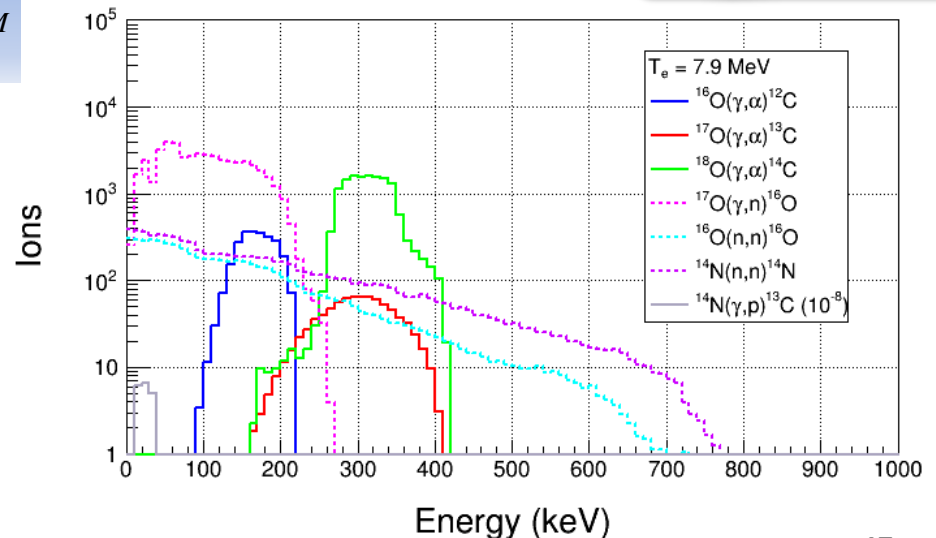



# SUPERHEATED TARGETS

I. List of superheated liquids to be used in experiment:

	N <sub>2</sub> O Targets	<sup>16</sup> O	<sup>17</sup> O	<sup>18</sup> O
	Natural Target	99.757%	0.038%	0.205%
Physics	<sup>16</sup> O Target		Depleted > 5,000	Depleted > 5,000
	<sup>17</sup> O Target		Enriched > 80%	<1.0%
Measure Backgrounds	<sup>18</sup> O Target		<1.0%	Enriched > 80%

II. Readout:

- I. Fast Digital Camera
- II. Acoustic Signal to discriminate between neutron and alpha events

# SUMMARY AND OUTLOOK

- Test N<sub>2</sub>O Bubble Chamber at HIGS (Summer 2014)
- Measure cross sections of  $^{18}\text{O}(\gamma,\alpha)^{14}\text{C}$  and  $^{17}\text{O}(\gamma,\alpha)^{13}\text{C}$  at HIGS (Fall 2014)
- Test Bubble Chamber at JLab (October 2014, January 2015)
- Run depleted N<sub>2</sub>O bubble chamber at JLab to measure  $^{16}\text{O}(\gamma,\alpha)^{12}\text{C}$
- Beam issues:
  - Design radiator, collimator, and dumps with GEANT4
  - Simulate photon spectra with GEANT4 and FLUKA
  - Deliver 8.5 MeV K.E. beam to 5D Spectrometer with <0.1% absolute energy uncertainty
- Bubble Chamber issues:
  - Study acoustic signal and measure neutron events suppression factor
  - Deadtime measurements: use laser shutter to stop beam while chamber is not ready
  - Measure O-isotopes depletion
- Background tests:
  - Measure cosmic-ray background
  - Study chamber thresholds efficiency vs. superheat and measure  $\gamma$ -rays suppression factor

# BACKUP SLIDES

# CO<sub>2</sub> SUPERHEATED LIQUID?

- Similar Bubble Chamber operational parameters as N<sub>2</sub>O
- Natural Abundance: <sup>13</sup>C: 1.07%
- Depletion: <sup>13</sup>C depletion=1,000
- <sup>13</sup>C(γ,n)<sup>12</sup>C Background

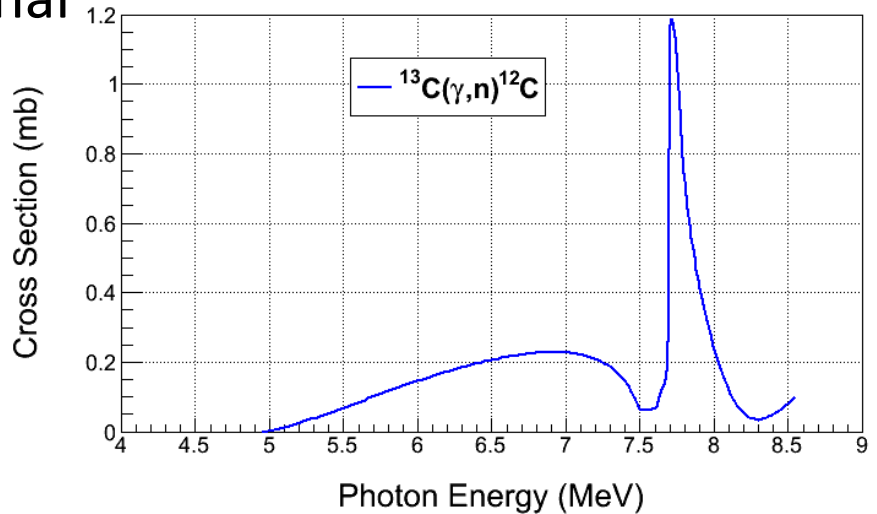

For comparison, <sup>17</sup>O(γ,n)<sup>16</sup>O

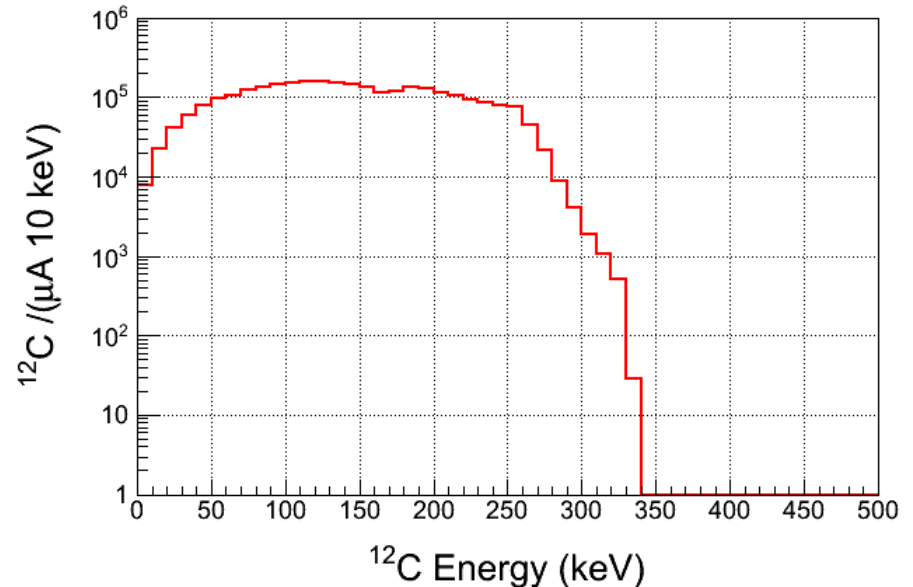
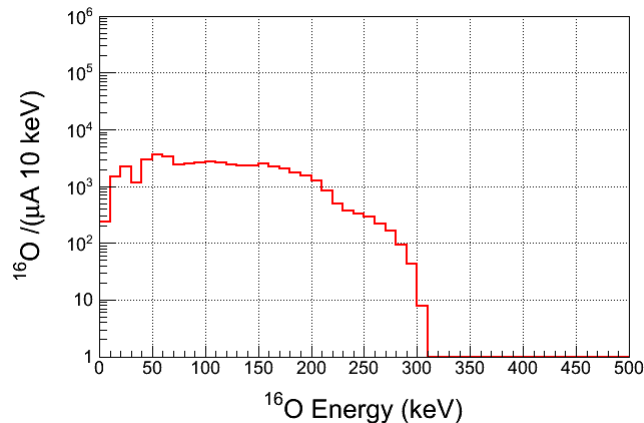

- <sup>12</sup>C(γ,2α)α Background

# WATER SUPERHEATED LIQUID?

- Etching of glass vessel by superheated H<sub>2</sub>O
  - T = 250°C
  - P = 75 atm
- Background from secondary neutron–nucleus elastic scattering by neutrons from  $d(\gamma,n)p$

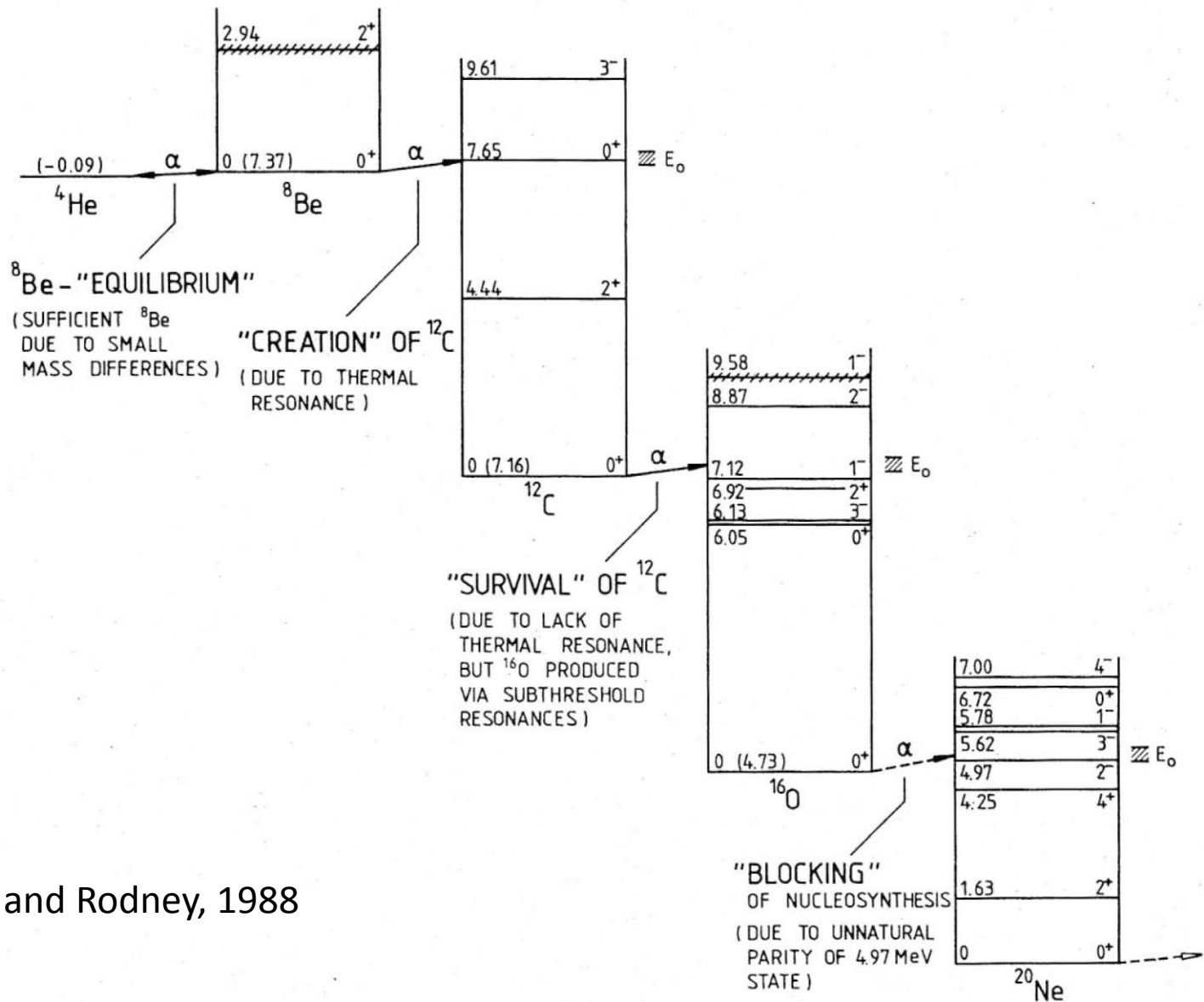

Rolfs and Rodney, 1988