

Bubble Chamber Detector System

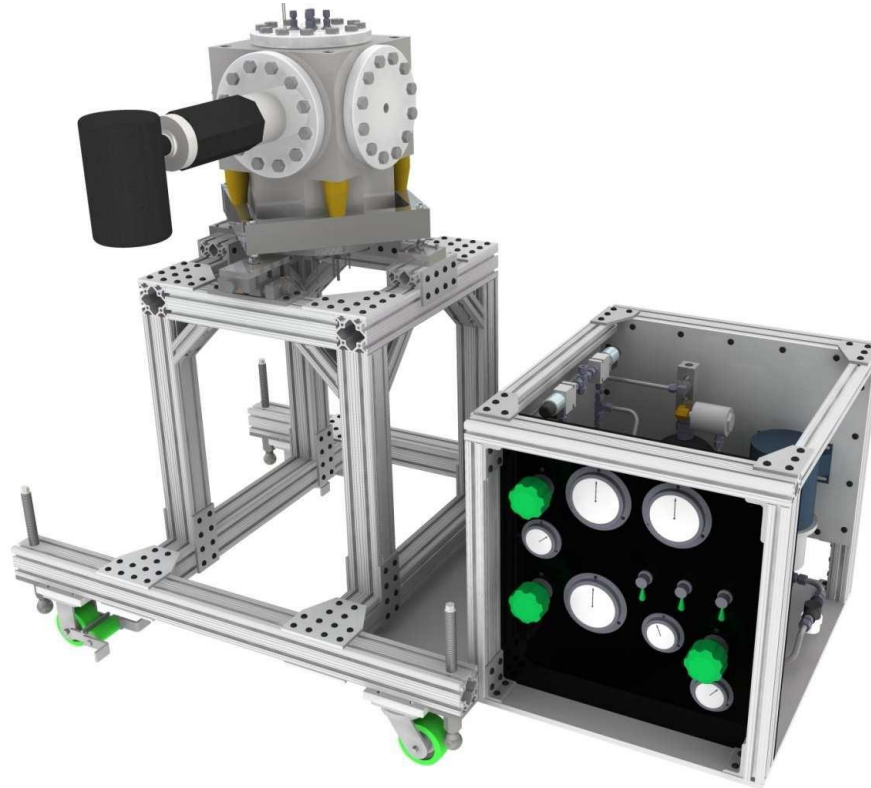

ANL Bubble Chamber

- Lead designer and fabricator Brad DiGiovine (ANL)
- April 2009 Chamber Received Full Operation Authorization for (C₄F₁₀)
- February 2010 First Bubble Chamber Received Upgrade Authorization for Superheated H₂O
- Two runs at HI γ S
- Modifications: N₂O with Hg as buffer fluid
- Modifications were reviewed at ANL
- Extensive testing and operations ANL using N₂O and mercury (neutron source)
- Brought to JLAB for testing with photons
 - JLAB Design Authority: Dave Meekins
 - First user built pressure system (non-vacuum) post 10 CFR 851

Theory of Operation

1 Cell is cooled then filled with room temperature gas

2 Gas is cooled and condenses into liquid

3 Once cell is completely filled with liquid, pressure is reduced creating a superheated liquid

3 Nuclear reactions induce bubble nucleation

2 High speed camera detects bubble and repressurizes

3 System depressurizes and ready for another cycle

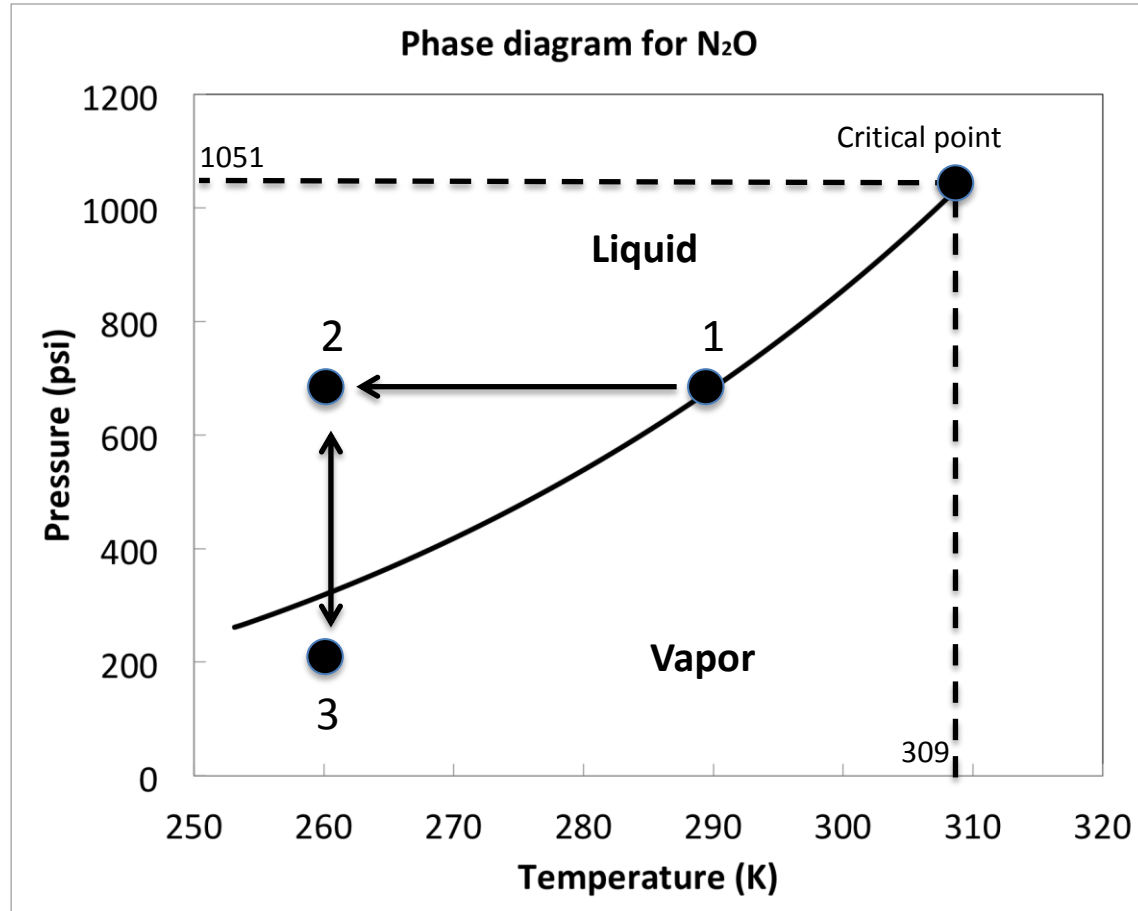

BUBBLE GROWTH AND QUENCHING

100 Hz Digital Camera

$\Delta t = 10 \text{ ms}$

N_2O Chamber
with PuC neutron
source

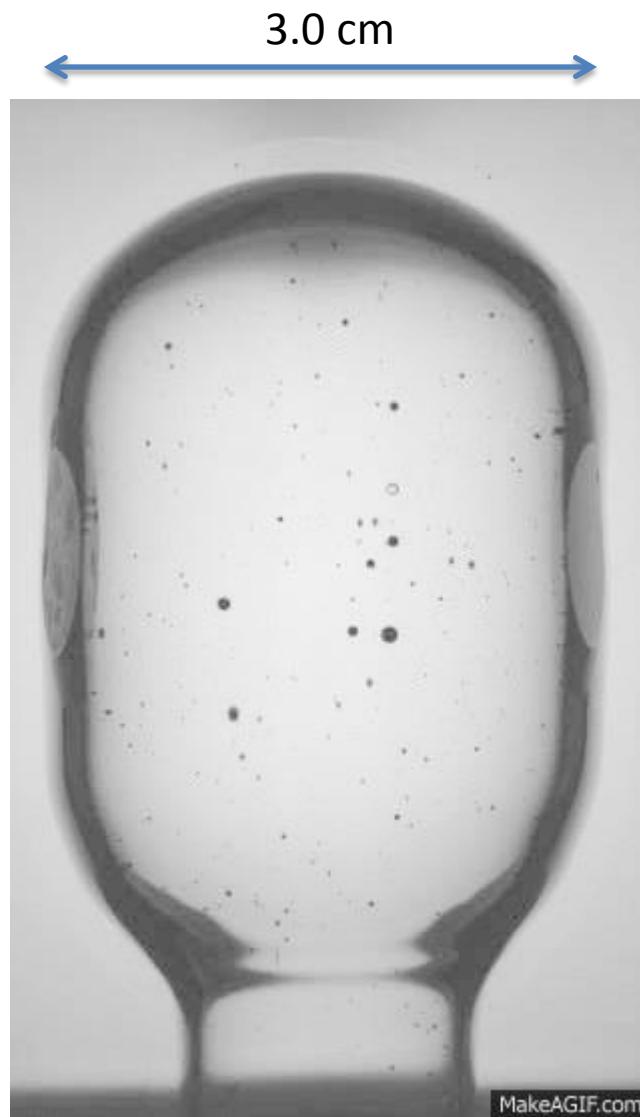

Systems and Components

- Bubble Chamber
 - 40-60 ml
- Pressure Vessel
 - Max operating pressure 1000 psi
- Viewport, Camera and Lighting
- Hydraulic Control
- Cooling circuit/refrigerator
 - -20C to room temp.
- DAQ/Control and Instrumentation

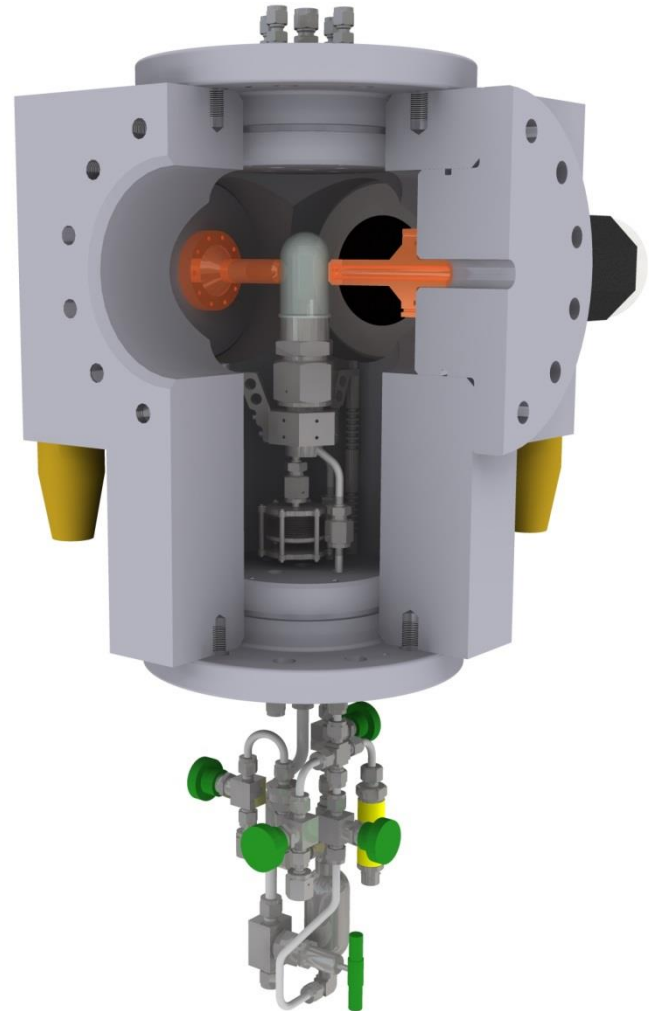

Basic Components

- Heavy Wall Stainless Steel Pressure Vessel
- Thin Wall Glass Active Liquid Volume
- Thin Pressure Transfer Bellows
- Cooling Coils
- Pressure Supply
- Solenoid Valves
- High Speed Camera

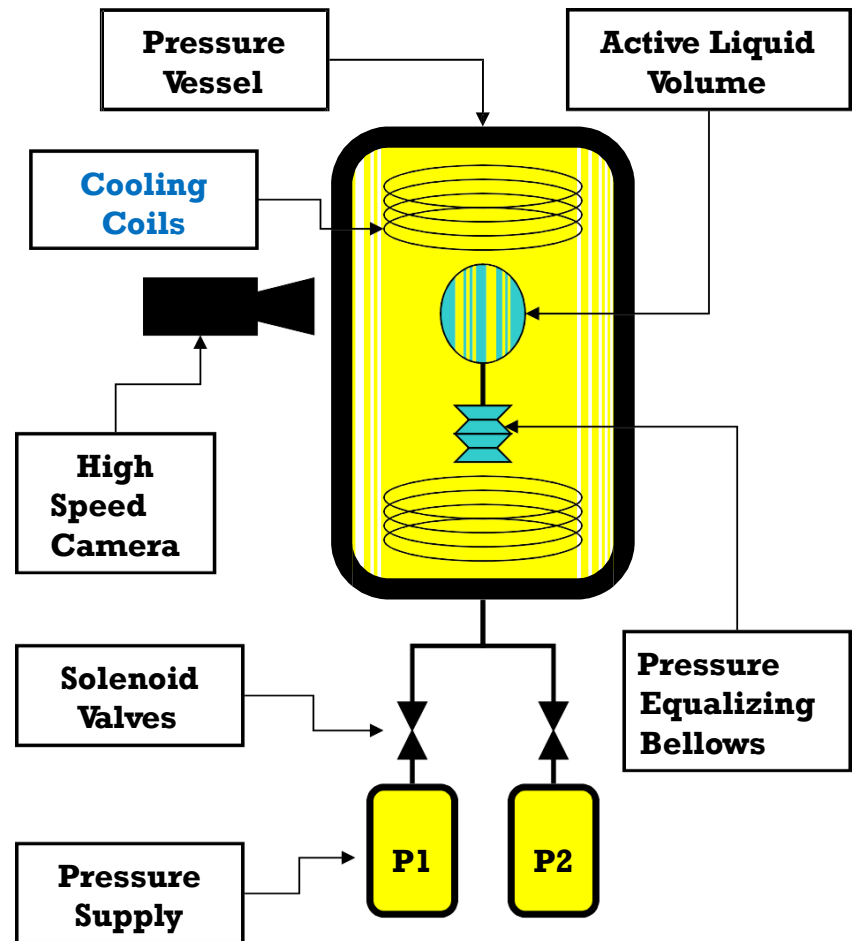

Bubble Chamber

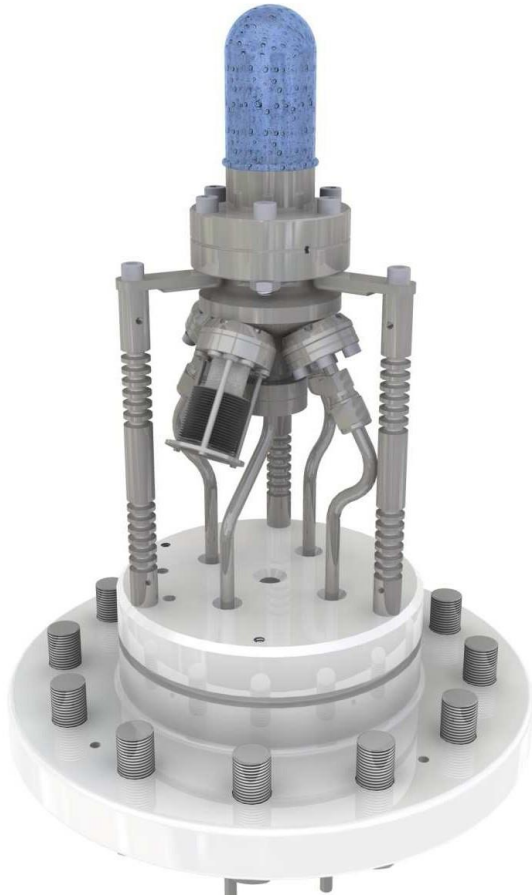

- Thin Glass Vessel Holds Active Liquid, N_2O
- N_2O 40-60 ml Floats on Mercury 150 ml, Which Fills Remaining Inner Volume
- Superheated Liquid Only in Contact With Smooth Surfaces
- Thin Sensitive Edge Welded Bellows Equalize Pressure
- Stainless Tube Facilitates External Connection of Pressure Transducers and Filling Valves
- Wetted Materials: Stainless Steel, Kovar, Glass
- Copper cooling coils (not shown) supplied by commercial refrigerator.

Pressure Vessel

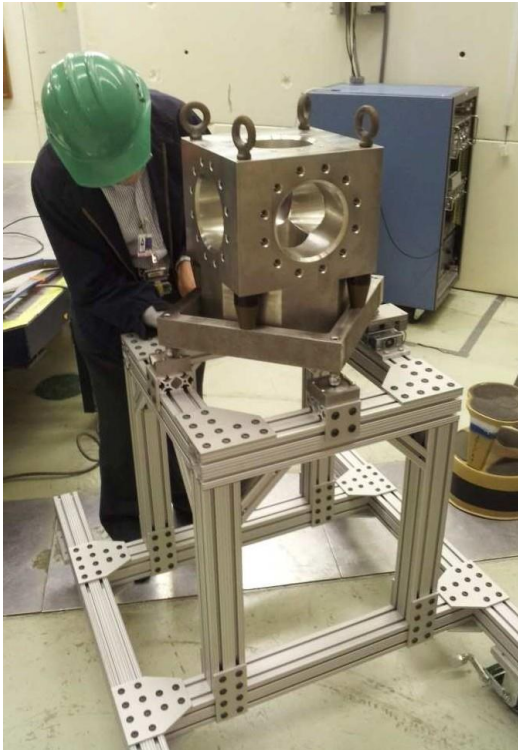

- Houses Bubble Chamber
- One Piece Construction
 - No Welding
 - Minimal Internal Volume
- Machined From a Solid 304 S.S. Forging
- Flanges Machined From 316 S.S.
 - Utilize a Plug Design to Reduce Inner Volume
- Maximum allowable design pressure 1700 psi.
 - Component has 5.75" bore
 - Treated as B31.3 (using 304.7.2)
 - Div 2 analysis using elastic plastic
 - Plastic collapse/local failure
 - Fatigue screening indicates cycles required to squish bubbles not deep enough to consider for 500 psi ΔP maximum. Div 2 Part 5.5.2.4

Viewport, Camera, and Lighting

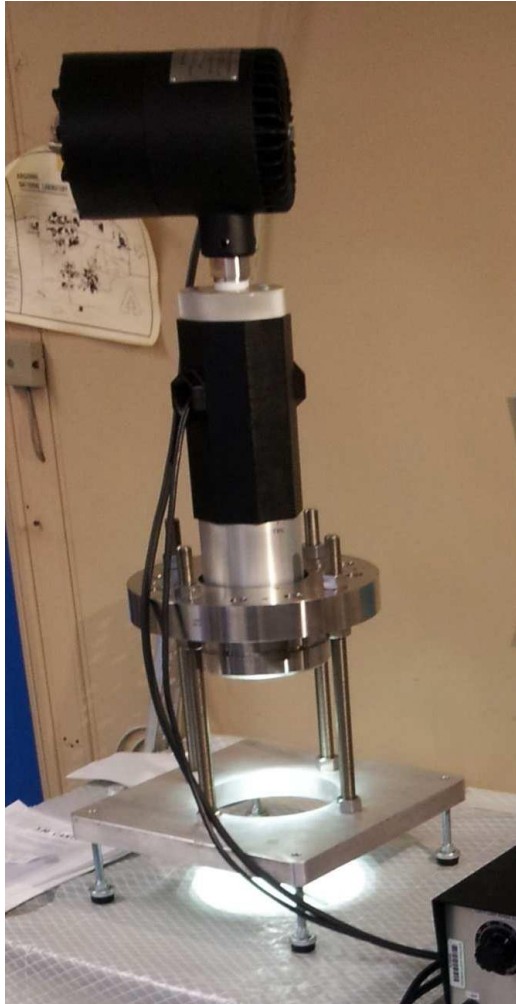

- Two Custom Designed and Fabricated by Industry Leader in High P&T Viewports
- Design Parameters:
 - 260°C Operating temperature
 - 88 ATM (1300 psi) Operating pressure
- One Houses High Speed 100FPS Camera
- One Houses High Intensity LED Back Lighting

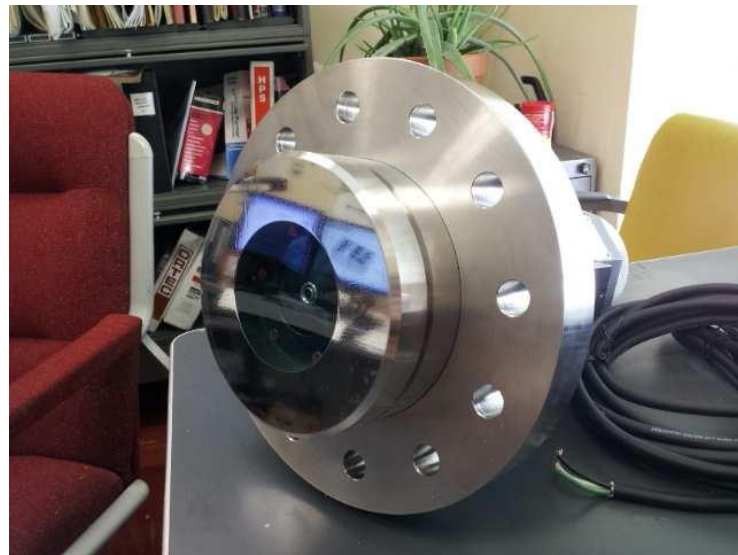

Hydraulic Control System

- Constructed of standard fittings and components with minimum working ratings of 1500 psi.
- Piping is SST tube and flex lines with lowest design P=2500 psi
- Accumulators are charged with N2 circuit design P=1000 psi
- Pump supplies 1 gpm
- Multiple hydraulic regulators and reliefs
- Vented reservoir
- Screened for cyclic loading



Hydraulic Control System

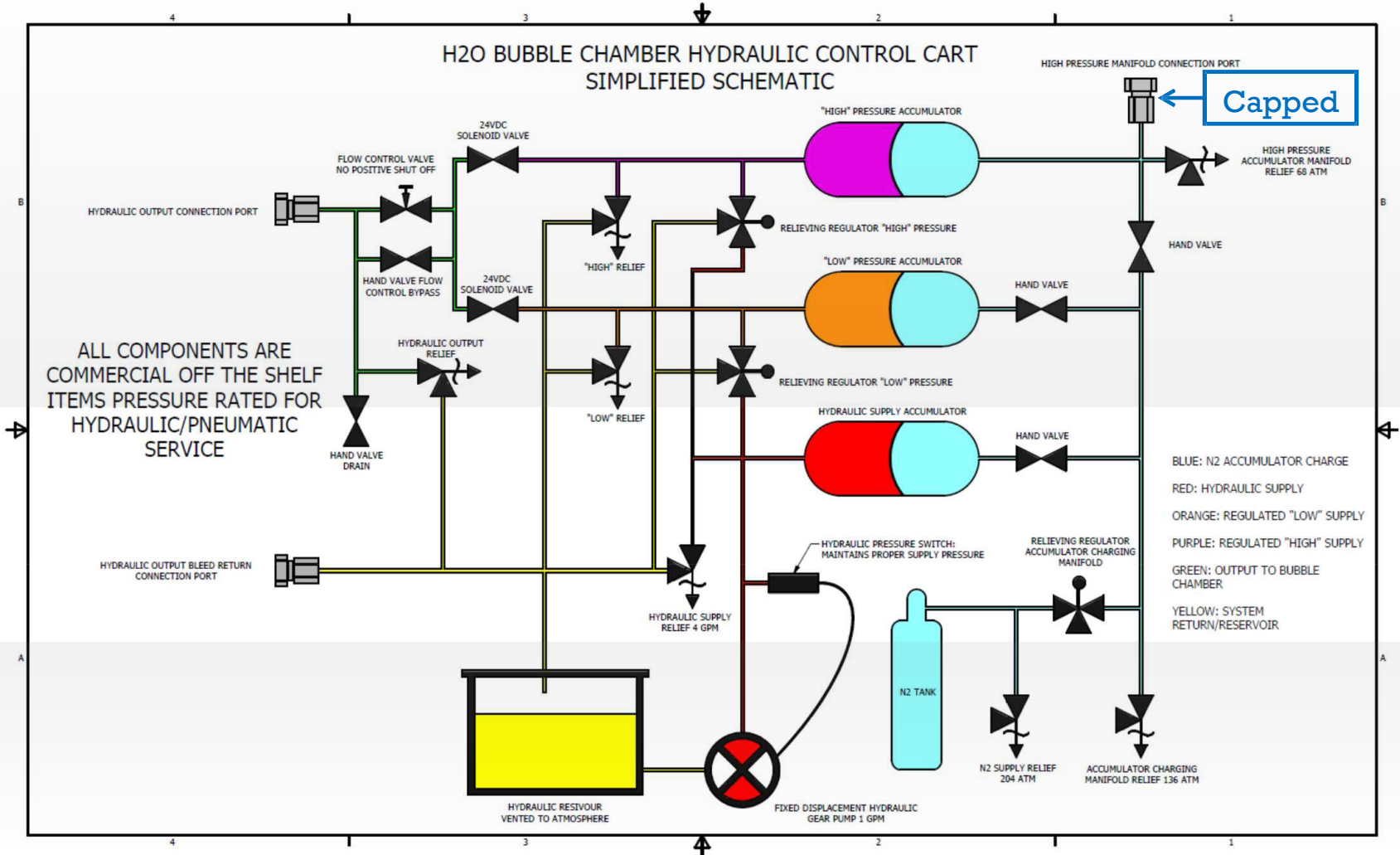

Overpressure Protection

- Two separate circuits
- Sources of overpressure
 - Fire (not considered)
 - Pump run away
- N2 circuit
 - ASME relief directly on bottle
 - Orifice restricted flow to system piping
 - 1000 psi ASME relief with adequate flow capacity
- Hydraulic circuit
 - Multiple hydraulic reliefs non ASME below 1000 psi.
 - ASME relief on chamber 1100 psi (12.7 gpm)
 - N2O is liquid at room temp at this pressure
- Detailed in TGT-CALC-502-003

HazMat

- Two materials of note:
 - Mercury (Hg)
 - Nitrous Oxide (N₂O)
- Admin and Eng controls in place
 - Procedures for filling/operating/venting
 - Hg not “handled” at JLAB under normal conditions
 - Volume of N₂O in chamber is 17 liters at STP
 - Filters are in place to prevent Hg liquid and vapor from escaping confinement.

Mercury

- Prolonged or intense acute exposure can be very hazardous.
- Active fluid is removed through
 - Phase separator
 - Droplet Filter
 - Vapor Filter
- This prevents Hg from escape.
- There is secondary containment under the chamber should a mistake occur
 - Two step error: Removing VCR Cap and opening valve
- Monitor personnel for exposure using SKC Elemental Mercury Passive Sampler.
- IH to monitor filling/venting
- Filling and venting procedures shall only be performed by Brad DiGiovine (ANL).
- Spill kit on hand to properly respond in the event of containment loss

N2O

- Occupational exposure limit of 50 ppm
 - 2000 hr/year
- If all in chamber is released to injector -> 25 ppm
- Monitor personnel for exposure using Assay Technology 575 N2O sampler.
- IH to monitor filling/venting
- Filling and venting procedures shall only be performed by Brad DiGiovine (ANL).
- Supply bottle is removed immediately after fill procedure is complete. (Total of 17 STPL in injector)

Electrical Safety

- System requires 208VAC power
- Custom components were developed by ANL
 - Detailed schematics can be found in pressure systems folder
 - The system was inspected by both ANL and JLAB
- All components can be disconnected from the power source with plug and secured.

Cooling

- Heavy Wall Copper Cooling Coils Installed
- Bath Operating Temperature -20C to 20C

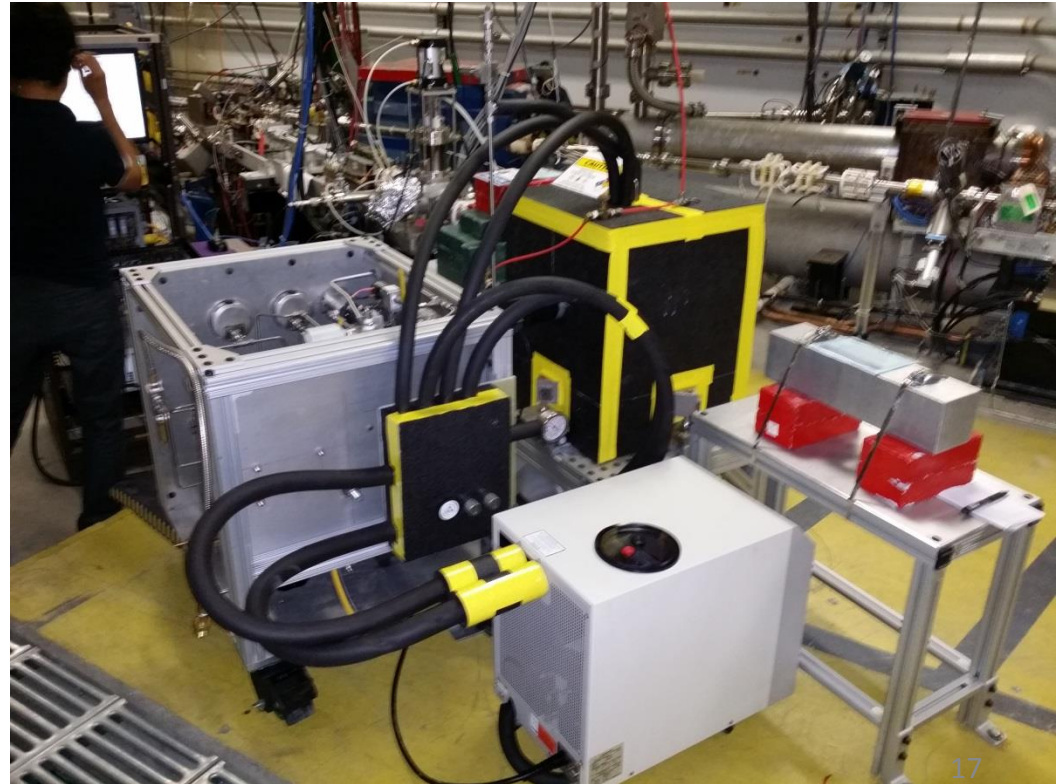

Control and Instrumentation Chassis

- Temperature Monitoring and Heater Control
- Pressure and Temperature Transducer Retransmission to Computer
- Solenoid Valve Manual Operation and Computer Interface
- Hydraulic System Logic and Interlocks
- Two Remote Override Control Interfaces
- Electrical Safety Inspection Completed on All Chasses

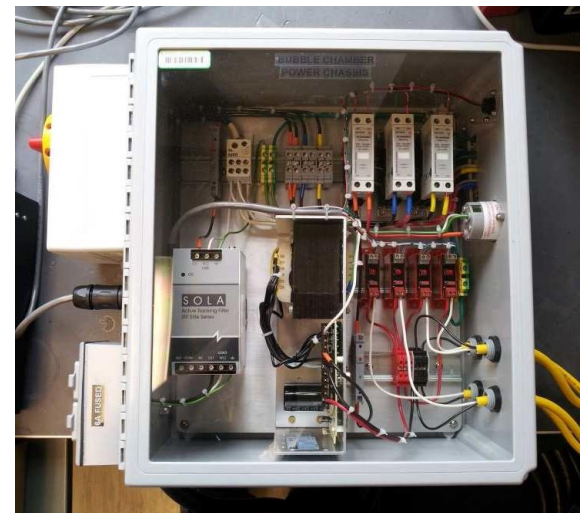

Control Chassis & Remote Overrides

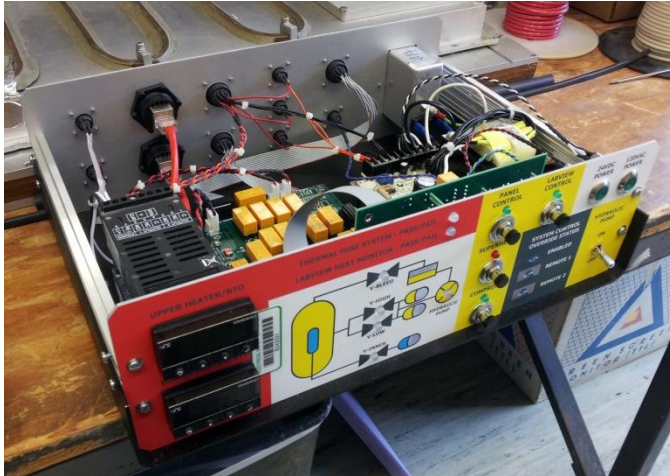

- Control Chassis Designed with Safety Interlocks
 - Heating
 - Solenoid Valves



- Two Remote Override Interfaces Allow for Complete Control of System
 - Solenoid Valves
 - Hydraulic Pump
 - Heaters

Detector Control Rack



Control Chassis & Remote Overrides

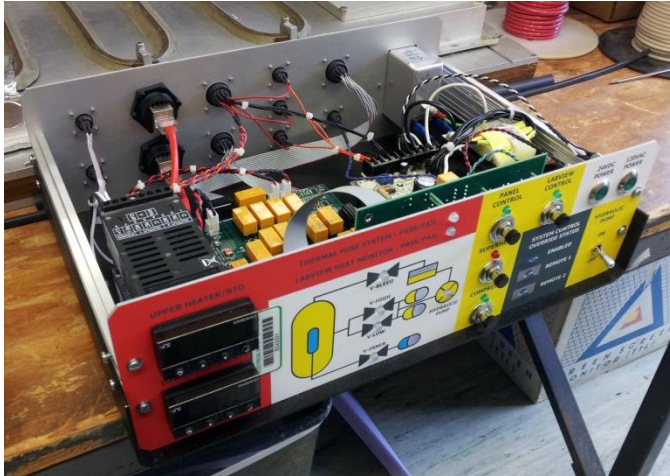

- Control Chassis Designed with Safety Interlocks
 - Heating
 - Solenoid Valves



- Two Remote Override Interfaces Allow for Complete Control of System
 - Solenoid Valves
 - Hydraulic Pump
 - Heaters

Failure Modes and Effects

- Failure of glass bubble chamber
- Failure of pump cut off switch
- Accumulator failure
- Regulator failure
- Refrigerator failure
- Power failure

Failure of glass bubble chamber

- Failure can be detected by camera remotely or by direct observation.
- N₂O (or C₂F₆) and Hg may be released into hydraulic fluid.
- The integrity of the system is not lost.
- The fluid mix can be drained back to reservoir and shipped back to ANL for recovery.

Failure of Pump Cut off

- Pump is controlled by pressure switch
 - Failure causes pump to run continuously at 1 gpm
- Multiple relief devices and control regulators will relieve pressure/excess flow back to reservoir
- ASME relief set at 1100 psi will blow down entire system should other relief paths fail.
- ΔP across glass will stay low due to equalizing bellows

Accumulator Failure

- This mode is considered very unlikely due to working pressure rating 3x higher than operating
- Accumulators are diaphragm style.
- There will be DAQ and control issues but system integrity will be maintained.
- ΔP across glass will stay low due to equalizing bellows

Regulator Failure

- N2 regulator failure only affects accumulator filling actions. This is very rare.
- Orifice limits flow and ASME relief with excess capacity is set at 1000 psi.
- N2 bottle is disconnected after charging the accumulators

Refrigerator Failure

- DAQ system will alarm unless full power failure.
- Interlocks will open CV-2 (high pressure valve) and close CV-4 (low pressure valve).
- Active fluid will stay in liquid state while system warms to room temperature
- No damage will occur to bubble chamber.
- System expert shall address issues and repair as needed.

Power Failure

- During power failure DAQ, control, pump and refrigerator stop
- CV-2 opens (default state) and CV-4 closes (default state)
- Chamber is returned to high pressure “standby” mode which is stable.
- The system will slowly warm.
- The system will stay down until reset
- Only system expert may perform reset.

Required Training

- To operate the detector users shall be trained by Brad DiGiovine
- Only system expert shall perform fluid handling procedures or adjustments to controls
- SAF 801 Rad worker I
- SAF 103 ODH
- SAF 130 Oil Spill Training (not required for all personnel and only if needed)
- SAF 132 Tunnel worker safety
- SAF 801kd RWP for tunnel access
- SAF 100 General safety

Operating Procedures

- Following procedures are developed
 - Fill procedure
 - Venting
 - Power loss
 - Fire (leave area call 911)
 - Basic user operation
 - Start/stop runs
 - Only available after system is placed in standby mode by expert
 - DAQ failure procedure
- Emergency de-energize procedure is available for all personnel but, will require that the system be shipped back to ANL for repair.

User Interface

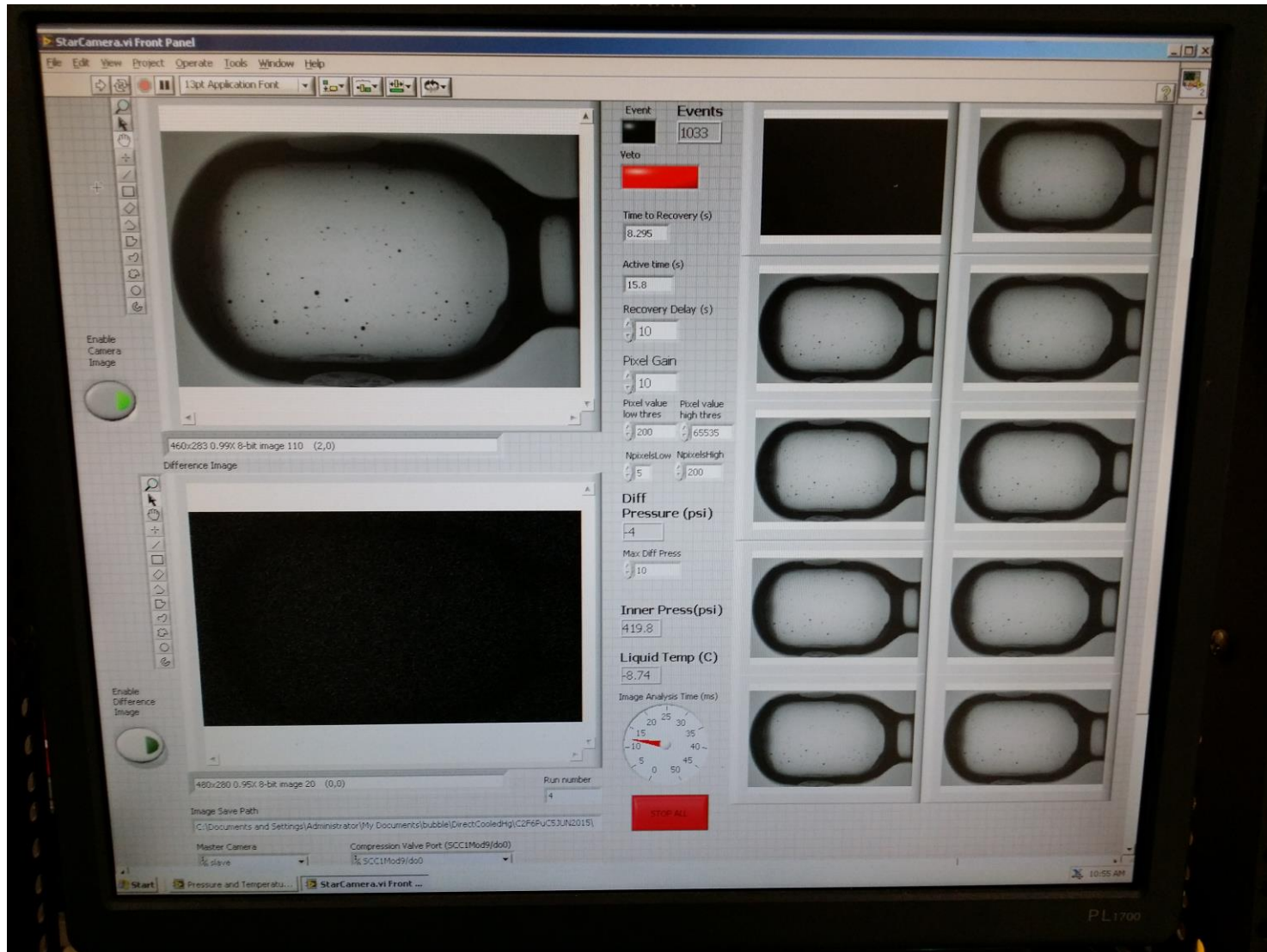

Running Adjustments

- Test is to understand and optimize the detector performance.
- Only system expert shall make/approve changes to the fluid system
- Possible adjustments include
 - Operating pressure/temperature
 - Quench pressure
 - Fluid levels
 - Dead time