



UNIVERSITY
of York

K_L Flux Monitor

Mikhail Bashkanov

KLF Flux monitor

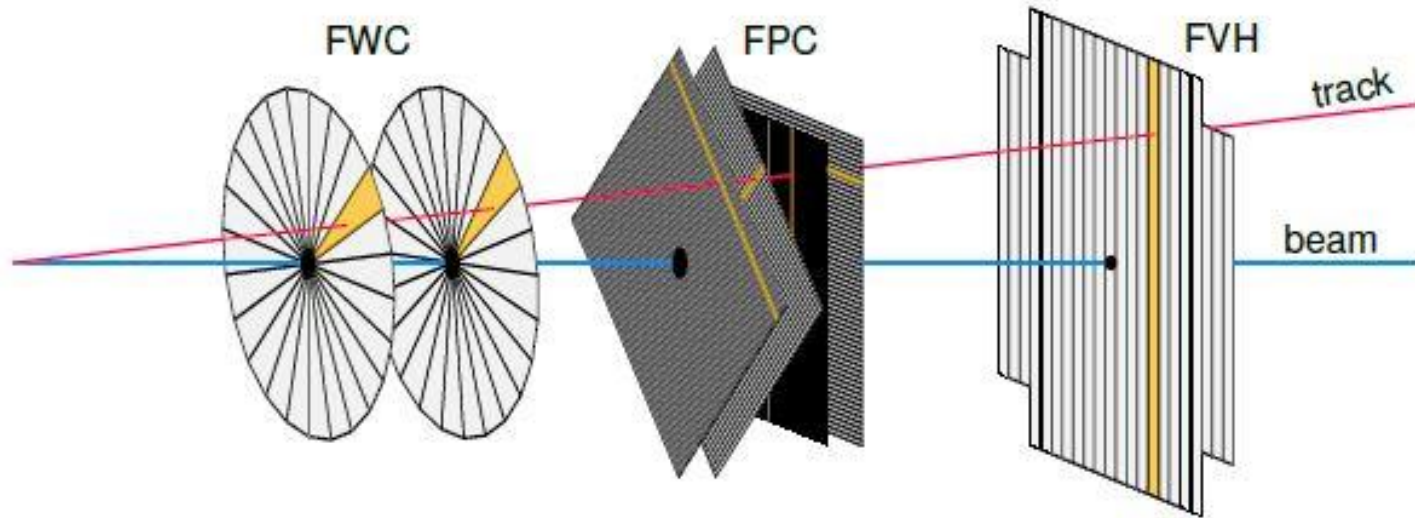

Used Wasa ToF system
Used Wasa Trackers
NO Magnet

- ⊕ Good performance
- ⊕ Cheap
- ⊗ Limited capabilities in rare kaon decay studies

KLF Flux monitor

Tracker

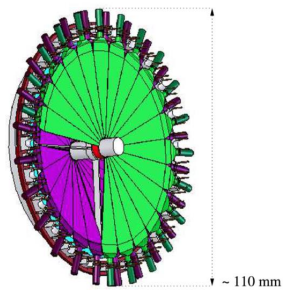

Start Detector
(start time for TOF)

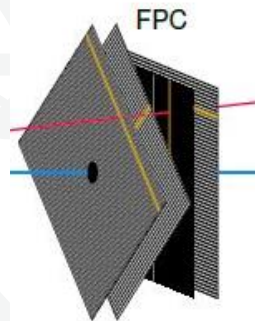

Coarse plastic tracker

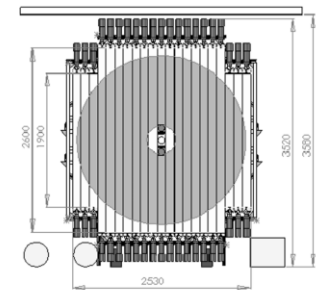
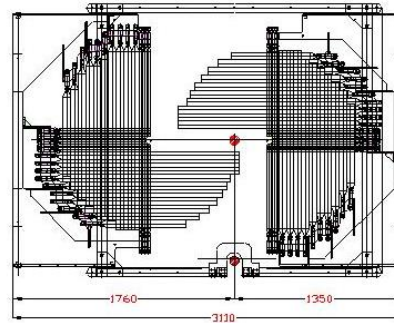

Stop Detector
(stop time for TOF)

K_L monitoring

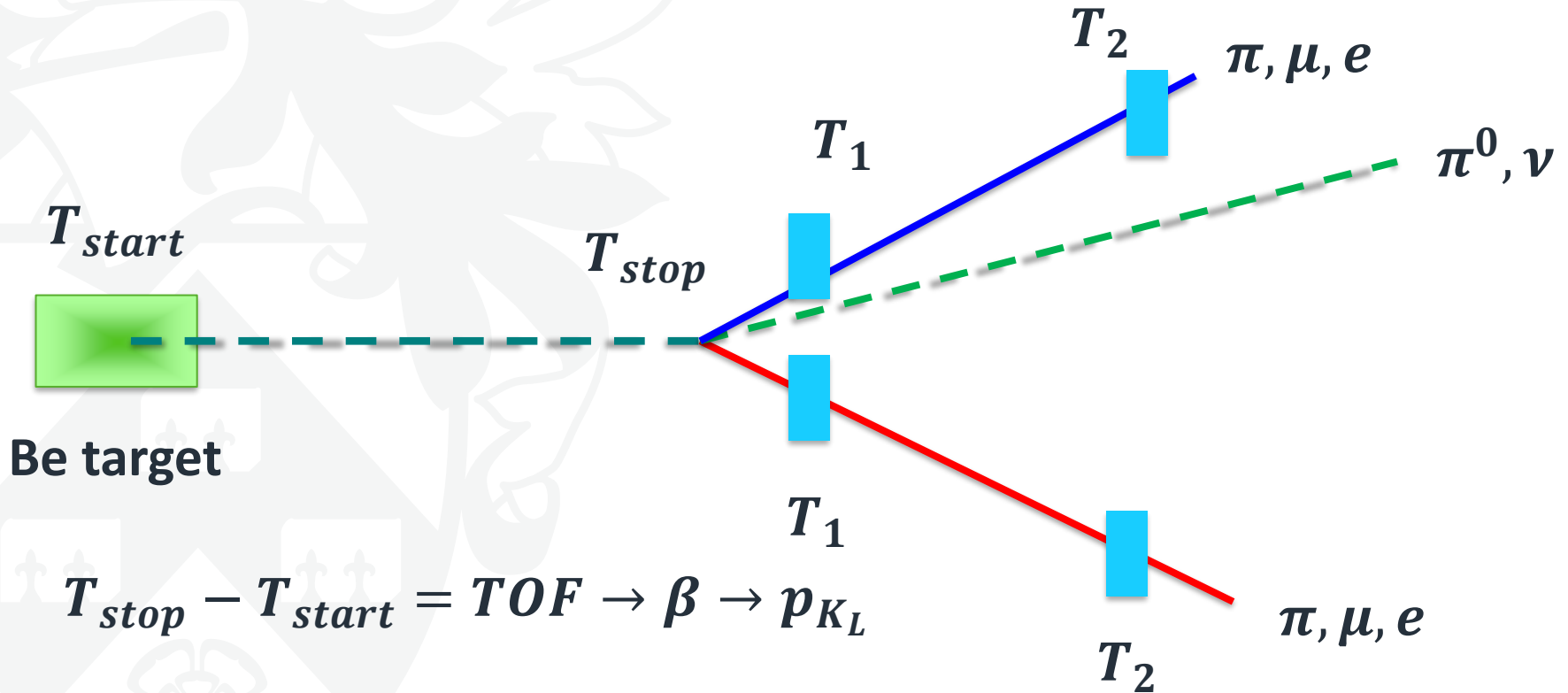

Be target

$$T_{stop} - T_{start} = TOF \rightarrow \beta \rightarrow p_{K_L}$$

- All channels with 2 charged particles can be used
- No PID required



UNIVERSITY
of York

Detectors

Detectors

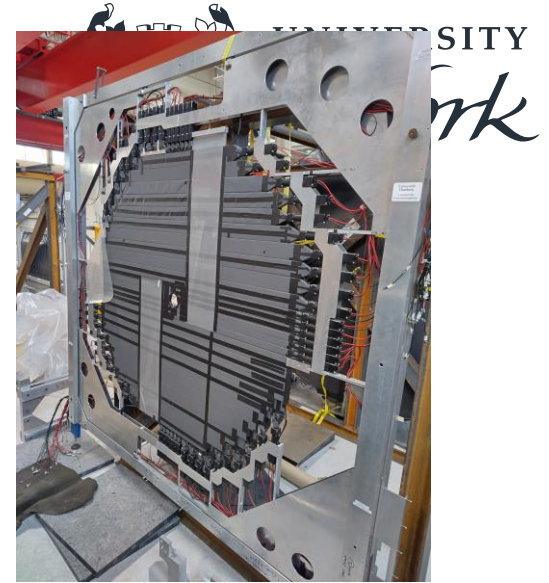

- Uninstalled
- Prepared for packing/boxing (transportation company)
- Transportation [paid Juelich]
- Paper work [ongoing]
- Delivery time JLab [Autumn 2024]
- Uninstallation – 5 days for 5 people

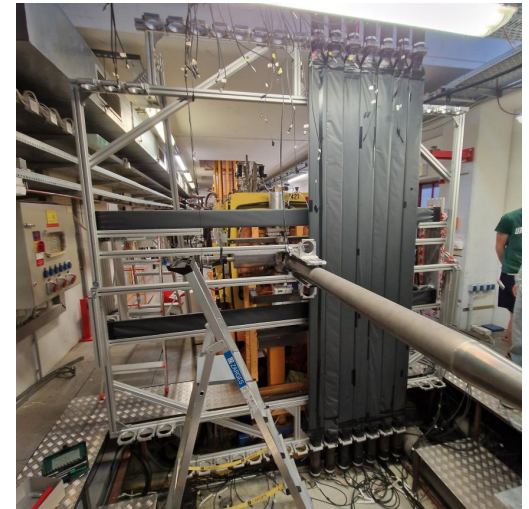



UNIVERSITY
of York

Calibration

Start detector



Before calibration

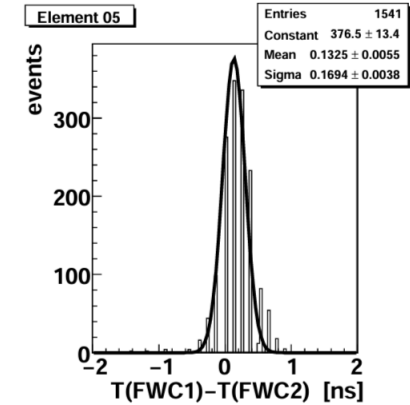
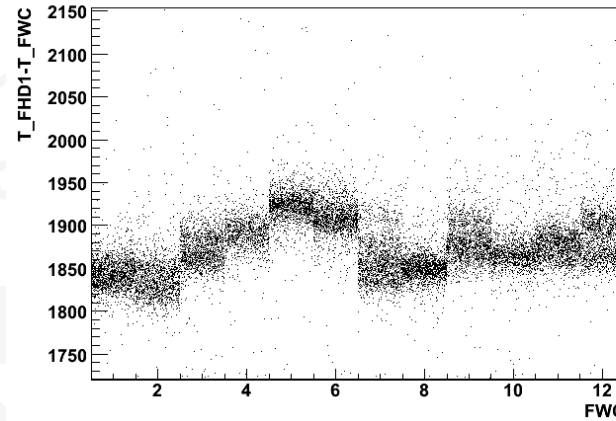
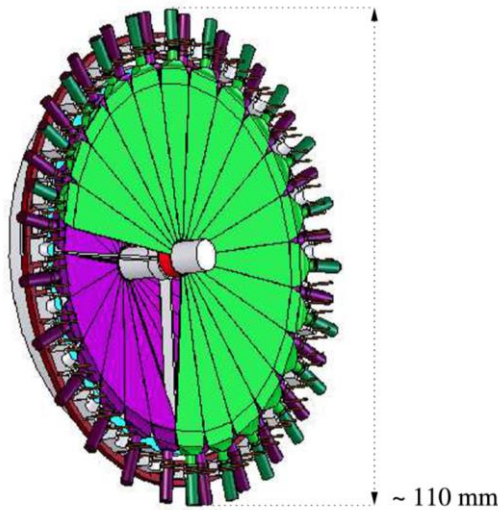

- Two layers shifted by half element
- Standalone calibration is possible with any charge tracks
 - Time
 - Offsets
 - Propagation
 - Walk
 - Energy
 - nonlinearities

FRI (plastic tracker) FRI

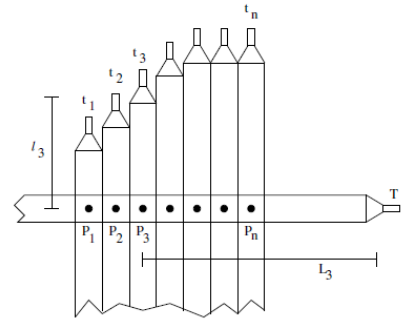
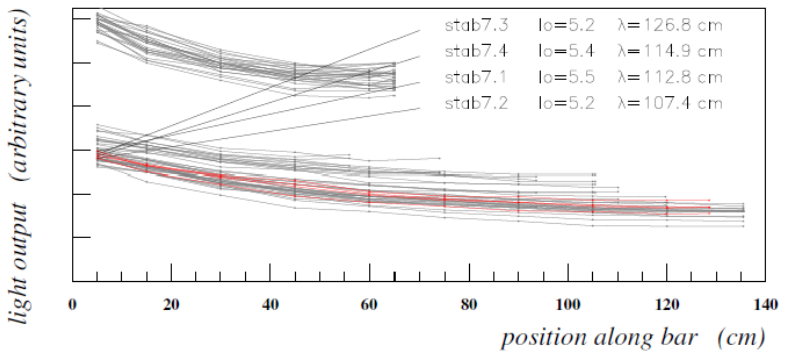

$$\Delta t_n = (T - \frac{l_n}{c_{eff}}) - (t_n - \frac{l_n}{c_{eff}})$$

$$C_{i+1} = C_i + \frac{\sum_{j=1}^n \Delta t_n}{n}$$

t_n, T = TDC Hit time
 C_i = Time offset for horizontal bar after iteration i
 L_n, l_n = distance pixel P_n to multiplier
 c_{eff} = effect. speed of scintillation light

- Two layers design
- Positioning
- Standalone calibration is possible with any charge tracks
 - Time
 - Offsets
 - Propagation
 - Walk
 - Energy
 - nonlinearities

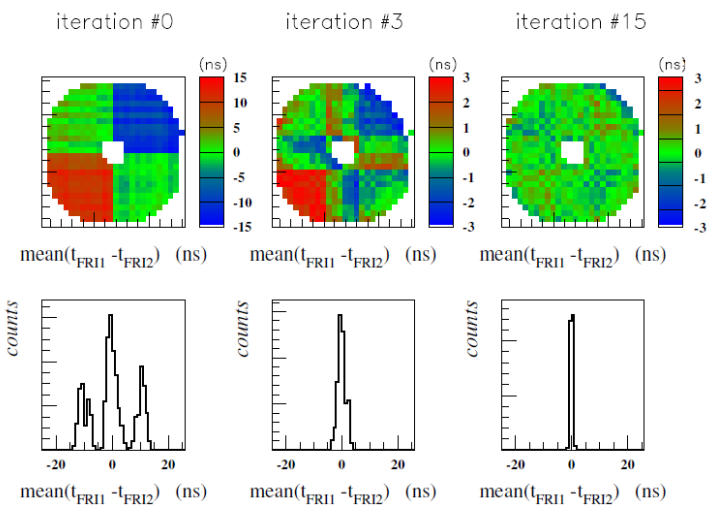

Stop detector

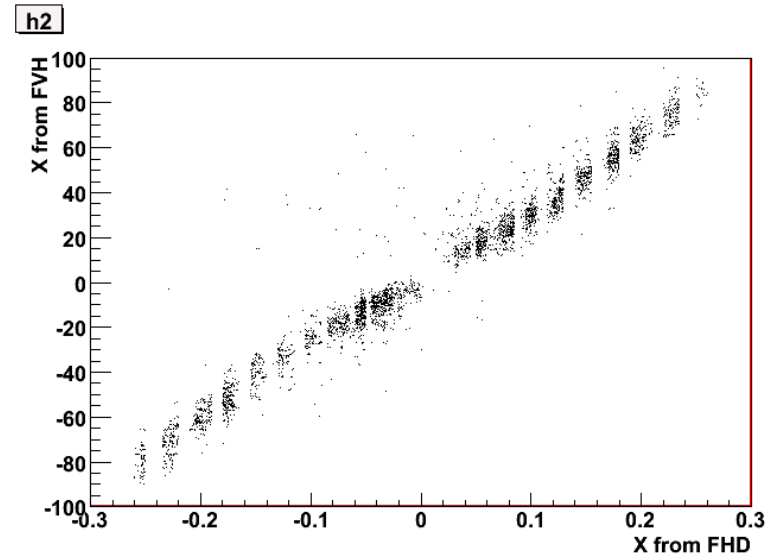

- Two-side readout
- Extra “calibration” elements
- Standalone calibration is possible with any charge tracks
 - Time
 - Offsets
 - Propagation
 - Walk
 - Energy



UNIVERSITY
of York

Absolute Normalisation

K_L monitoring

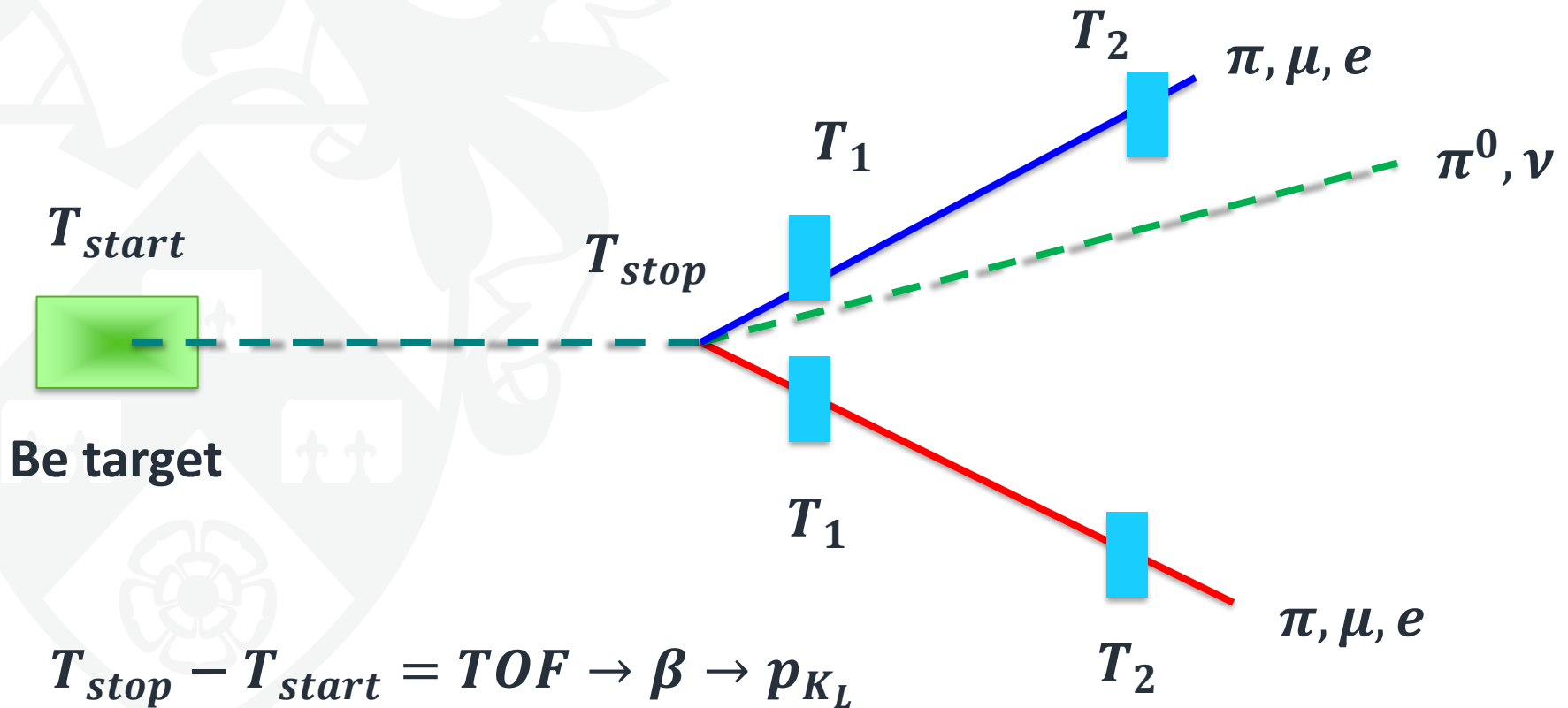



$K_L - K_S$ regeneration

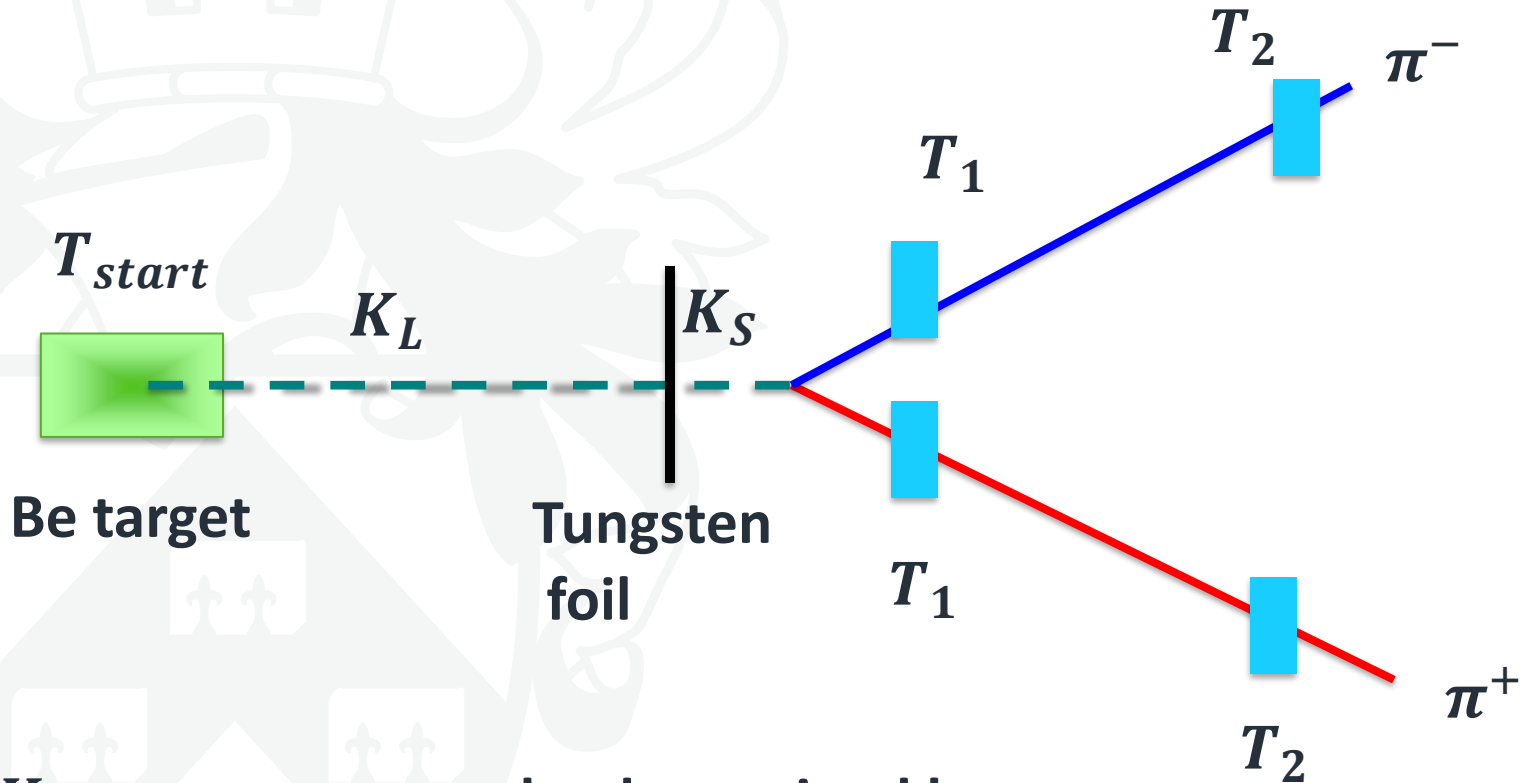

K_L momentum can be determined by

- TOF
- $\pi^+ - \pi^-$ opening angle

$K_L - K_S$ regeneration

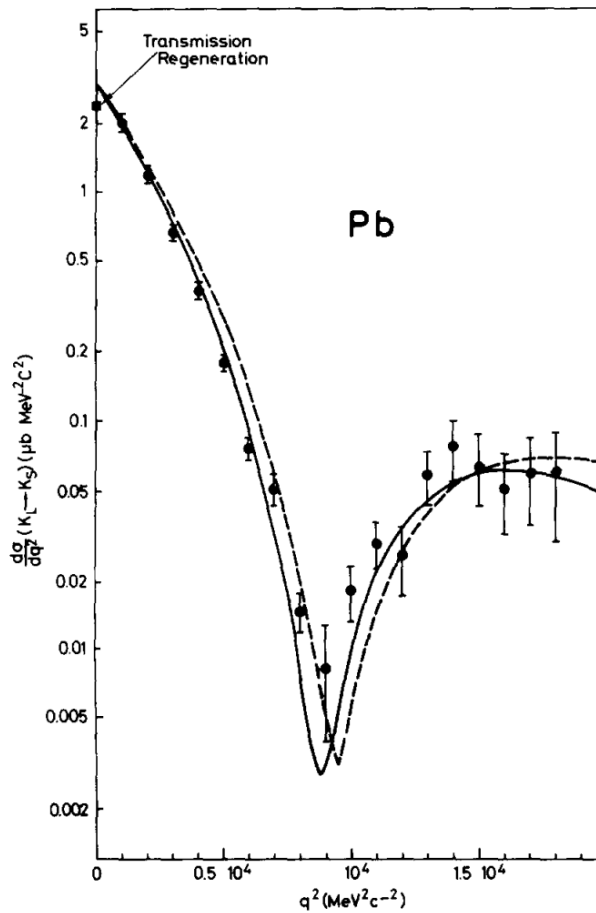

Cross-section is large

$$\sigma_{K_L} \cong \sigma_{K_S}$$

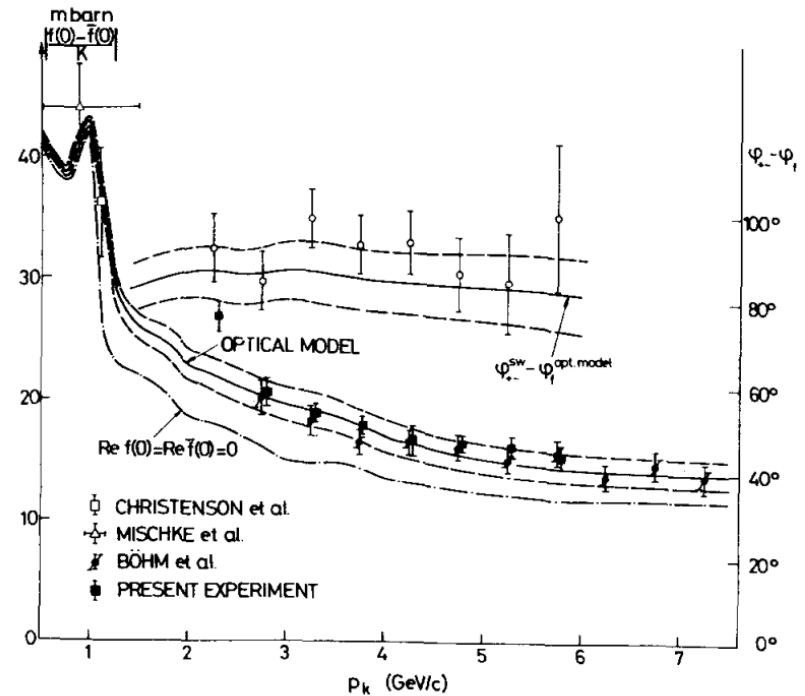
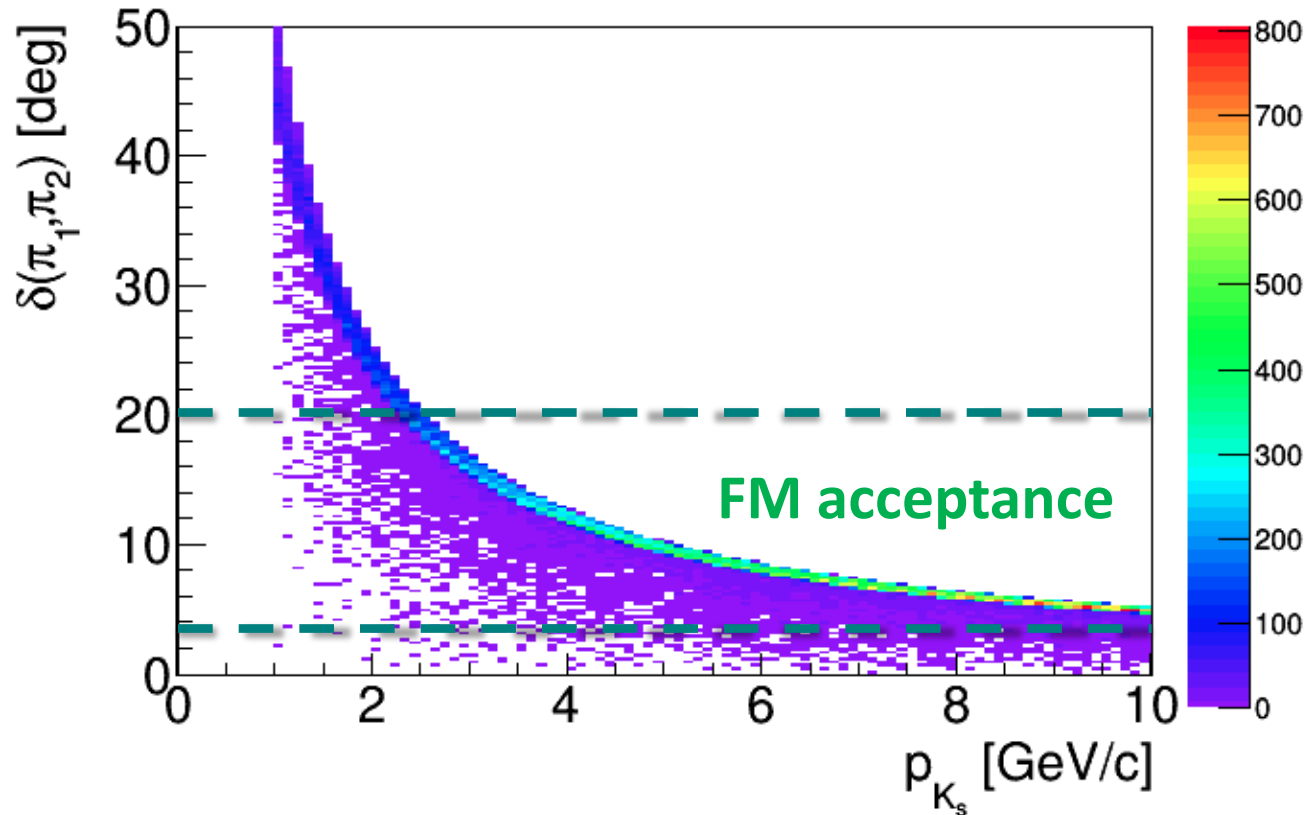

Fig. 3. Forward regeneration amplitude (left scale) and interference phase $\phi_{+-} - \phi_{+0}$ (right scale) as functions of momentum. The curve labelled $\phi_{+-}^{SW} - \phi_{+0}^{opt. model}$

$K_L - K_S$ regeneration



- Absolute time calibration via $\delta_{\pi\pi}$ vs TOF
- Alternative method to extract kaon flux – systematics
- Reliable way to monitor high-energy K_L flux

$K_L - K_S$ regeneration

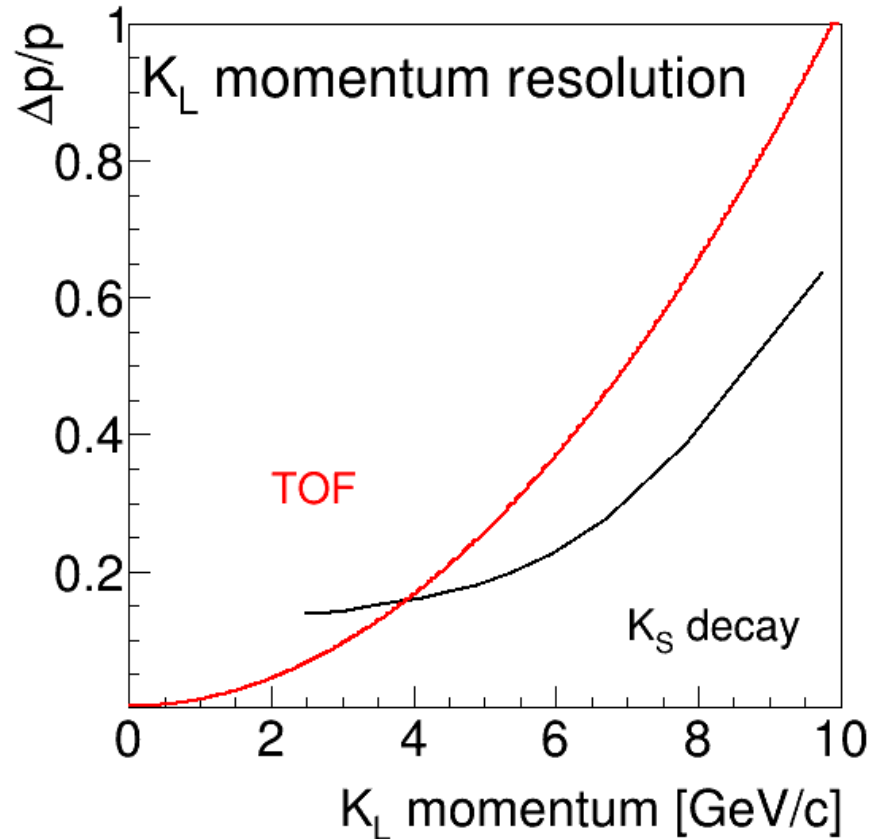

- $K_S \rightarrow \pi\pi$ about 1 event per second with ~ 1 mm thick W foil
- Highest kaon flux around 4 GeV/c

$K_L - K_S$ regeneration rates and backgrounds



Relative K_S/K_L rates in Flux monitor

Condition	K_S	K_L
Total	1	25
Coplanarity $< 5^\circ$	1	1
Vertex+ Coplanarity	1	0.03

- $K_S \rightarrow \pi\pi$ selection is clean

Status

- Hardware
 - Ready to be transported
- Electronics and readout
 - Hall-D
- Relative Calibration
 - Standalone for each plastic detector (multilayer design)
 - Tracker – relative to start
- Absolute calibration
 - K_s
- Software
 - Standalone
 - Implementation into Hall D GEANT after FM engineering design

Wasa detectors

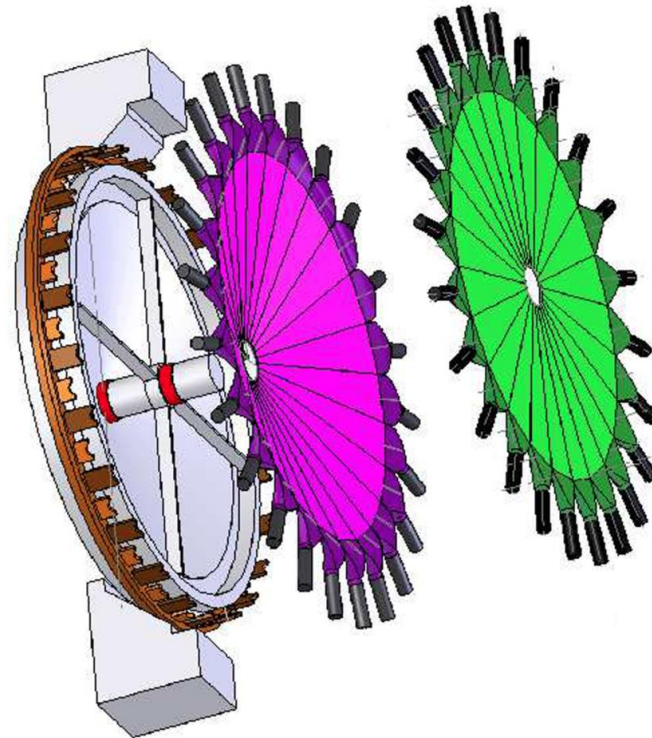
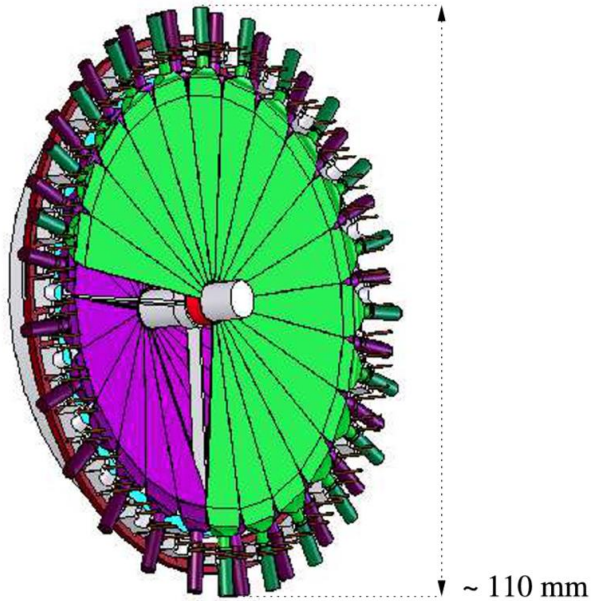

Wasa detectors

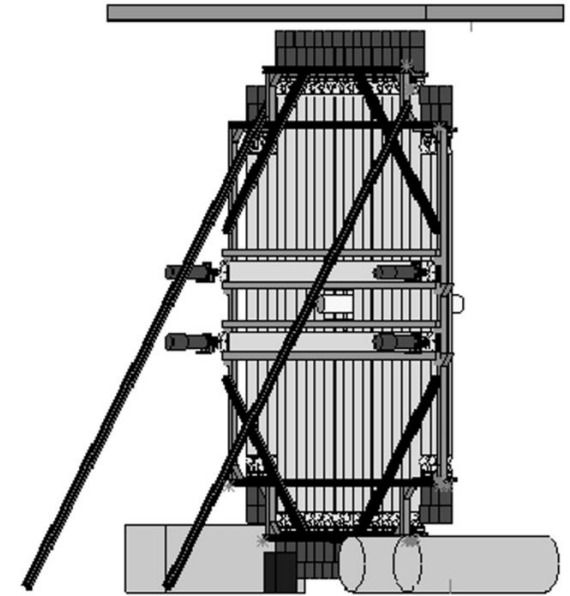
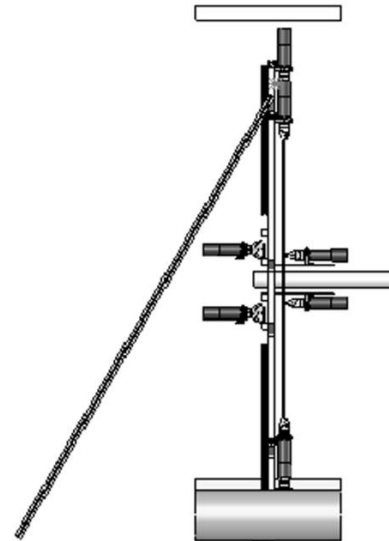
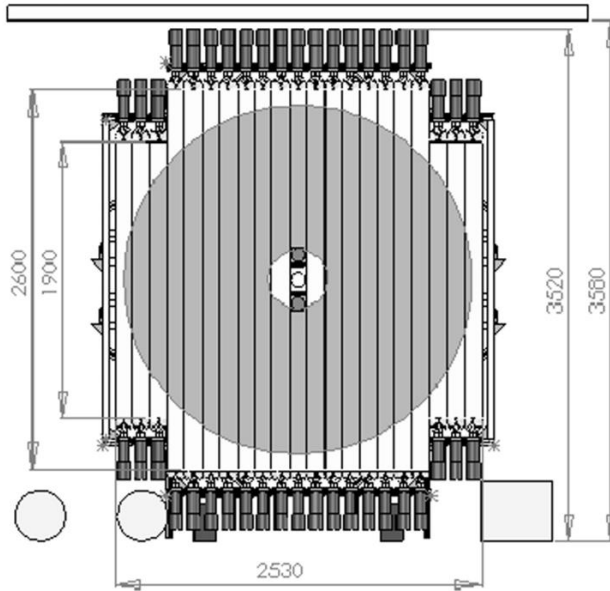

Wasa detectors



Wasa detectors

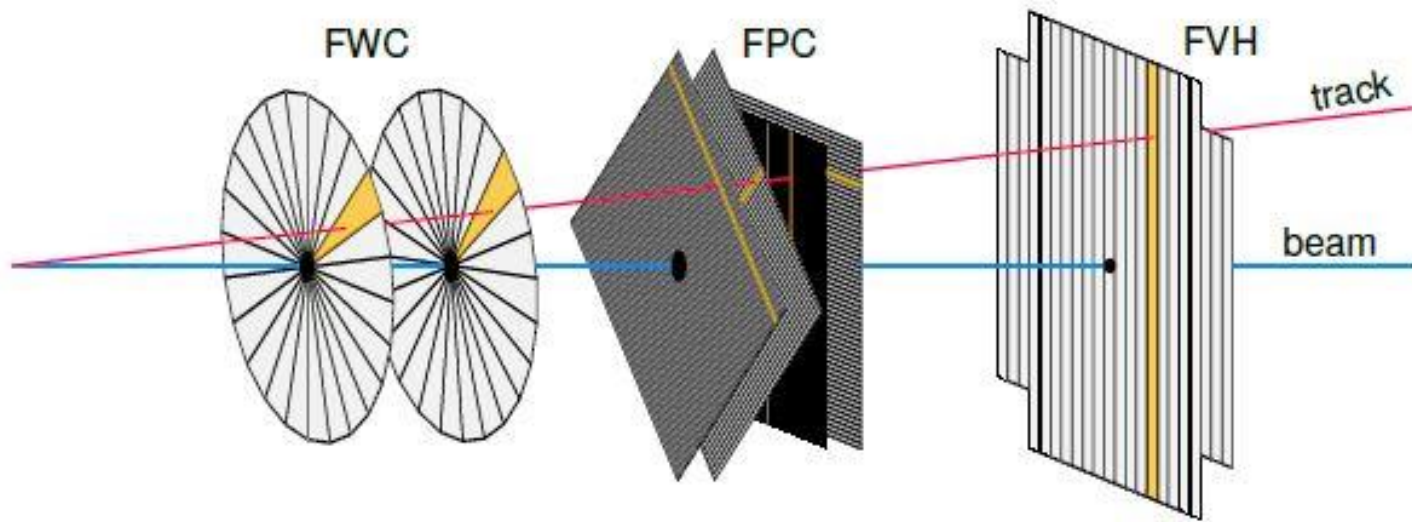

Used in TOF mode for the isospin violating $dd \rightarrow {}^4\text{He}\pi^0$ experiment

Wasa detectors

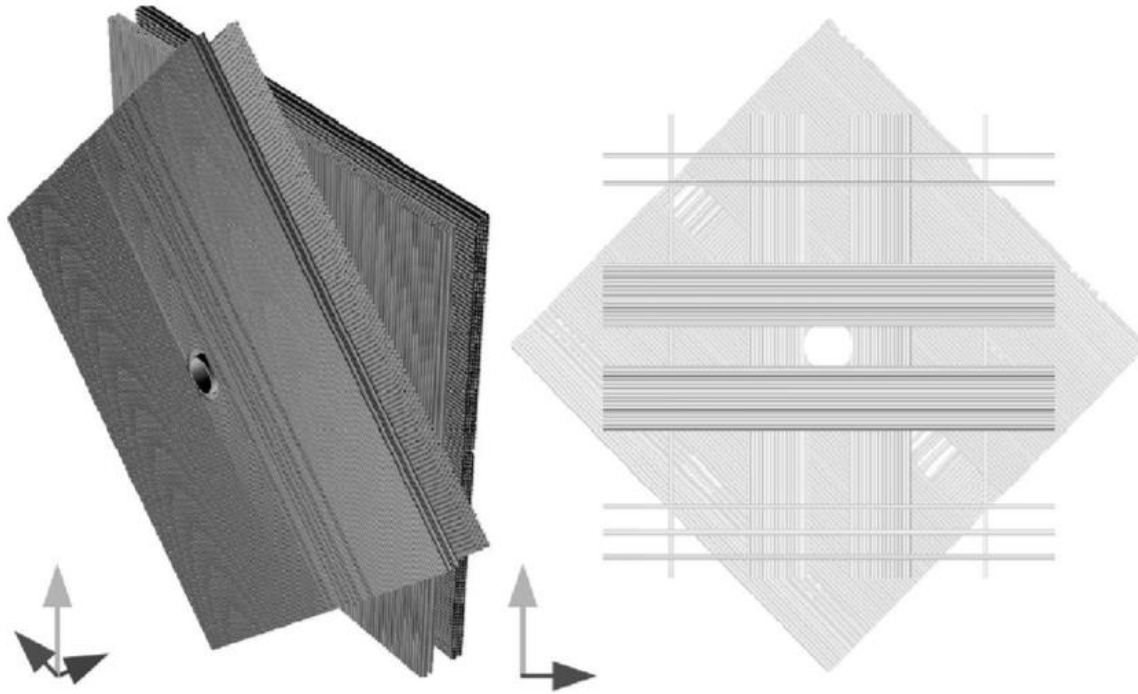

(b) *Forward Proportional Chamber FPC*

Status

- FWC (TOF start) and FVH (TOF stop)
 - Agreed on use
 - Available from Q42023
- Tracker
 - Agreed on use (Uppsala, TJ)
 - Available from Q42023

Wasa detectors

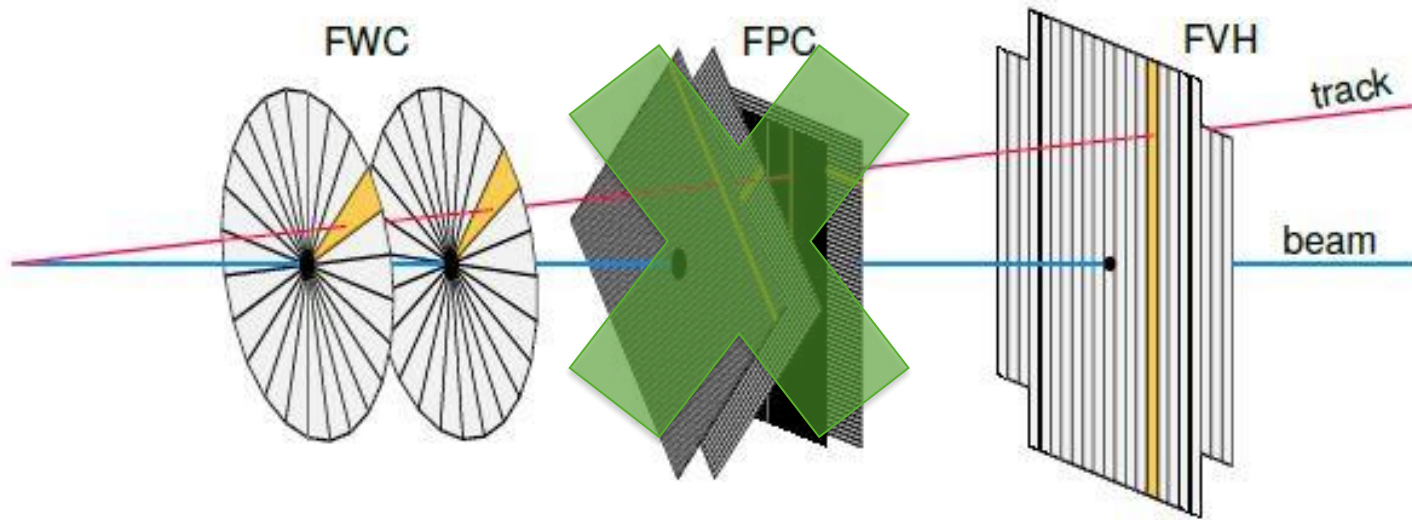

K_l time resolution due to position in Be

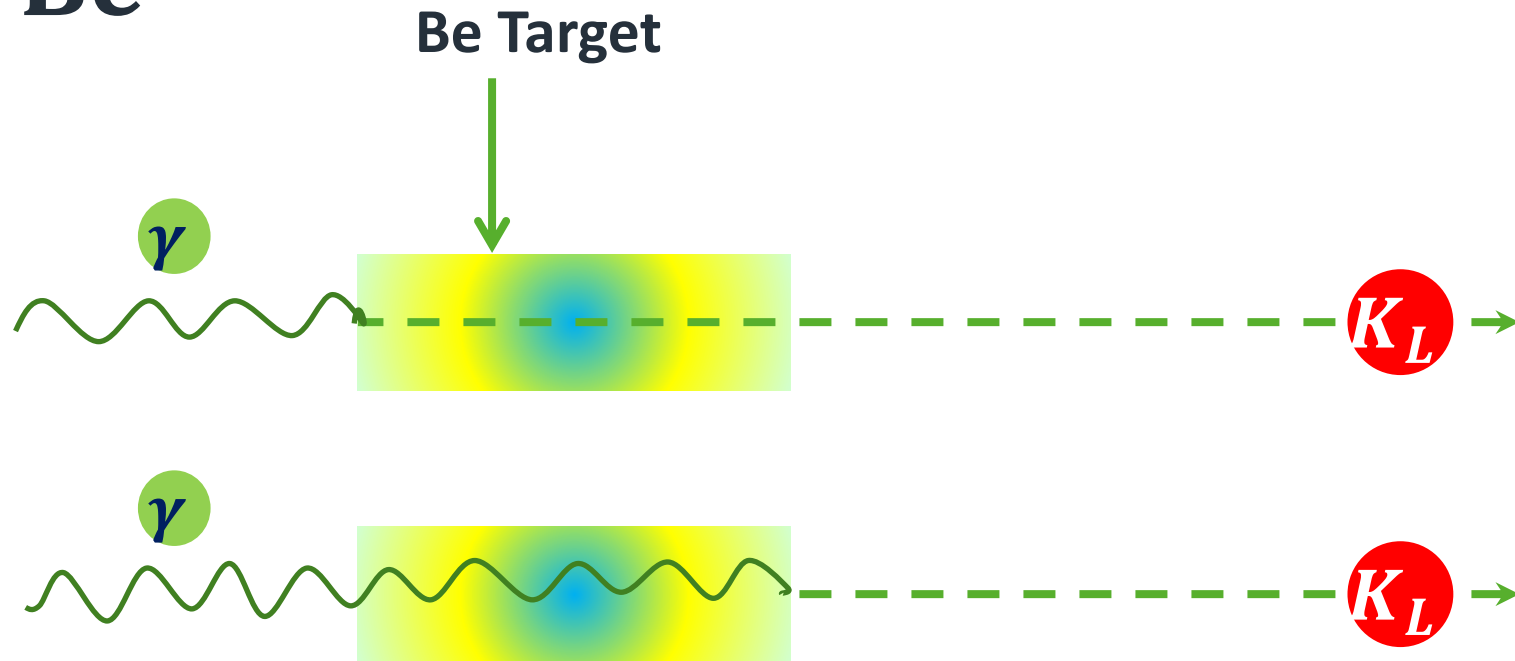

$$\Delta t = \frac{L}{c\beta_{K_l}} - \frac{L}{c} = \frac{L}{c} \left(\frac{1}{\beta_{K_l}} - 1 \right)$$

For $L=40\text{cm}$ and $p_{K_l} > 800\text{MeV}/c, \Delta t < 150\text{ps}$

K_L time resolution due to position in Be

δt vs p

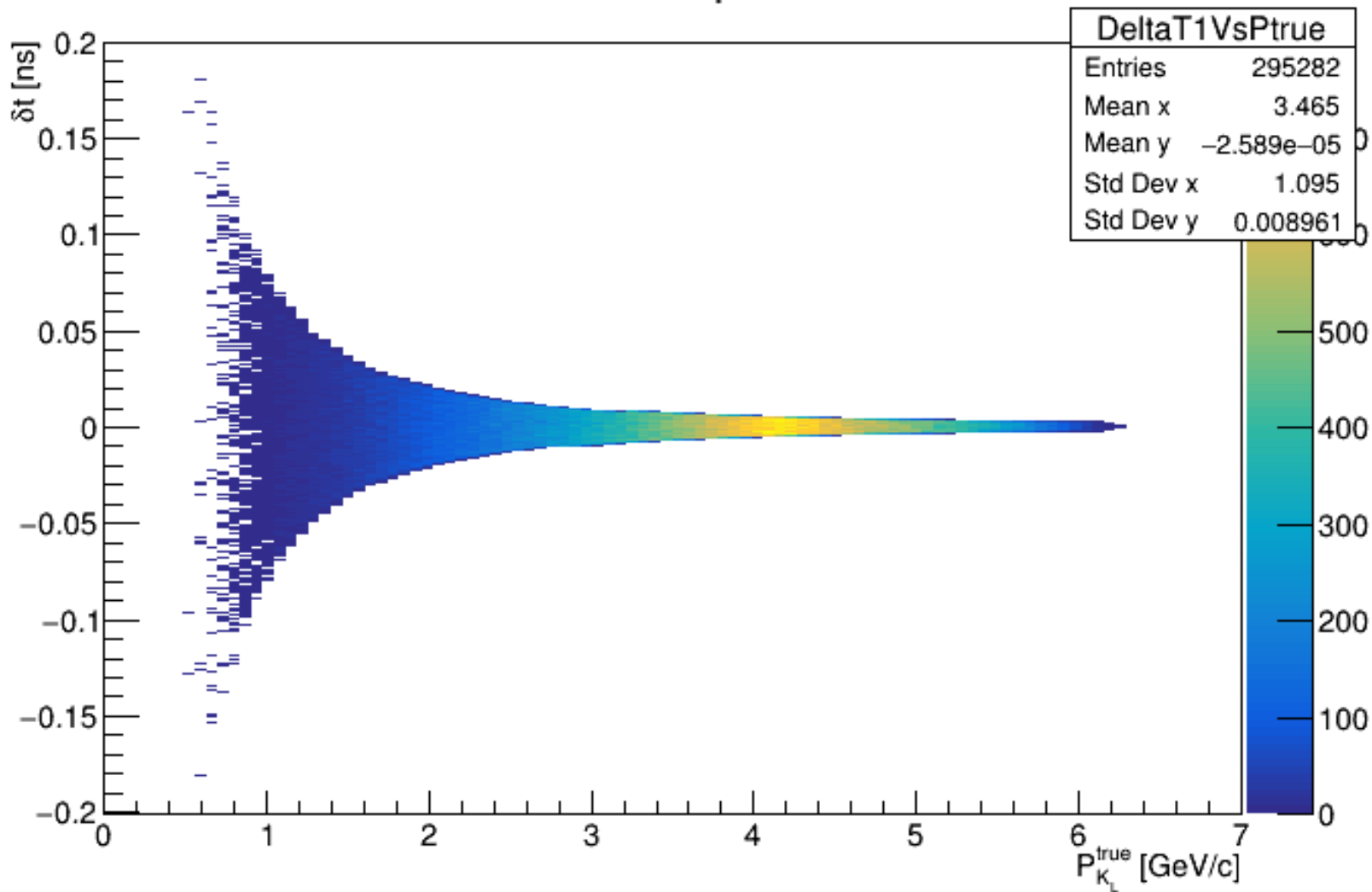

“No tracker” K_L time resolution

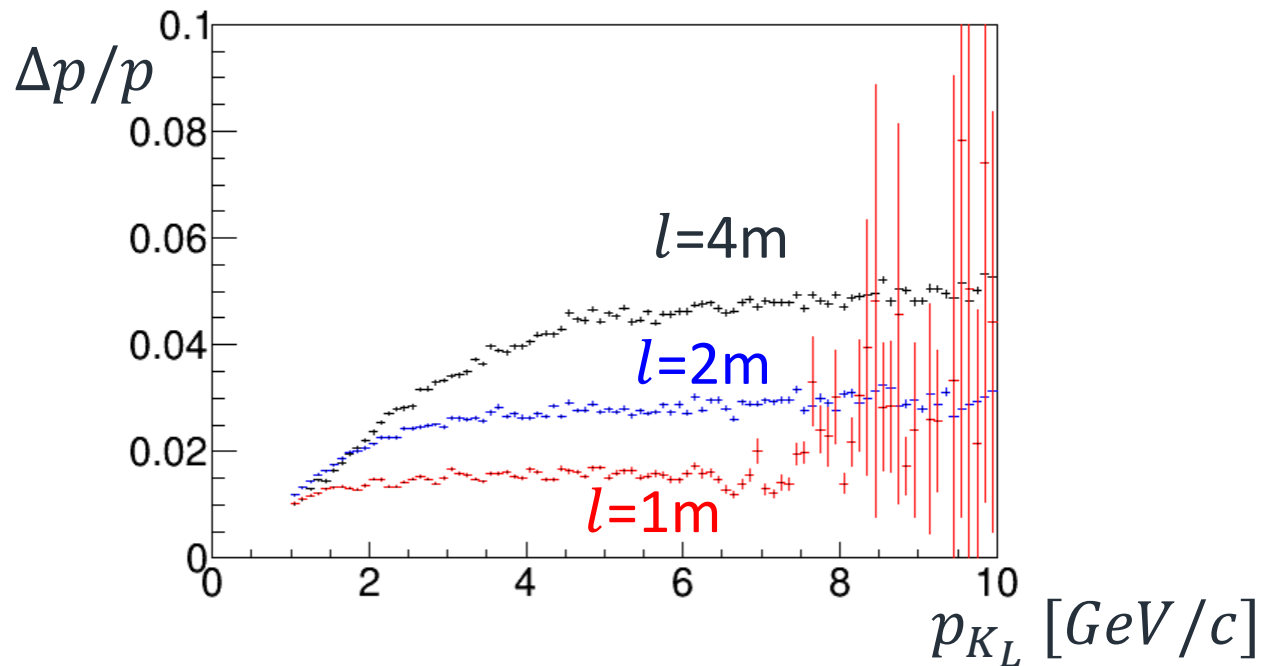
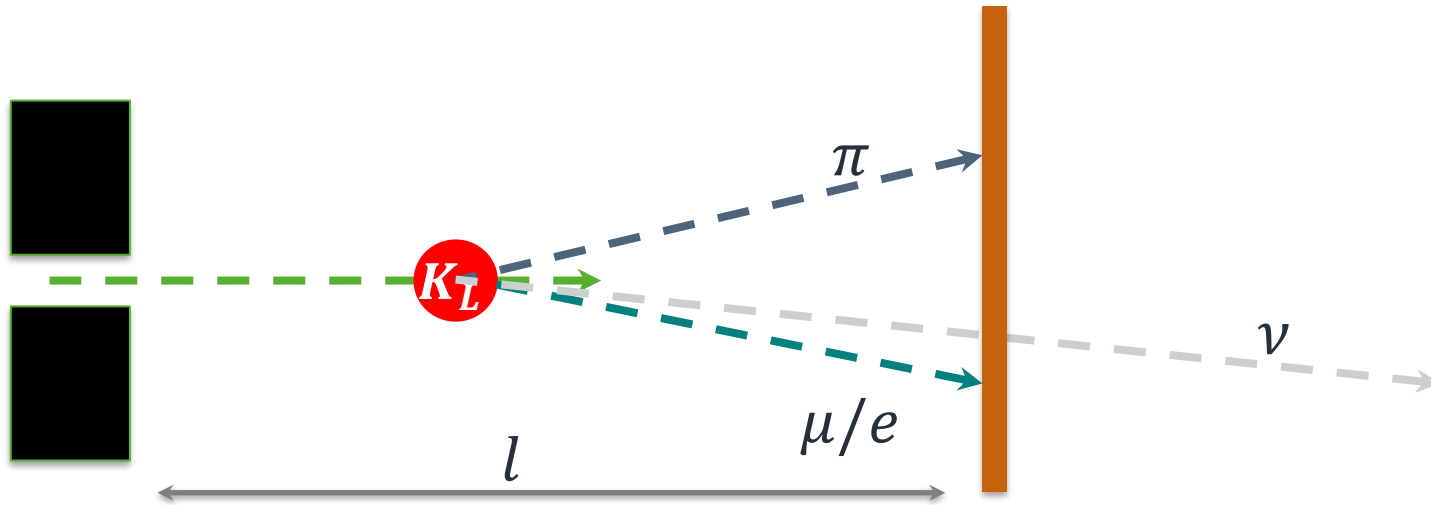

Status

- 3 options for the Flux monitor
 - Price
 - Performance
 - Byproduct research (rare decays)
 - Background suppression

KLF FM Readiness questions



UNIVERSITY
of York

- What is the status of the conceptual design of the Flux Monitor (KFM)?

KLF FM Readiness questions



UNIVERSITY
of York

- What is the status of the conceptual design of the Flux Monitor (KFM)?
→ Conceptual design is ready

K_l flux monitor location



Be target

LH2/LD2 target

24 m

Flux Monitor

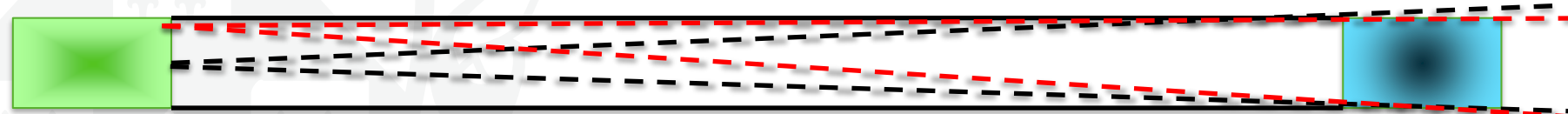

K_L decays

	Br, %
$K_L \rightarrow \pi^\pm e^\mp \nu_e$	40.55
$K_L \rightarrow \pi^\pm \mu^\mp \nu_\mu$	27.04
$K_L \rightarrow \pi^+ \pi^- \pi^0$	12.54
$K_L \rightarrow \pi^0 \pi^0 \pi^0$	19.52

- **~ 21% of kaons decays in flight**
- **Any decay with charged particles can be used**

K_L flux monitor location

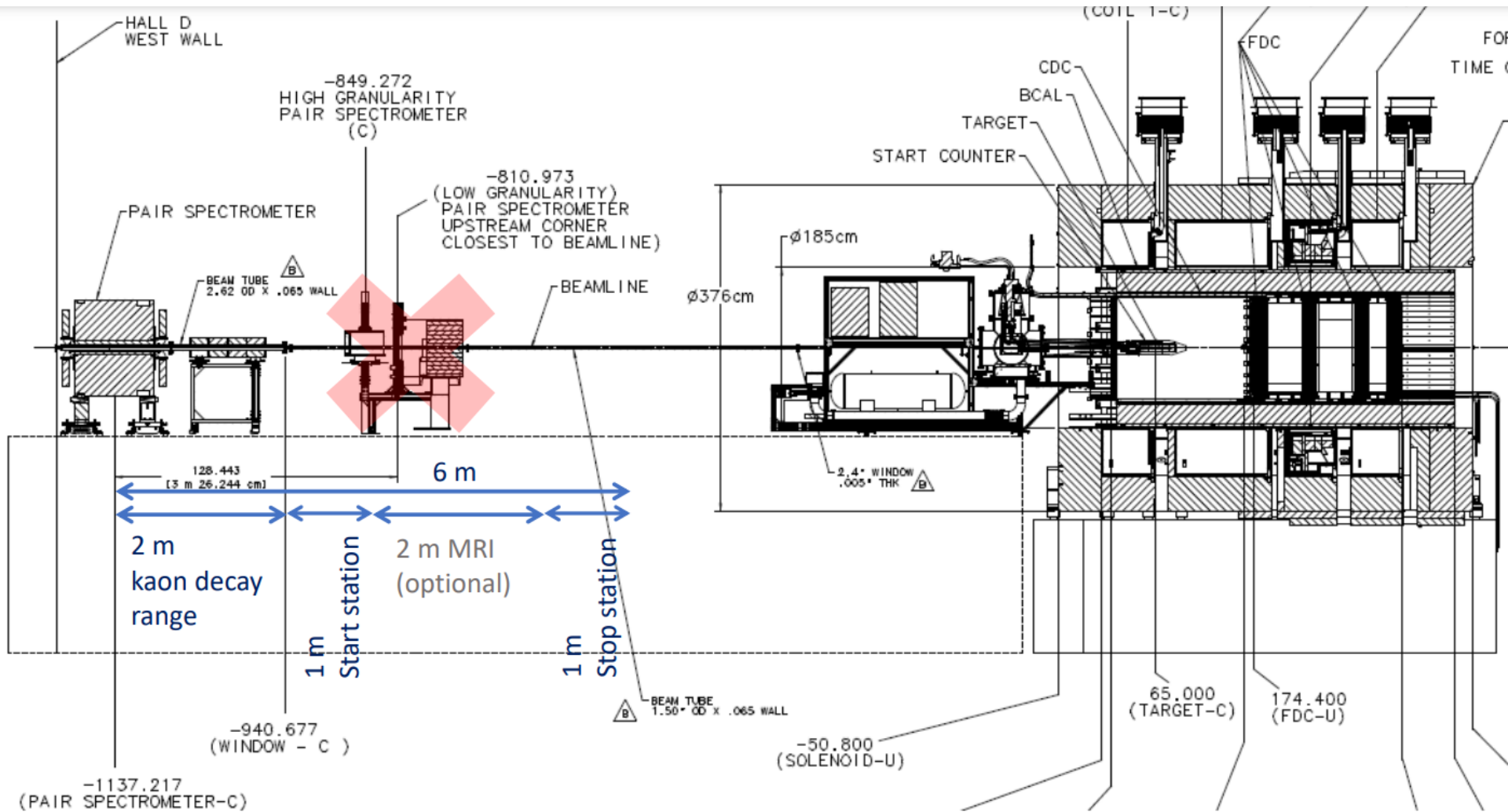

Flux monitor location

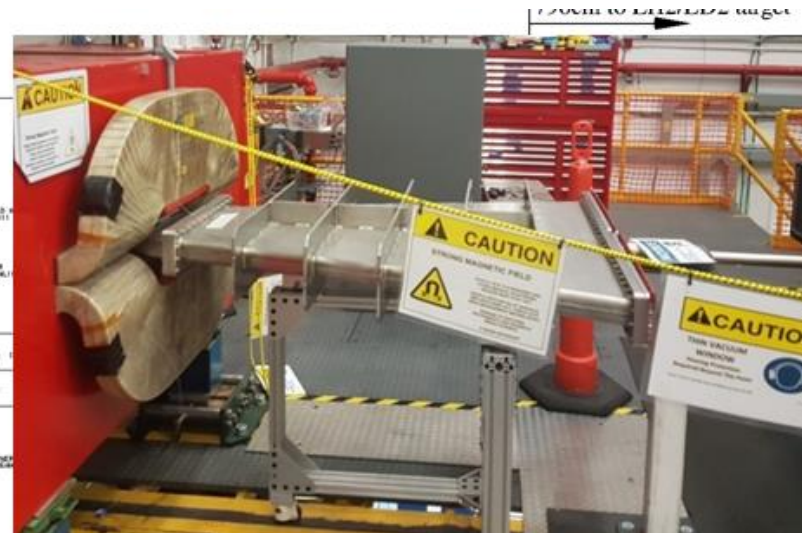
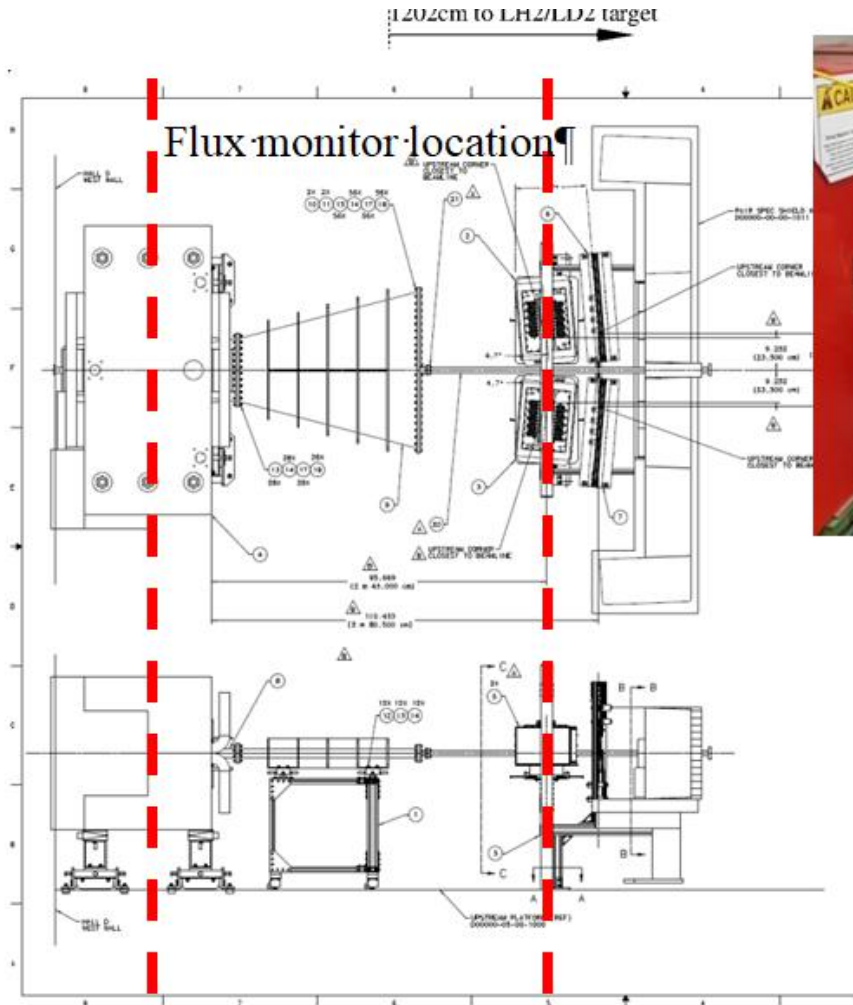



UNIVERSITY
of York

Detectors

Start Detector

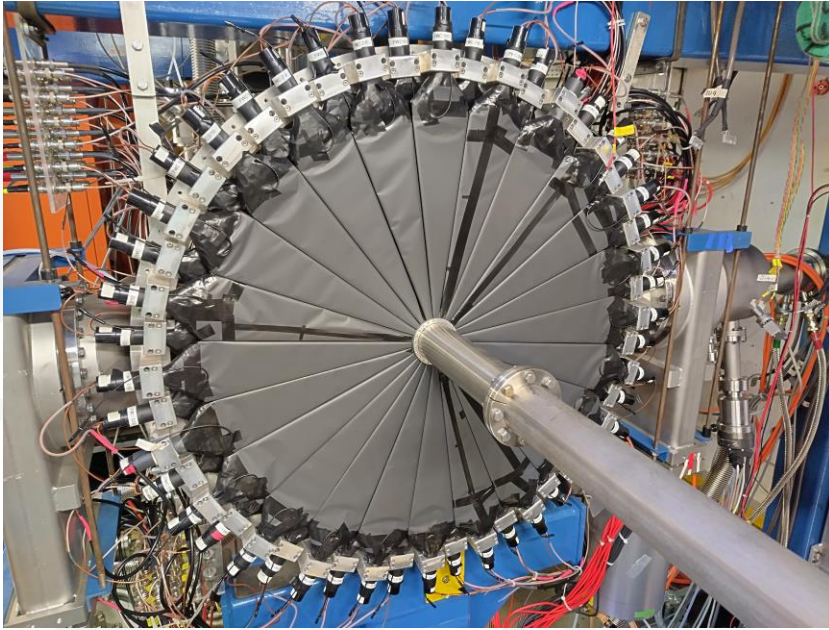

- Uninstalled
- Prepared for packing (transportation company)
- Transportation [paid Juelich]
- Paper work [ongoing]
- Delivery time JLab [Autumn 2024]

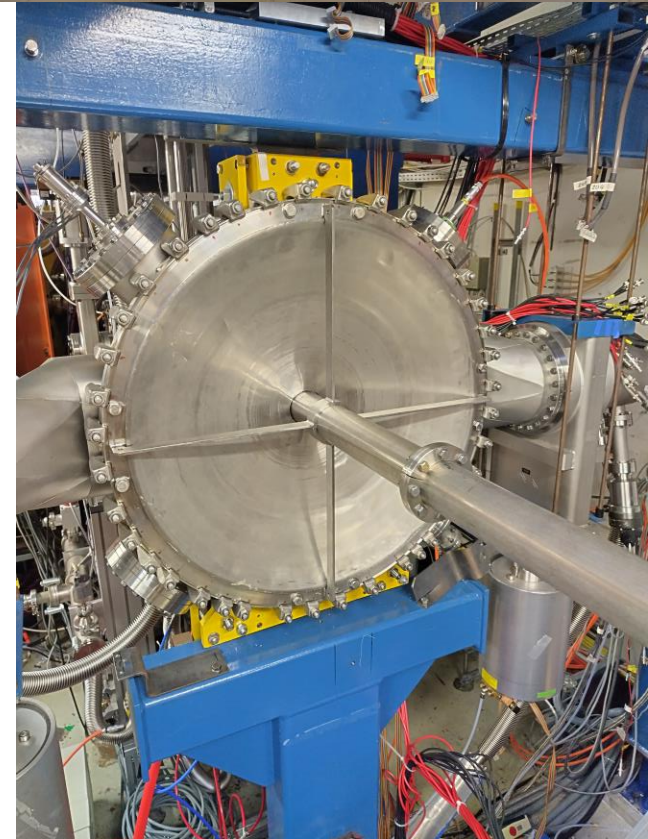

Tracker

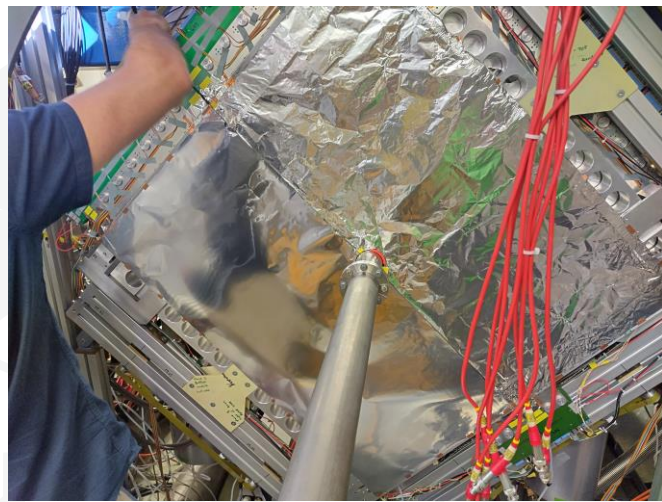

- Uninstalled and temporary boxed
- Boxes modification (transportation company)
- Transportation [paid Juelich]
- Paper work [ongoing]
- Delivery time JLab [Autumn 2024]



FRI (plastic tracker)

- Changed to transportation position
- Box
(transportation company)
- Transportation [paid Juelich]
- Paper work [ongoing]
- Delivery time JLab [Autumn 2024]

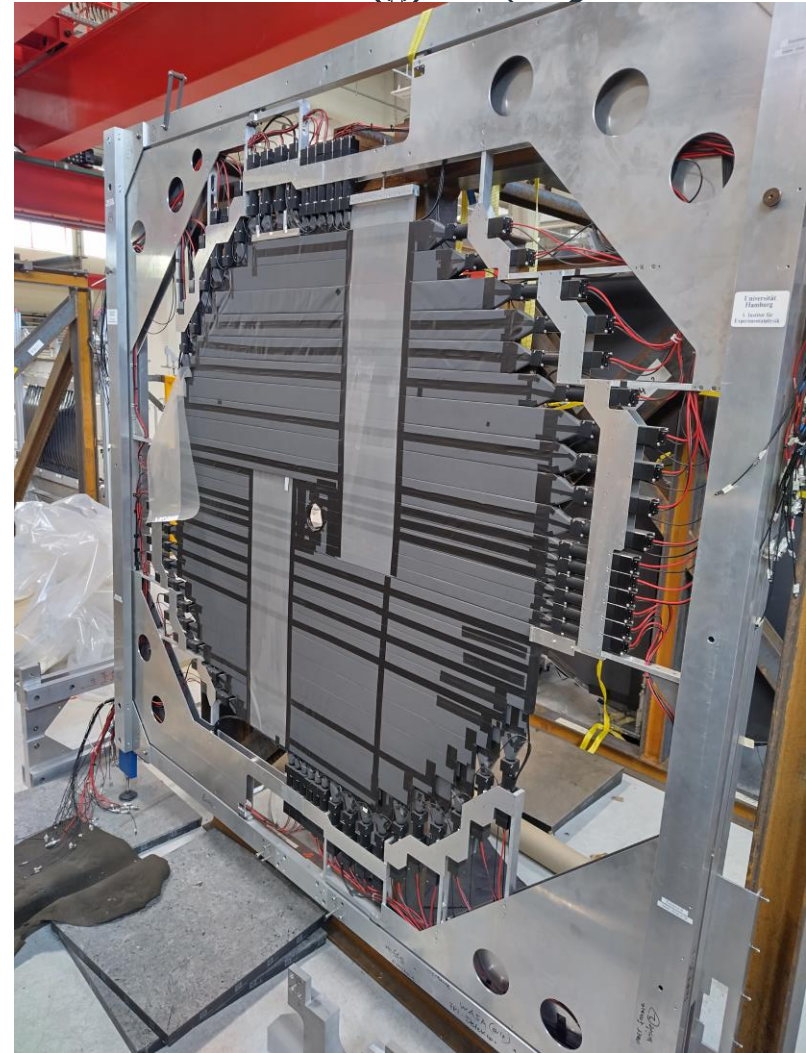

Stop detector

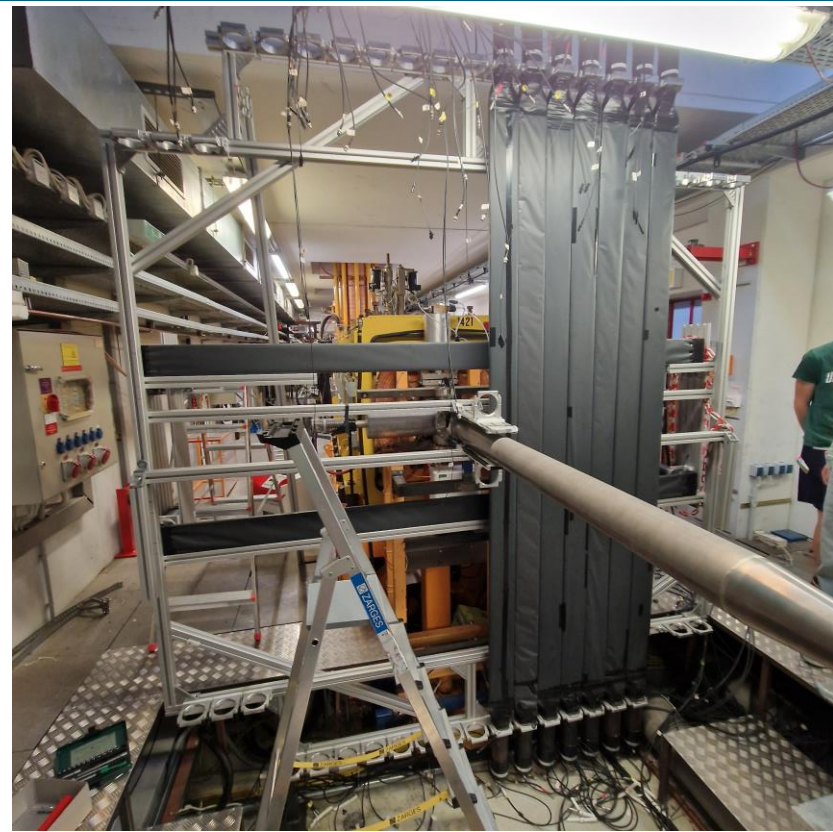

- Uninstalled, including support structure
- Box
(transportation company)
- Transportation [paid Juelich]
- Paper work [ongoing]
- Delivery time JLab [Autumn 2024]
- Few elements needs to be reglued