

Simultaneous Beam Delivery with Parity Quality Beam

KLF Phase I ERR

**Accelerator Parity-Quality-
Beam Liaison: Riad Suleiman**

Riad Suleiman

The logo for Jefferson Lab, featuring the text "Jefferson Lab" in a bold, sans-serif font. A red swoosh underline is positioned beneath the word "Jefferson".

August 02, 2023



U.S. DEPARTMENT OF
ENERGY

Office of
Science



Outline

- MOLLER Experiment
- Co-operation of KLF with MOLLER:
 - Photocathode Effects
 - Injector Optimization
 - Sub-harmonic Beam Loading in Cavities
- KLF Laser Status
- Schedule and Summary

Parity-Violating Experiments at CEBAF

PV Experiment	Energy (GeV)	Pol (%)	I (μ A)	Target	A_{pv} (ppb)	Charge Asym (ppb)	Position Diff (nm)	Angle Diff (nrad)	Size Asym($\delta\sigma/\sigma$)
HAPPEX-I 1998 – 1999	3.3	38.8 68.8	100 40	^1H (15 cm)	15,050	200	12	3	$<10^{-3}$
G0-Forward 2003 – 2004	3.0	73.7	40	^1H (20 cm)	3,000- 40,000	300 \pm 300	7 \pm 4	3 \pm 1	$<10^{-3}$
HAPPEX-II 2004 – 2005	3.03	87.1	55	^1H , ^4He (20 cm)	1,580	400	2	0.25	$<10^{-3}$
G0-Backward 2006 – 2007	0.359, 0.688	85.8	60	^1H , ^2H (20 cm)	9,700- 37,400	-30 \pm 300	47 \pm 9	1.2 \pm 0.5	$<10^{-3}$
HAPPEX-III 2009	3.484	89.4	100	^1H (25 cm)	23,800	200 \pm 10	3	0.5 \pm 0.1	$<10^{-3}$
PVDIS 2009	6.067	89.0	105	^2H (20 cm)	60,000- 160,000	100	100	40	$<10^{-3}$
PREx-I 2010	1.056	89.2	70	^{208}Pb (0.5 mm)	657 \pm 60	85 \pm 1	4	1	$<10^{-4}$
QWeak 2010 – 2012	1.162	88.7	180	^1H (34 cm)	226.5 \pm 9.3	20.5 \pm 1.7	-4.6 \pm 0.2	-0.07 \pm 0.01	$<10^{-4}$
PREx-II 2019	0.953	89.7	70	^{208}Pb (0.5 mm)	550 \pm 18	20.7 \pm 0.2	2.2 \pm 4	0.3 \pm 0.3	$<6\times 10^{-5}$
CREx 2019-2020	2.18	87.1	150	^{48}Ca (5 mm)	2668 \pm 113	-88 \pm 026	-5.2 \pm 3.6	- 0.13 \pm 0.08	$<6\times 10^{-5}$
MOLLER 2026-2028	10.8	90	65	^1H (125 cm)	35.6 \pm 0.74	<10	<0.6	<0.12	$<10^{-5}$

MOLLER Experiment

1. MOLLER Apparatus is designed for nominal beam energy: 10.8 ± 0.2 GeV with low RF trip rate (<6/h)
2. 65 μ A with 90% polarization (max 70 μ A for target studies)
3. Fast helicity reversal:
 - I. 1920 Hz, 10 μ sec settle time, 64-window pattern, 128-window delay
4. Slow helicity reversals:
 - I. Insertable half-wave plate (IHWP)
 - II. Wien Filters (using new 200 keV injector)
 - III. g_e -2 ($\Delta E \sim 0.10$ GeV)
5. Feedbacks on:
 - I. Helicity-correlated beam charge
 - II. Helicity-correlated position and angle
 - III. Polarization orientation
6. Small helicity-correlated beam asymmetries
7. Adequate adiabatic damping of transverse phase-space (for both xx' and yy') – a factor of 100 is desired, a factor of 10 is required. Ideally,
$$\sqrt{P_f/P_{gun}} = \sqrt{10800/0.494} = 148$$
8. Acceptable beam halo (MOLLER Halo Monitor: to be specified, Compton Polarimeter: <100 Hz/ μ A)

Running 4-Halls during KLF and MOLLER

- Hall A (MOLLER):
 - 0.26 pC @ 249.5 MHz (4 ns, 65 μ A average beam current) at 11 GeV
- Hall B:
 - 0.002 pC @ 249.5 MHz (4 ns, 50 nA average beam current)
- Hall C:
 - 0.12 pC @ 249.5 MHz (4 ns, 35 μ A average beam current)
- KLF:
 - 0.32 pC @ 15.6 MHz (64 ns, 5 μ A average beam current)

Co-operation of KLF with MOLLER

- Issues:

- I. How would photocathode respond to such peak current variations?
- II. Injector optimization for parity-quality-beam (Transmission and Beam Noise, Wien Flip) vs KLF?
- III. How would RF system respond to such current variations? Sub-harmonic Beam loading in bunchers and SRF cavities in Linacs?
- IV. What else?

- Experience: G0 Forward in Hall C (2003 – 2004)

- 1.28 pC @ 32 MHz (32 ns, 40 μ A), 3rd pass (3.0 GeV)
- Note that this was the parity-violation experiment

Photocathode Effects

- Photocathode effects, e.g., Surface Charge Limit, will affect both charge in each bunch and charge asymmetry of each bunch, especially those close to KLF bunch, and overall average over whole beam
- Helicity correlated charge asymmetry on one beam affects other beams at CEBAF especially high current beams
- Parity-violation experiments in either Hall A or Hall C had to perform charge asymmetry feedback on other hall's beam – therefore, Hall D must work with MOLLER collaboration to implement a proper charge feedback system:
 - Intensity Attenuator (IA) system on laser table
 - BCM in Hall D
 - Parity data acquisition system to measure charge asymmetry

Surface Charge Limit

- Also known as Surface Photovoltage Effect, reduces NEA (χ) of GaAs: Photoelectrons trapped near GaAs surface produce opposing field that reduces NEA resulting in QE reduction at high laser power (LP),

$$QE = QE_0 \left(1 - \frac{U(LP)}{\chi + \delta U(E_s)} \right)$$

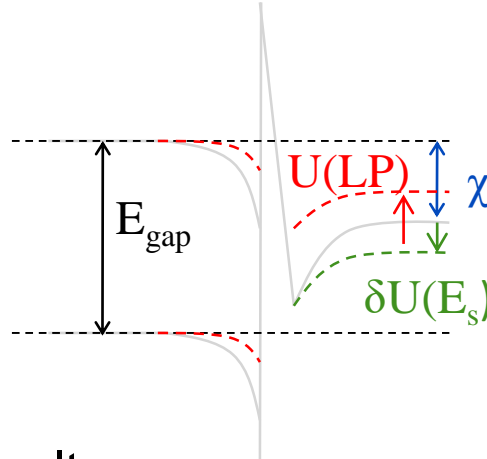

Where $U(LP)$ is up-shifting of potential barrier due to photovoltage.

Bulk GaAs, 532 nm, 100 kV

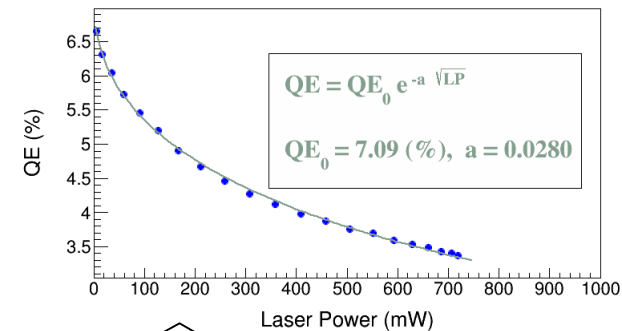
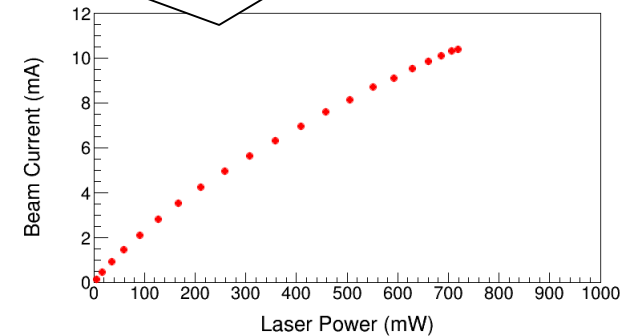

$$U(LP) \propto \sqrt{LP}$$

- For heavily Zn doped GaAs surface, $U(LP) \rightarrow 0$ (doping introduces high internal electric field to facilitate charge transport, increase diffusion length, and reduce chance of depolarization in active layer)

- Higher Gun HV suppresses photovoltage

MOLLER Injector Optimization

- Significant clipping of electron beam between photocathode and Hall can create excessive charge jitter or helicity correlated systematics on the beam. MOLLER requires very clean electron transmission from source to target with minimal beam interception. As a general rule, changes in mean value of charge asymmetry should be kept to less than 20 ppm, and width change less than 50 ppm, through injector and into hall (transmission of 95% can achieve this).
- MOLLER will use two Wien filters and Spin Solenoids to apply a spin rotation with a period of about 5-7 days. These are referred to as Flip-Right or Flip-Left settings. Preservation of beam properties under polarization reversal is key to utility of this flip.

MOLLER Transmission and Beam Noise

Beam Property	Required 1 kHz random fluctuations	Required cumulative helicity-correlation
Intensity	< 1000 ppm	< 10 ppb
Energy	< 110 ppm	< 1.4 ppb
Position	< 50 μm	< 0.6 nm
Angle	< 10 μrad	< 0.12 nrad

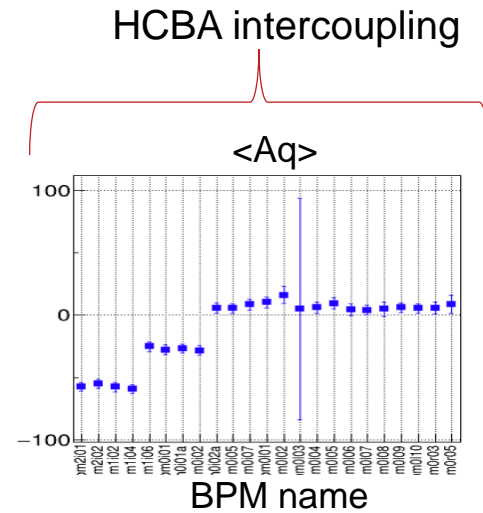
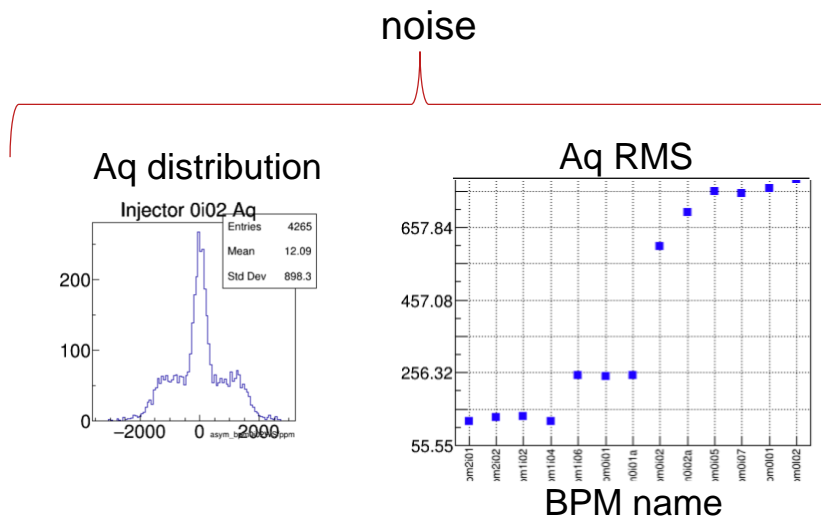

Poor beam transport can mess things up badly

MOLLER Wein Flip

Symmetry is required for position difference and beam size asymmetry cancellations

Injector

Hall A

Flip
Right:

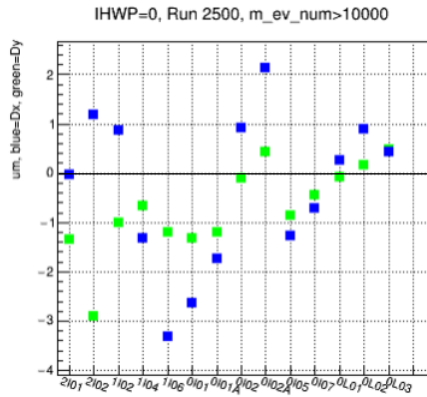

Flip
Left:

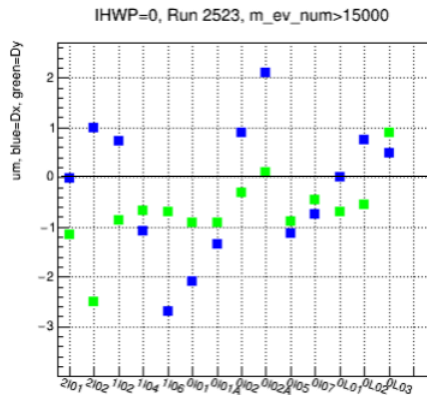

BPM name

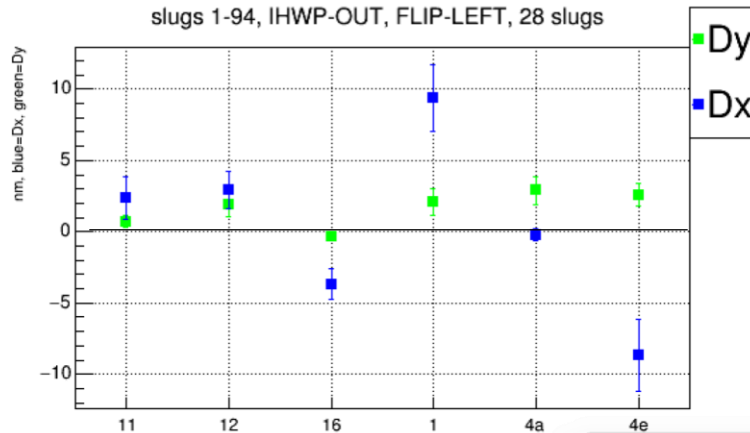
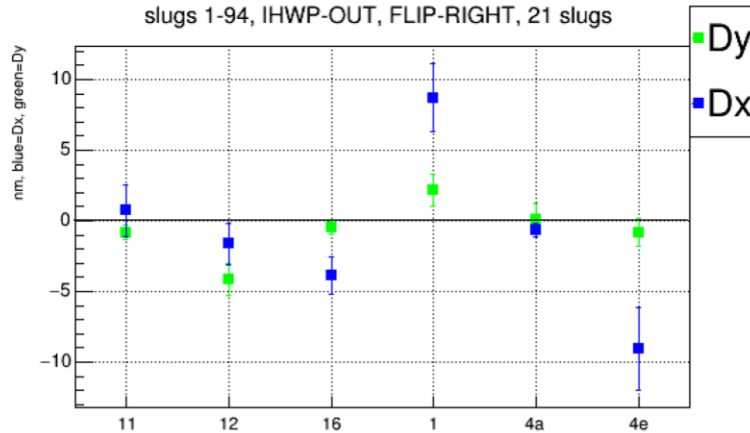

BPM name

Beam Loading

- Sub-harmonic Beam loading in Buncher and SRF cavities in Linacs?
 - Any changes to beam properties (e.g., energy spread)? Expected to be at 10^{-6} level in SRF cavities. Must be modeled and tested with beam.
 - Injector buncher cavities will be modeled and tested with beam

KLF Low-rep Laser (S. Zhang)



High Power (6 W) 1560 nm Fiber Amplifier

Technical Scheme and Key Components:

1. New 15.6/7.8 MHz LLRF system
2. A new high energy laser pulse fiber amplifier
3. Use Existing SHG (PPLN crystal) for 780 nm and rest of hardware downstream in D laser path
4. New Intensity Attenuator (IA) for charge feedback

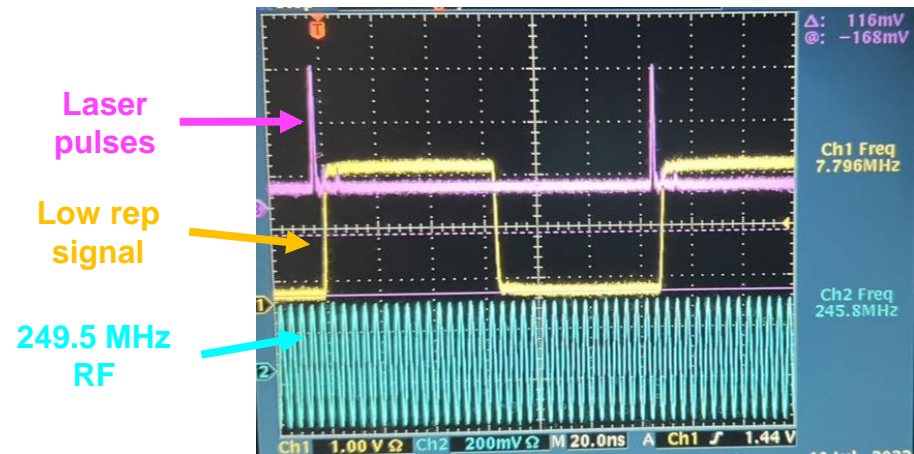
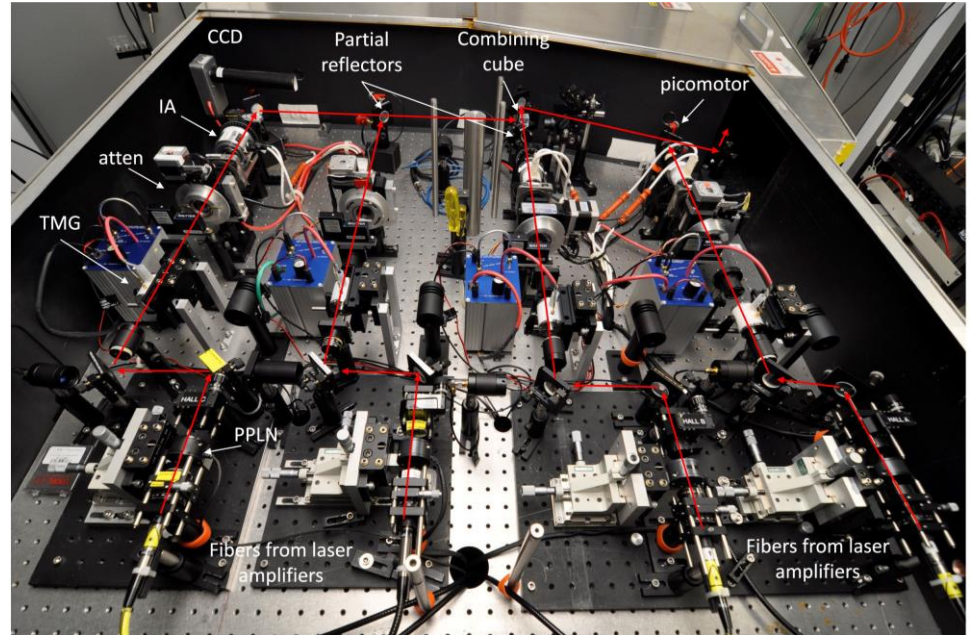

KLF Laser Status and Plans

- Present status:
 - A temporary RF sync system is assembled and tested (15.6/7.8 MHz RF signal by dividing 249.5 MHz by 16/32) providing stable phase at 15.6 and 7.8 MHz
 - A new laser amplifier is tested at both 15.6 and 7.8 MHz with enough power (factor of 10 than required)
 - EPICS control is ready
- Schedule:
 - Installation in Fall 2023

Laser Low-Level RF (LLRF)

- 15.6/7.8 MHz oscillation phase must be locked to accelerator 1497 MHz
- Existing LLRF system can provide two frequencies: 499 MHz and 249.5 MHz. It utilizes heterodyning concept, using two local oscillator signals locked to the accelerator's 499 MHz reference. This ensures that drive signals are always locked to variable frequency of CEBAF accelerator.
- To add a low-frequency drive signal of 15.6/7.8 MHz, we are designing a direct drive channel, which would provide full amplitude and phase control. To be ready by next Accelerator Shutdown.

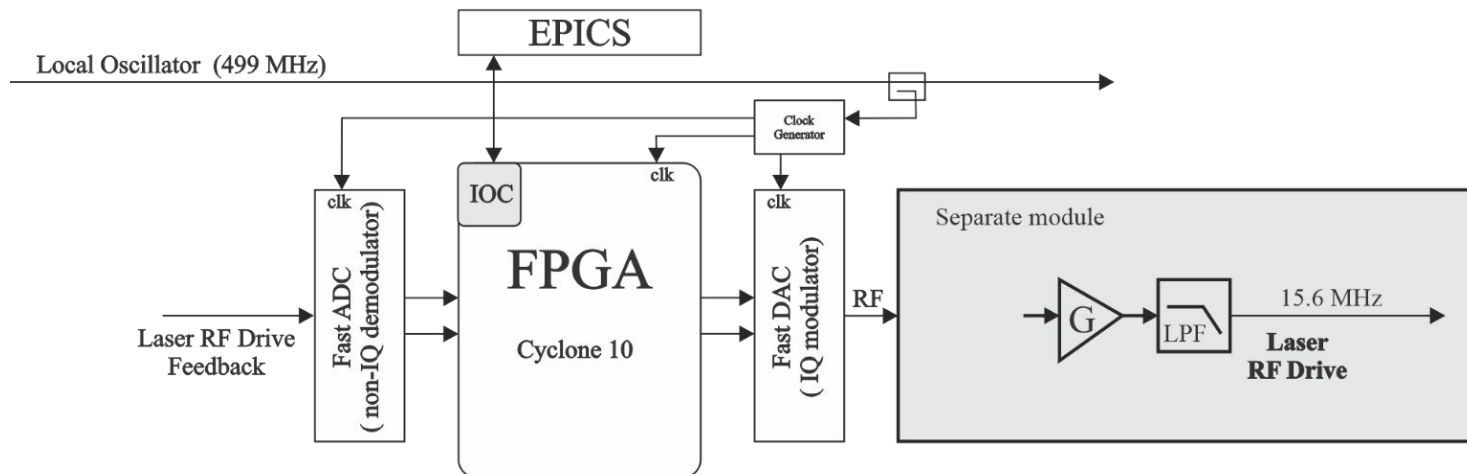

Schedule

Task	Date
Install laser Amp with temporary RF system	Fall 2023
Photocathode studies	Spring 2024
KLF charge feedback	Spring 2024
Injector optimization studies	Spring 2024
Beam loading in Injector bunchers	Spring 2024
Beam loading in SRF Linacs (model)	Fall 2023
Install complete LLRF system	Spring 2024
Beam loading in SRF Linacs (beam)	Spring 2024

Summary

- 0.32 pC @ 15.6 MHz (64 ns) likely to be OK
- Co-operation of KLF with MOLLER:
 - Photocathode effects
 - Requires charge asymmetry feedback on KLF beam
 - Injector will be optimized for MOLLER (not KLF)
 - Beam loading
- Must perform beam studies to explore all potential issues – must be completed by June 2024