



KL Flux Monitor

For the KLF collaboration

M. Bashkanov, D.P. Watts, N. Zachariou,
E.Chudakov, M. Amaryan, J. Ritman, J. Stevens, I. Strakovsky

K_L Flux Monitor Note

An accurate determination of the K_L beam flux is necessary to maximize the physics impact of the resulting data. To reach an accuracy of <5% in the determination of the K_L flux we plan to build a dedicated Flux Monitor (FM). This will provide a significant improvement over the typical 10% accuracy achievable from normalization of the data to previously measured reactions, for instance $K_L p \rightarrow K_S p$.

The operation of a K_L flux monitor could employ the regeneration of K_S and detection of $\pi^+\pi^-$ pairs in Pair Spectrometer as done at Daresbury [ref]. However this technique affects the quality of the resulting K_L beam. Therefore, a more effective choice for the FM at JLab would utilize in-flight decays of the K_L .

The K_L has four dominant decay modes [PDG]:

1. $K_L \rightarrow \pi^+\pi^-\pi^0$; BR = 12.54 %.
2. $K_L \rightarrow \pi^0\pi^0\pi^0$; BR = 19.52%.
3. $K_L \rightarrow \pi^\pm e^\mp \nu$; BR = 40.55%.
4. $K_L \rightarrow \pi^\pm \mu^\mp \nu$; BR = 27.04%.

All decay modes with two charged particles in the final state (1,3,4) can be used for flux determination. However, in this memo we will concentrate on a simplest one $K_L \rightarrow \pi^+\pi^-\pi^0$ where both charged particles have the same mass.

Flux monitor Location

To account for various possible acceptance effects during K_L beam propagation from the Be target, we plan to measure the K_L flux upstream of the GlueX detector, utilizing the Hall D Pair Spectrometer as a shielding against K_L which have decayed further upstream. As seen from the Figure 1, our current design of the FM fits between the Glue-X pair spectrometer magnet and the shielding wall very well.

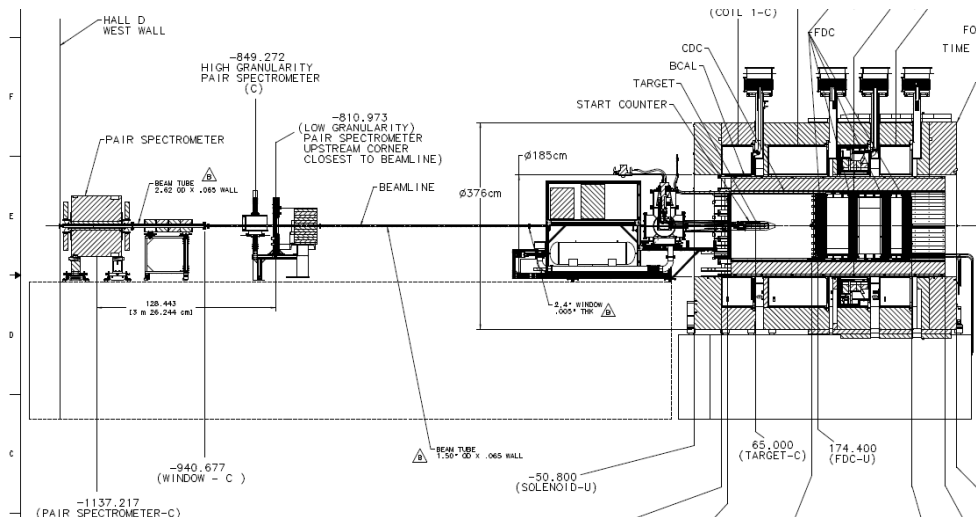

Flux Monitor

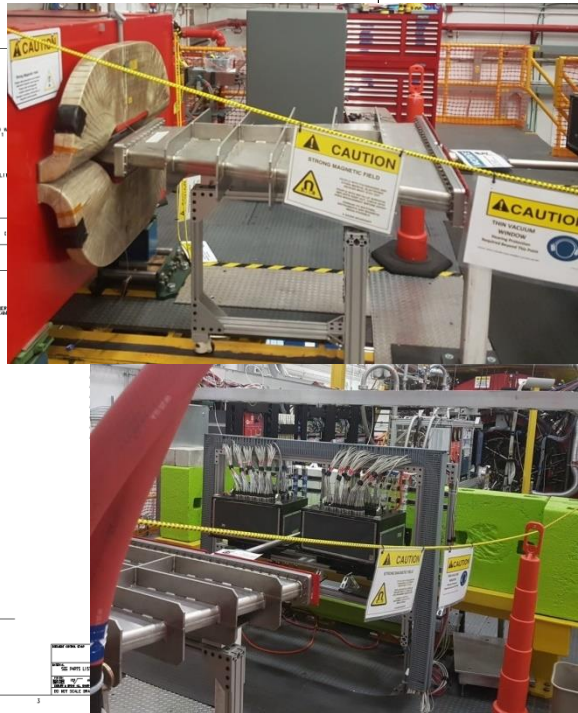
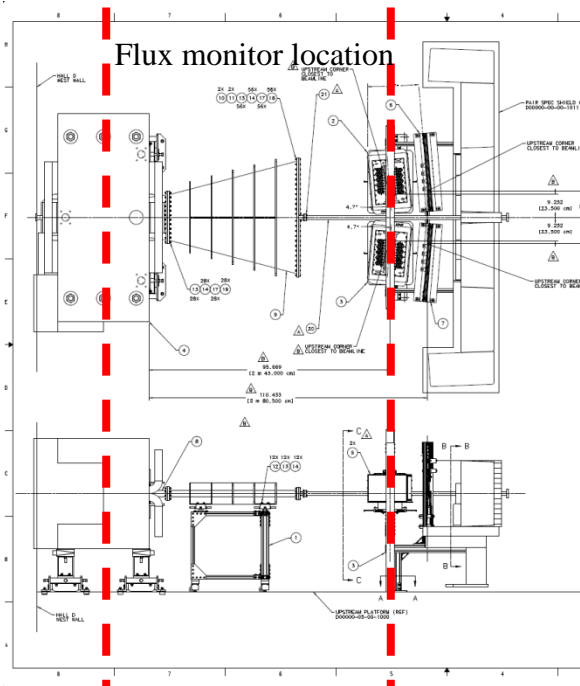
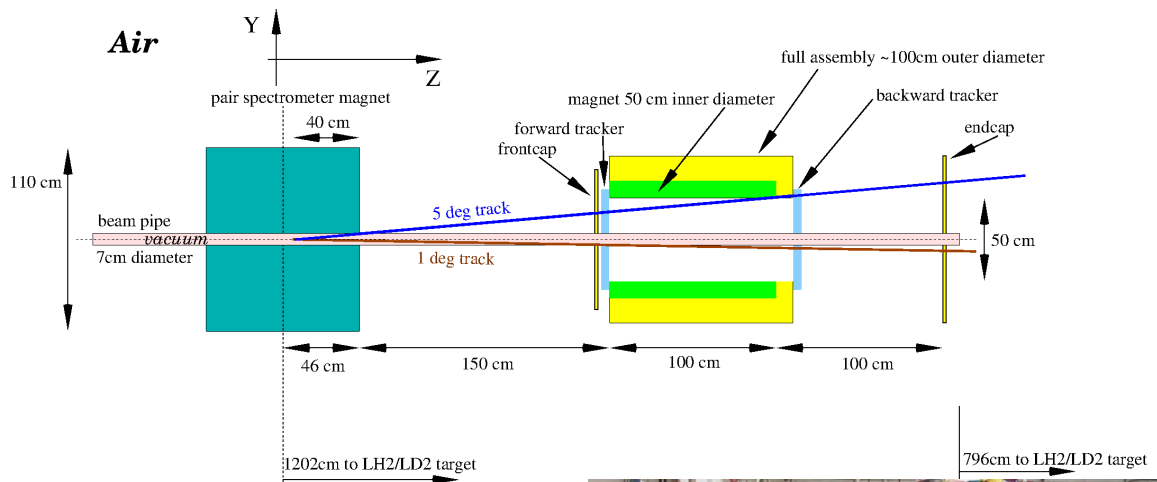

Figure 1 The FM location relative to Hall-D structures

Acceptance and dimensions of the Flux Monitor

All the K_L decay products are very forward peaked, but one needs to have sizable detectors to reconstruct K_L distributed along the length of the 24m beamline. The FM design proposed and described in this memo will measure a small fraction of decayed K_L 's, concentrating on the portion decaying within a distance of 2 meters downstream of the pair spectrometer magnet centre. To fulfill this requirement a detector system of roughly 50 cm diameter is sufficient. On Figure 2 one can see an acceptance for a 50 cm diameter system for various decay branches as a function of K_L beam momentum.

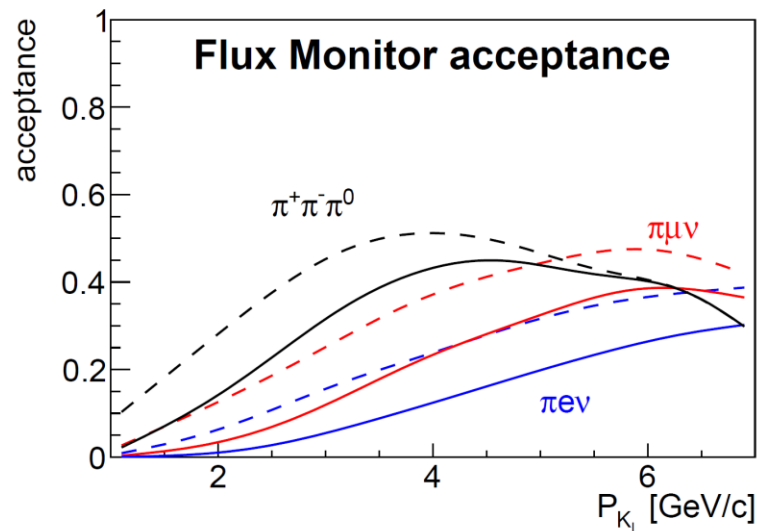

Figure 2 The FM acceptance for various K_L decay branches as a function of beam momentum. Solid lines correspond to a system with front/end-caps only. Dashed lines show the improvement achievable with an additional barrel part in the flux monitor design.

Figure 1 shows the achievable acceptance for flux monitor designs based on an endcap, with and without the inclusion of the barrel (see Figure 3). As evident from Figure 2, the main influence of the barrel part of the monitor would be to improve the FM acceptance at low kaon momenta. However, the 3π branch has sizable acceptance over the full range of K_L momenta even without barrel part. At high K_L momentum, interesting for the $K\pi$ -studies, the

barrel part does not provide any improvement in acceptance. From these considerations it was concluded that the barrel part is not crucial for successful operation of the flux monitor.

The flux monitor described in this memo consists of the following major parts shown on the Figure 3: the front cap, the forward tracker, the backward tracker, the endcap and a solenoidal magnet. Possible extension of the FM by a FM-start counter is under evaluation.

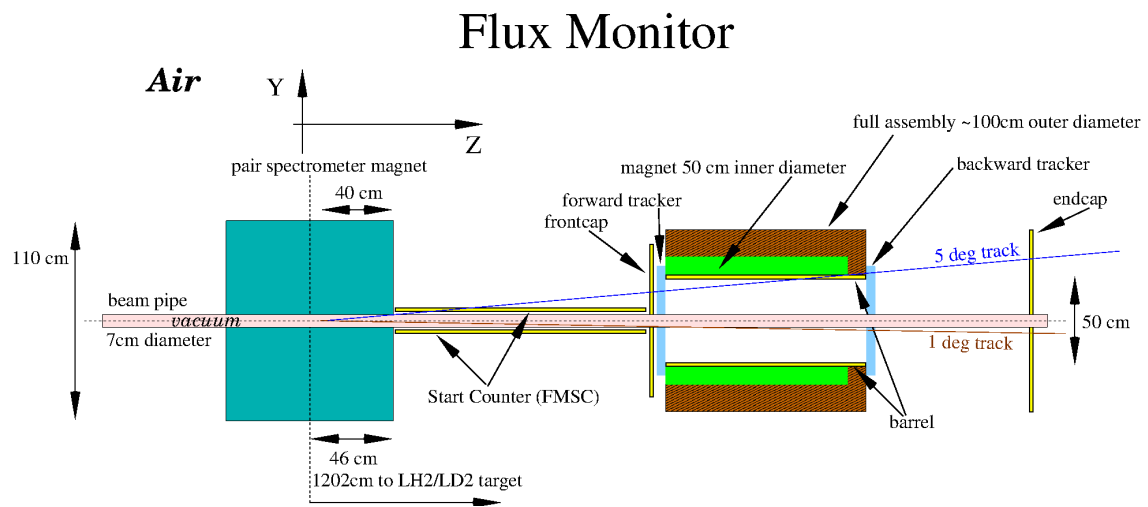

Figure 3: FM setup.

The front- and end-caps are pizza-piece shaped segmented plastic scintillator used to provide start and stop timing signals for time-of-flight (ToF) as well as signals for the trigger electronics. Each cap is proposed to have double-layer design to improve the time resolution and equipped with superior Hamamatsu R4998 PMTs (H6533 assemblies) with intrinsic 50 ps time resolution (PANDA FTOF prototype measurement). The performance of the FM ToF system is expected to be dominated by the TDC time resolution rather than PMT's.

A possible start counter (FMSC) would comprise plastic scintillator bars covering the beampipe, from the location of the pair spectrometer magnet to the FM magnet. A double-

sided FMSC readout would provide both vertex position (via time difference) and a start time.

The endcap would be located around 1 meter downstream of the FM magnet to improve the achievable ToF resolution.

Since the barrel was found to be unnecessary for successful operation the need for in-magnet tracking is eliminated, simplifying the operation of the monitor considerably. Two trackers will be installed outside the magnetic field covering the downstream and upstream needs of the FM. Both should have multi-layer design, enabling independent θ, ϕ reconstruction of charged particles in the FM. The K_L decay vertex position can be determined by the upstream tracker, combined with θ information on the particles after they leave the solenoidal field from the downstream tracker. The ϕ angle displacement between the forward and backward trackers provides measurement of the momentum of the decay products.

KL Flux determination

The Kaon flux has a complex dependence on momentum, transverse position and distance from the Be-target. Due to the $1/Z^2$ solid angle suppression (here Z is the distance from the Be target), the FM would see 4 times more kaons than the LH2/LD2 cryogenic target. Also some kaons can decay on the way to the LH2/LD2 target within Glue-X. The flux suppression factor due to K_L decay is equal to $f(\beta) = e^{-\frac{Z}{c\tau\beta\gamma}}$, where $c = 29.9 \text{ cm/ns}$ is the speed of light, $\tau = 51 \text{ ns}$ is the K_L mean lifetime; $\beta = v/c$ – kaon velocity in units of speed of light; $\gamma = \frac{1}{\sqrt{1-\beta^2}}$. Because of these dependencies accurate flux monitoring requires determination of the kaon flux as both a function of transversal position within the beampipe and Kaon energy. The most inner 3cm of the transverse beam profile at the position of the

FM would correspond to a 6cm profile at the LH2/LD2 target. A 7cm beam pipe diameter allows sufficient margins and the clean definition of a fiducial regions of the transverse beam profile at the FM position. One should also keep in mind that the radial extension of the kaon beam varies with kaon momentum – fast kaons tend to be more focused due to the larger Lorentz boost. All in all we expect to measure about 1.1k Kaon/s in the FM.

In the Figure 4 one can see the Kaon flux experienced by the FM and by the LH2/LD2 target respectively. The increased low momentum yield of Kaons observed in the FM compared to the target position arises because these low momenta particles have a larger possibility of decaying in the region between the FM and target.

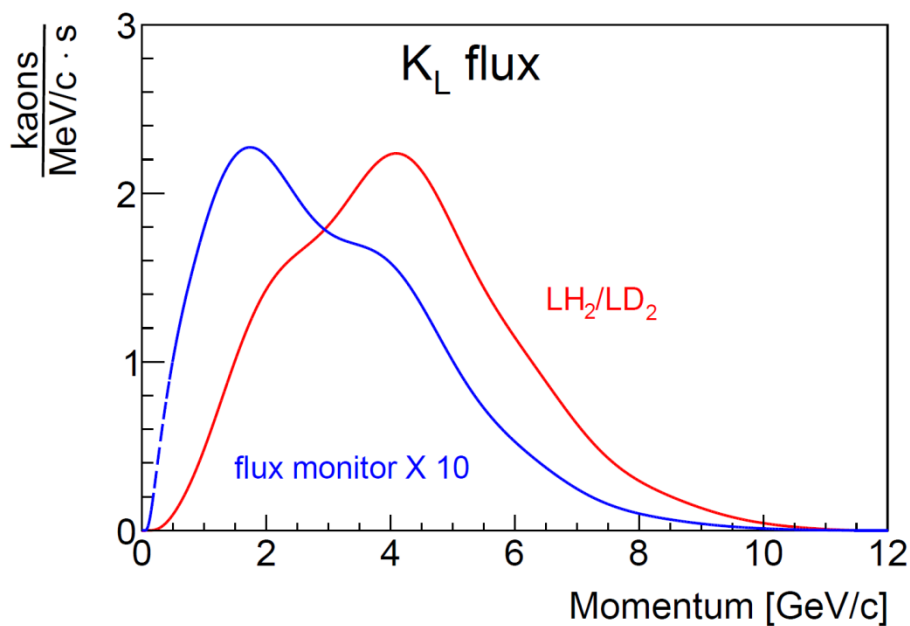

Figure 4 Kaon flux at LH2/LD2 target (red) and at FM (blue). The yield of events from the FM is multiplied by 10.

To be measured by the FM, both charged particles from the kaon decay need to be incident within the FM acceptance, see Figure 2. Taking into account the different branching

ratios, we expect to reconstruct the following number of K_L from various decay channels, see Figure 5.

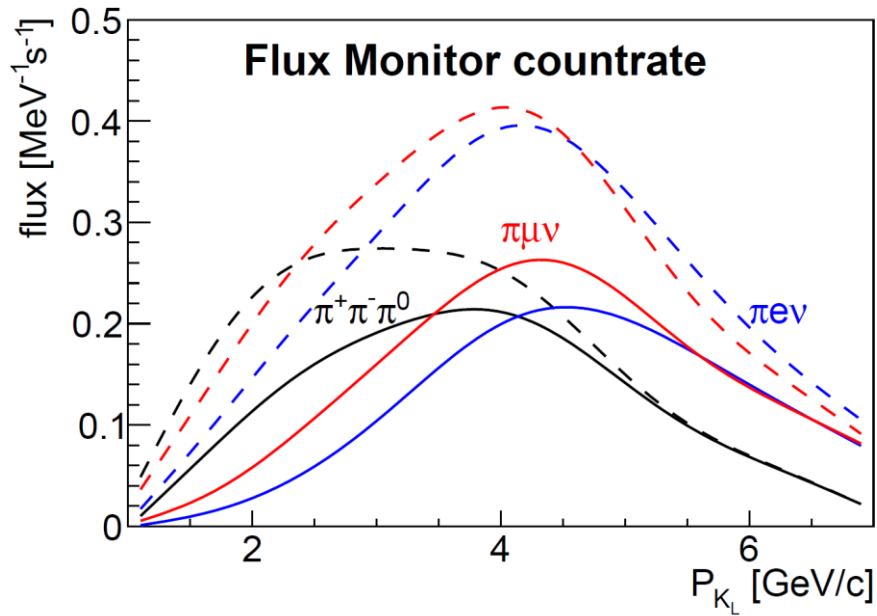

Figure 5. Visible K_L flux for various decay channels within the FM acceptance. Solid lines correspond to a system with front/end-caps only. Dashed lines show the improvement one can obtain with the additional barrel part extension to the FM.

One can quantify the expected rate in terms of the achievable statistical error within a one day measurement (Figure 6 left) and the number of days measurement required to get a 1% statistical accuracy in flux (Figure 6 right) for a 20 MeV/c bins in K_L momentum in case of $\pi^+\pi^-\pi^0$ branch analysis.

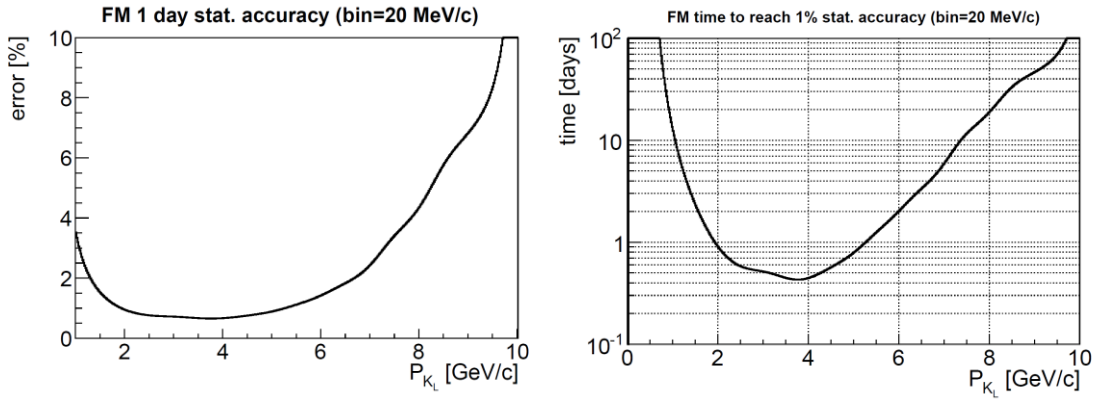

Figure 6. Expected statistical accuracy for 1 day FM measurement (left) and time to reach 1% accuracy (right) for 20 MeV/c bins in K_L momentum and $\pi^+\pi^-\pi^0$ decay branch.

For the kaon beam momenta range appropriate for the hyperon programme a 1% statistical error of the K_L flux determination is achievable in less than a day.

Vertex Position Reconstruction

To reconstruct the spatial distribution of the K_L flux within the beam pipe as well as to determine the K_L time-of-flight from the Be-target, a K_L decay vertex position reconstruction is required. The accuracy of vertex reconstruction solely depends on accuracy of the tracking modules. At the moment it is not clear which modules will be used. We are currently trying to get trackers from one of the decommissioned experiments (e.g. Juelich/COSY). Therefore, we assume various module performances in our simulations. We have assumed that each module is made of two layers with a distance between layers of 5 cm and each layer has the ability to determine the X-Y position with an accuracy d (a simplified representation of typical X-Y-V-W wire/straw chamber arrangements). The vertex position in the transverse plane is largely defined by the forward tracker, since the magnetic field skews tracks. However, the magnetic field does not change the polar angle (θ), hence the position along the beam direction is largely defined by the forward-backward tracker difference. In our resolution studies we performed a two-track fit, assuming a common vertex, rather than

making simultaneous track fits with vertex extraction from the distance of closest approach of the tracks. In the no-magnetic field mode (ToF mode) both trackers contribute to the achievable transverse position resolution. The position resolution changes with distance and polar angle (the closer to the tracker and the higher angle – the better the resolution). On average, one can say that K_L position resolution in the transverse plane is about $2 \cdot d$ and in the longitudinal direction $\sim 20 \cdot d$, where d is the single plane tracker resolution. Even a 1 mm tracker resolution should be tolerable. A typical $200 \mu\text{m}$ tracker resolution would be more than adequate for this application.

Decay reconstruction.

From design experience of a similar time counter detector at Wasa (2 layers, pizza pieces, 37 mm inner radius, 394 mm outer radius (150 cm larger than FM pizzas)) we can conclude that a $\sqrt{2}$ factor from employing a double-layer design largely compensates all geometrical/scintillator factors, making the achievable ToF resolution comparable to the resolution of a single PMT. This statement is valid under the assumption of negligibly small electronics-related time resolution. Using electronics similar to the PANDA time-of-propagation Disc DIRC achieving 50 ps time resolution seems to be feasible. This resolution is assumed in our simulations. The K_L decay vertex time resolution defines the achievable momentum resolution. We expect it to be better than a single track/single cap time resolution, but for our simulations we have assumed conservative 50 ps. One of the requirements to the FM time resolution is that it should be better than the GlueX Start Counter timing due to the 2 times shorter time-of-flight baseline of the FM compared to GlueX. This condition can be easily fulfilled since the FM PMT resolution is 5 times better than the SC, the FM has two tracks and therefore 4 time stamps (8-time stamps per event) instead of 1 for SC.

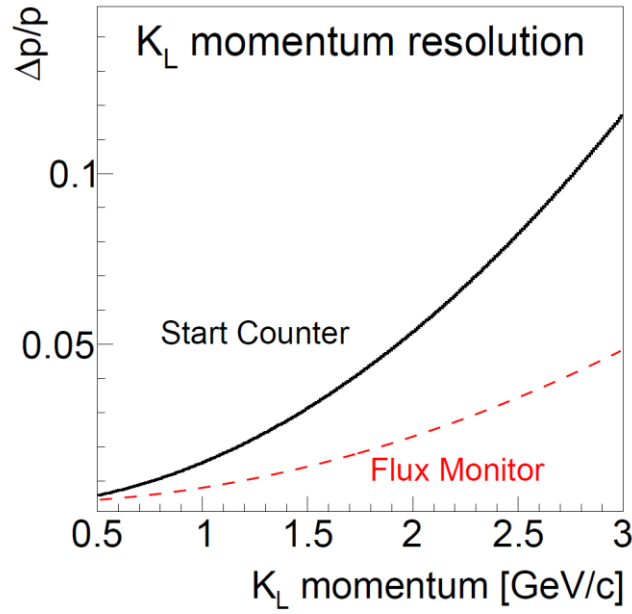

Figure 7 SC and FM momentum resolution under assumption of 250 ps and 50 ps time resolutions respectively.

The momentum resolution in a solenoidal magnetic field is fully determined by the tracker resolutions. The ϕ displacement in solenoidal magnetic field is equal to $\phi' = \frac{l \cdot z \cdot 0.3 \cdot B}{p \cdot \cos(\theta)}$, where l is the length of the magnet [m], B is magnetic field strength [T], z is the particle charge and p is momentum[GeV/c]. For the $l = B = z = 1$ we have $\phi' = \frac{0.3}{p \cdot \cos(\theta)}$. For the small polar angles ($\theta < 5^\circ$), $\cos(\theta) \sim 1$ we have $\phi' = \frac{0.3}{p}$. The Magnetic field only acts on the transversal momentum component. For low angle particles the transverse component is small, and the effect is large. However the overall size of the deflection depends on the time in the magnetic field. This time is determined by the length of solenoid and the longitudinal component of momentum. For a typical momentum of 1 GeV/c and a 5 degree polar angle a ϕ displacement of 17 degrees is expected, or a 7.5cm displacement along the arc. For a 1 GeV/c and 1 degree polar angle a ϕ displacement would be the same (17 degrees), but the linear displacement along the arc would be reduced to 1.5 cm. Despite these deficiencies a magnetic field momentum reconstruction is expected to work a lot better than the ToF

reconstruction. The expected performance of ToF and magnetic reconstruction is illustrated in figure 7 below.

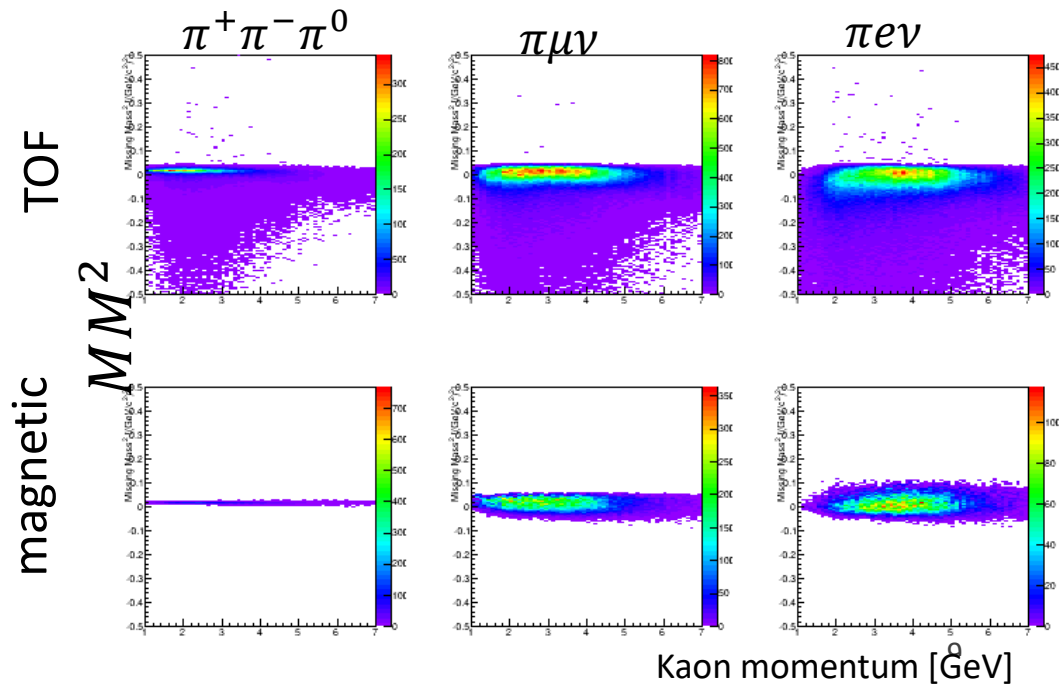

Figure 8 Missing mass reconstruction with ToF and Magnet as a function of kaon momentum. All charged particles in all decay channels are assumed to have mass of pion.

Correct mass assignment for the $\pi^+\pi^-\pi^0$ branch give a much narrower MM distribution. A 1-Dimensional projection to the y-axis, as shown in Figure 9 allows a direct comparison of various case scenarios.

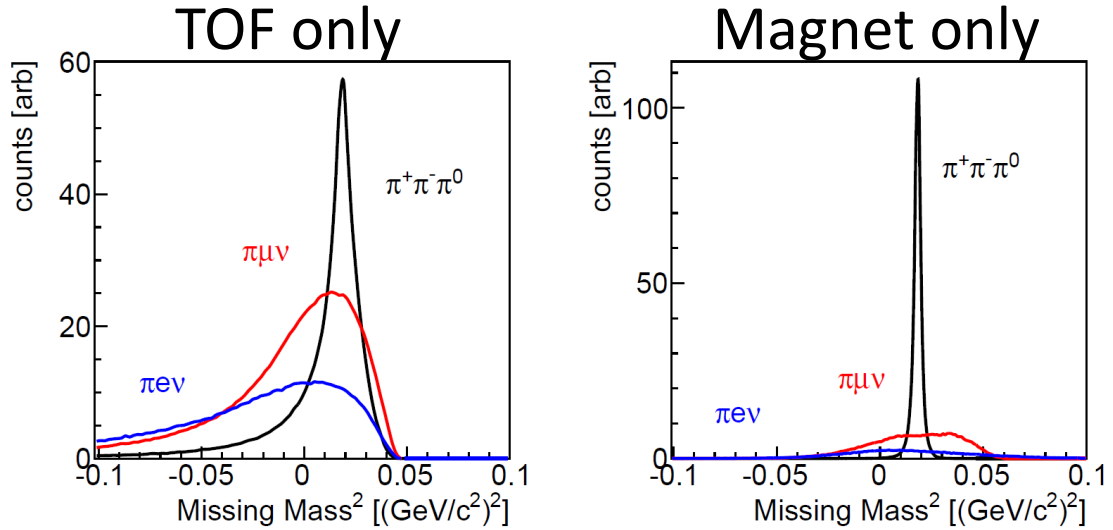

Figure 9 Missing mass squared for the ToF and magnetic reconstruction of kaon decay.

The ratio between different branches is fixed. So in absence of background even ToF reconstruction is sufficient. In the presence of any unknown background an extra rejection condition or particle identification technique (β/p) would be useful. As expected, the magnetic field provides more precise event reconstruction.

Magnet

The construction of a high precision K_L Flux Monitor would require a 1 m long, 50 cm diameter solenoidal magnet with 1 T magnetic field. We have contacted “Tesla magnet division” (www.tesla.co.uk) to investigate the possible options and obtain first costings. The company is well established and renowned for their manufacture of a range of MRI magnets which are reliable and designed to be operated without major supervision. They also manufacture resistive magnets.

- 1) Type of magnet. Four possible types of magnets were considered (one resistive and 3 superconductive):
 - a. **Resistive.** Will be very expensive and can hardly be manufactured due to such a large opening (50cm) at 1T field
 - b. **Zero-boiloff.** The coil would be submerged in a liquid helium bath, and any liquid boiling off (e.g. due to a heat leak into the cryostat) would be

recondensed into liquid by a cryorefrigeration system (cold-head). This is typically how modern superconducting magnets are operated. They require service to the cold-head about every 2-3 years, and consume very little helium over their lifetime.

- c. **Regular helium bath.** The coil would be submerged in a liquid helium bath, and any liquid boiling off due to heat leak into the cryostat would be lost to the outside. These magnet designs require a regular top-off of the liquid and hence have a higher operating cost due to the helium consumption. This method is typically only used for short runs in experiments where the magnet would be run for a few days and then turned off. **Not recommended for continuous operation.**
- d. **Cryogen-free.** The magnet would contain **no liquid helium or other cooling medium**, but would instead be cooled by thermal conduction only, from a cryo-refrigerator. This type of system only requires power to operate, hence in the long term is cheaper to operate. Conversely they take longer to cool down during installation. If the experiment is continuously running this might be the most cost-optimal approach.

Since maintenance, long term reliability and operational costs are of our highest concerns option (d) was chosen as being most suitable for the project. As a downside it requires **5 days to cool it down** to operational temperature. The cooling time is tolerable considering the advance notice and reliability of beamtime scheduling at JLab.

- 2) Two options of passive/active shielding were considered. Since we do not have a limitation in space/weight and do not plan to vary the magnetic field during the run, a **passive iron shielding** was selected. The installation of the shielding would require crane lifting. Such facilities are available in the hall.
- 3) Shimming. Since we do not plan to alternate the flux monitor to add or remove material from the magnet active area, we choose **passive shimming**.

The selected magnet design would have the following characteristics:

- Field: 1 T
- Room temperature bore: 500 mm
- Magnet length: 1000 mm
- Cryostat length 1200 mm
- Homogeneity: <1% over 540 mm
- Stray field (5 gauss): 3.6 m radial x 4.6m axial from magnet centre

- Current: 300 amps
- Fixed current leads
- Cooling: conduction cooled
- Cryocooler: Sumitomo RDK408D2
- Power supply and control electronics included.
- Cool-down time: 5 days from room temperature
- Overall weight: 1100 kg. The magnet will be shipped in one piece in assembly with the shielding and cryostat. It will be equipped with connectors for crane lifting and with skates to move around.
- The overall cost of the project was estimated to be 362.000 GBP, including electronics (essentially including everything but installation work).

Neutron Background

We do not expect any influence of a neutron background on the FM. A similar system of ToF scintillators with trackers was working at the WASA detector for a decade under several orders of magnitude higher neutron fluxes without showing signal deterioration. Conventional PMT's proved to be very tolerable to a neutron flux. We also do not expect any neutron flux mediated disturbances in kaon flux measurements. At the position of the FM assembly the neutron flux is more or less confined within the beam pipe. However, the divergence of a neutron beam will cause some charge particle background, which would be seen by the FM. In some cases, like two-proton knockout or $nn \rightarrow pn\pi^-$ reactions in the beam pipe material these events might mimic kaon decays. Fortunately, all these events would originate from the beampipe with a vertex displacement of a 35 mm in transversal direction, allowing a fair separation from useful kaon decays limited by 15 mm transverse displacement. The FM tracker system will provide sufficient accuracy to disentangle these cases with simple fiducial cuts.

One also needs to take into account that kaons and neutrons are largely separated in time, see Figure 10. Neutron in tails from previous bunches are too slow to produce two charge tracks reactions which can be misidentified with kaons. So in reality we need to care about a lot less neutrons which have similar velocities to kaons but with vertex reconstruction and missing mass determination such events can be eliminated.

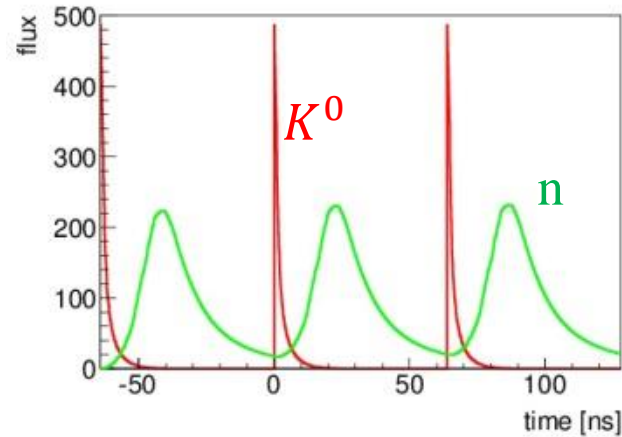

Figure 10 Time structure of kaon and neutron fluxes

Costs

As soon as the KLF proposal accepted or at least conditionally approved by the JLab advisory committee, the nuclear physics group of the University of Edinburgh (along with other UK collaborators) plans to apply for a UK(STFC) grant to cover around 500kGBP of the direct equipment costs including the magnet and other major parts of the KLFlux Monitor and 250kGBP personnel costs (750kGBP combined).

We have evaluated possible cost of the ToF and magnetic parts of the FM assembly. Several options are considered for the trackers:

- 1) Used trackers from decommissioned experiments, e.g Wasa FPC (forward proportional chamber) which is currently in use for the JEDI experiment
- 2) Manufacturing of a new tracker:
 - a. Straw-Tube tracker. Juelich design (COSY-TOF/Panda). Four double layer one each side of the magnet
 - b. Drift chambers ODU design, (CLAS)
 - c. Micromegas tracker, same design and nearly the same dimensions as CLAS
 - d. Manufacturing of the wire chambers in on of the UK universities.

The final decision on a trackers side is pending. If the reuse option will be realized it might save about 200kGBP on tracker construction.

Additional costs for accommodation of the Hall-D infrastructure to a FM need were evaluated to be about \$5k for the cooling system and \$3k for electrical infrastructure.

Expected cost can be summarized in a table

Item	Price per unit [GBP]	Cost [GBP]
Magnet	362000	362000
Scintillating material	2000	2000
Hamamatsu H6533 (24 units)	1700	40800
Trackers	TBD	
Electronics	TBD	
Hall-D infrastructure		<15000

Summary

The K_L flux determination with proposed Flux Monitor and accuracy better than 5% over the full range of energies seems to be feasible. The construction is straightforward and can be completed within 1 year. No prototyping is necessary. The achievable reconstruction resolution would be determined by the tracking system and TDC electronics. The overall cost of the FM construction seems to be affordable. No interference with existing Hall-D equipment is expected.