

# ***Strange Meson Spectroscopy with KLF at JLab***



*Moskov Amaryan*

*Old Dominion University  
Norfolk, VA, USA*

***MIAPP Workshop, Munich, Germany, October 11, 2019***

## Proposal for JLab PAC47

Strange Hadron Spectroscopy with Secondary  $K_L$  Beam in Hall DExperimental Support:

S. Adhikari<sup>35</sup>, M. J. Amaryan (**Contact Person, Spokesperson**)<sup>35</sup>, A. Austregesilo<sup>39</sup>,  
M. Baalouch<sup>42</sup>, M. Bashkanov (**Spokesperson**)<sup>57</sup>, V. Baturin<sup>35</sup>, V. V. Berdnikov<sup>52,32</sup>, T. Black<sup>55</sup>,  
W. Boeglin<sup>30</sup>, W. J. Briscoe<sup>53</sup>, V. D. Burkert<sup>33</sup>, E. Chudakov<sup>33</sup>, P. L. Cole<sup>3</sup>, O. Cortes-Becerra<sup>53</sup>,  
V. Crede<sup>45</sup>, D. Day<sup>12</sup>, P. Degtyarenko<sup>33</sup>, S. Dobbs (**Spokesperson**)<sup>45</sup>, G. Dodge<sup>35</sup>,  
A. G. Dolgolenko<sup>31</sup>, H. Egiyan<sup>33</sup>, P. Eugenio<sup>45</sup>, S. Fegan<sup>51</sup>, A. Filippi<sup>49</sup>, S. Furletov<sup>33</sup>, L. Gan<sup>55</sup>,  
A. Gasparyan<sup>20</sup>, G. Gavalian<sup>33</sup>, D. I. Glazier<sup>19</sup>, V. S. Goryachev<sup>31</sup>, L. Guo<sup>30</sup>, A. Hayrapetyan<sup>18</sup>,  
G. M. Huber<sup>50</sup>, A. Hurley<sup>54</sup>, C. E. Hyde<sup>35</sup>, I. Illari<sup>51</sup>, D. G. Ireland<sup>19</sup>, K. Joo<sup>44</sup>, V. Kakoyan<sup>56</sup>,  
G. Kalicy<sup>52</sup>, M. Kamel<sup>30</sup>, C. D. Keith<sup>33</sup>, C. W. Kim<sup>51</sup>, G. Krafft<sup>33</sup>, S. Kuhn<sup>35</sup>, S. Kuleshov<sup>43</sup>,  
A. B. Laptev<sup>28</sup>, I. Larin<sup>1</sup>, D. Lawrence<sup>33</sup>, D. I. Lersch<sup>45</sup>, W. Li<sup>54</sup>, V. E. Lyubovitskij<sup>49,46,47,51</sup>,  
D. Mack<sup>33</sup>, D. M. Manley<sup>27</sup>, H. Marukyan<sup>56</sup>, V. Matveev<sup>31</sup>, M. McCaughan<sup>33</sup>, B. McKinnon<sup>19</sup>,  
C. A. Meyer<sup>39</sup>, F. Nerling<sup>16,14</sup>, G. Niculescu<sup>22</sup>, A. Ostrovidov<sup>45</sup>, Z. Papandreou<sup>40</sup>, K. Park<sup>33</sup>,  
E. Pasyuk<sup>33</sup>, L. Pentchev<sup>33</sup>, W. Phelps<sup>53</sup>, J. W. Price<sup>11</sup>, J. Reinhold<sup>30</sup>,  
J. Ritman (**Spokesperson**)<sup>7,25</sup>, D. Romanov<sup>32</sup>, C. Salgado<sup>34</sup>, T. Satogata<sup>33</sup>, A. M. Schertz<sup>54</sup>,  
S. Schadmand<sup>25</sup>, D. I. Sober<sup>52</sup>, A. Somov<sup>33</sup>, S. Somov<sup>32</sup>, J. R. Stevens (**Spokesperson**)<sup>54</sup>,  
I. I. Strakovsky (**Spokesperson**)<sup>53</sup>, V. Tarasov<sup>31</sup>, S. Taylor<sup>33</sup>, A. Thiel<sup>19</sup>, D. Watts<sup>57</sup>,  
L. Weinstein<sup>35</sup>, D. Werthmüller<sup>57</sup>, T. Whitlatch<sup>33</sup>, N. Wickramaarachchi<sup>35</sup>, B. Wojtsekhowski<sup>33</sup>,  
N. Zachariou<sup>57</sup>, J. Zhang<sup>12</sup>

Theoretical Support:

A. V. Anisovich<sup>8,15</sup>, A. Bazavov<sup>13</sup>, R. Bellwied<sup>24</sup>, V. Bernard<sup>38</sup>, G. Colangelo<sup>4</sup>, A. Cieply<sup>41</sup>,  
M. Döring<sup>53</sup>, S. Eidelman<sup>36,37</sup>, A. Eskandarian<sup>53</sup>, J. Goity<sup>33,21</sup>, H. Haberzettl<sup>53</sup>,  
M. Hadžimehmedović<sup>50</sup>, R. L. Jaffe<sup>10</sup>, B. Z. Kopeliovich<sup>51</sup>, H. Leutwyler<sup>4</sup>, M. Mai<sup>53</sup>,  
V. Mathieu<sup>29</sup>, M. Matveev<sup>15</sup>, U.-G. Meißner<sup>8,26</sup>, V. Mokeev<sup>33</sup>, C. Morningstar<sup>39</sup>,  
B. Moussallam<sup>38</sup>, K. Nakayama<sup>2</sup>, V. Nikonov<sup>8,15</sup>, Y. Oh<sup>59</sup>, R. Omerović<sup>50</sup>, H. Osmanović<sup>50</sup>,  
J. R. Pelaez<sup>29</sup>, A. Pilloni<sup>33</sup>, D. Richards<sup>33</sup>, D.-O. Riska<sup>23</sup>, A. Rodas<sup>29</sup>, J. Ruiz de Elvira<sup>4</sup>,  
H.-Y. Ryu<sup>9</sup>, E. Santopinto<sup>17</sup>, A. V. Sarantsev<sup>8,15</sup>, J. Stahov<sup>50</sup>, A. Švarc<sup>58</sup>, A. Szczepaniak<sup>6,33</sup>,  
R. L. Workman<sup>50</sup>, B. Zou<sup>5</sup>,

<sup>1</sup> University of Massachusetts, Amherst, MA 01003, USA<sup>2</sup> University of Georgia (UGA), Athens, GA 30602, USA<sup>3</sup> Lamar University, Beaumont, TX 77710, USA<sup>4</sup> University of Bern, CH-3012 Bern, Switzerland

# **Outline**

## ***Future Prospects with $K_L$ Facility at JLab***

- *Electron Beam*
- *Compact Photon Source*
- *Be Target*
- *Flux Monitor*
- *$K_L$  Beam*
- *$LH_2/LD_2$  Target*

## ***Strange Meson Spectroscopy***

- *Current Status and Future Prospects*

## ***Summary***

# Hall-D beamline and GlueX Setup

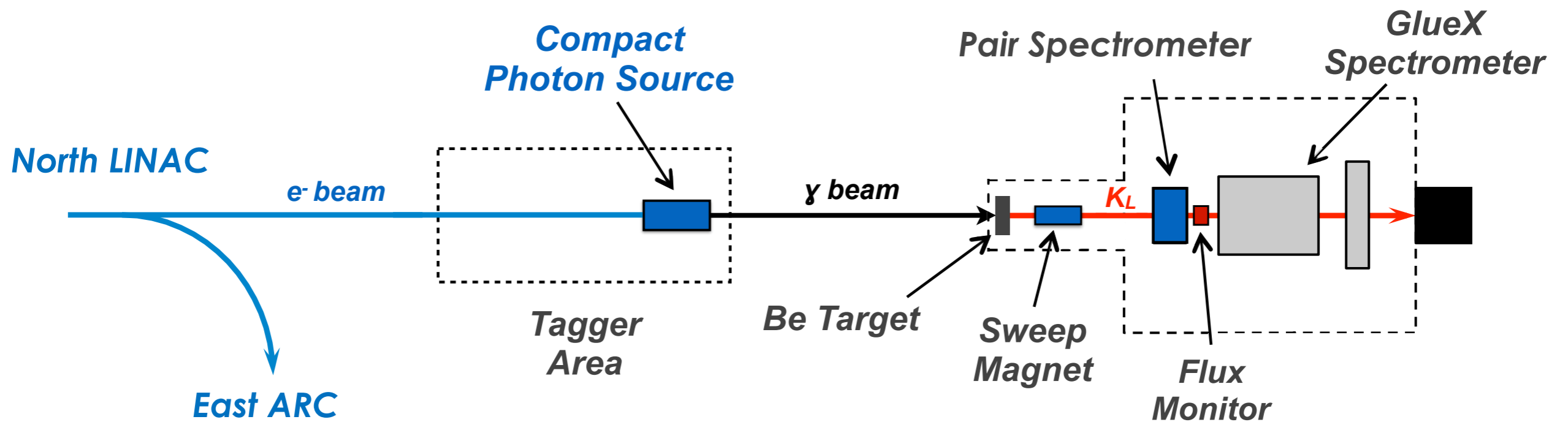

## *Electron Beam Parameters*

$$E_e = 12 \text{ GeV} \quad I = 5 \mu\text{A}$$

$$\text{Bunch spacing} \quad 64 \text{ ns}$$

*No major problems.*

**Doable !**

**Confirmed by accelerator experts**

# Compact Photon Source

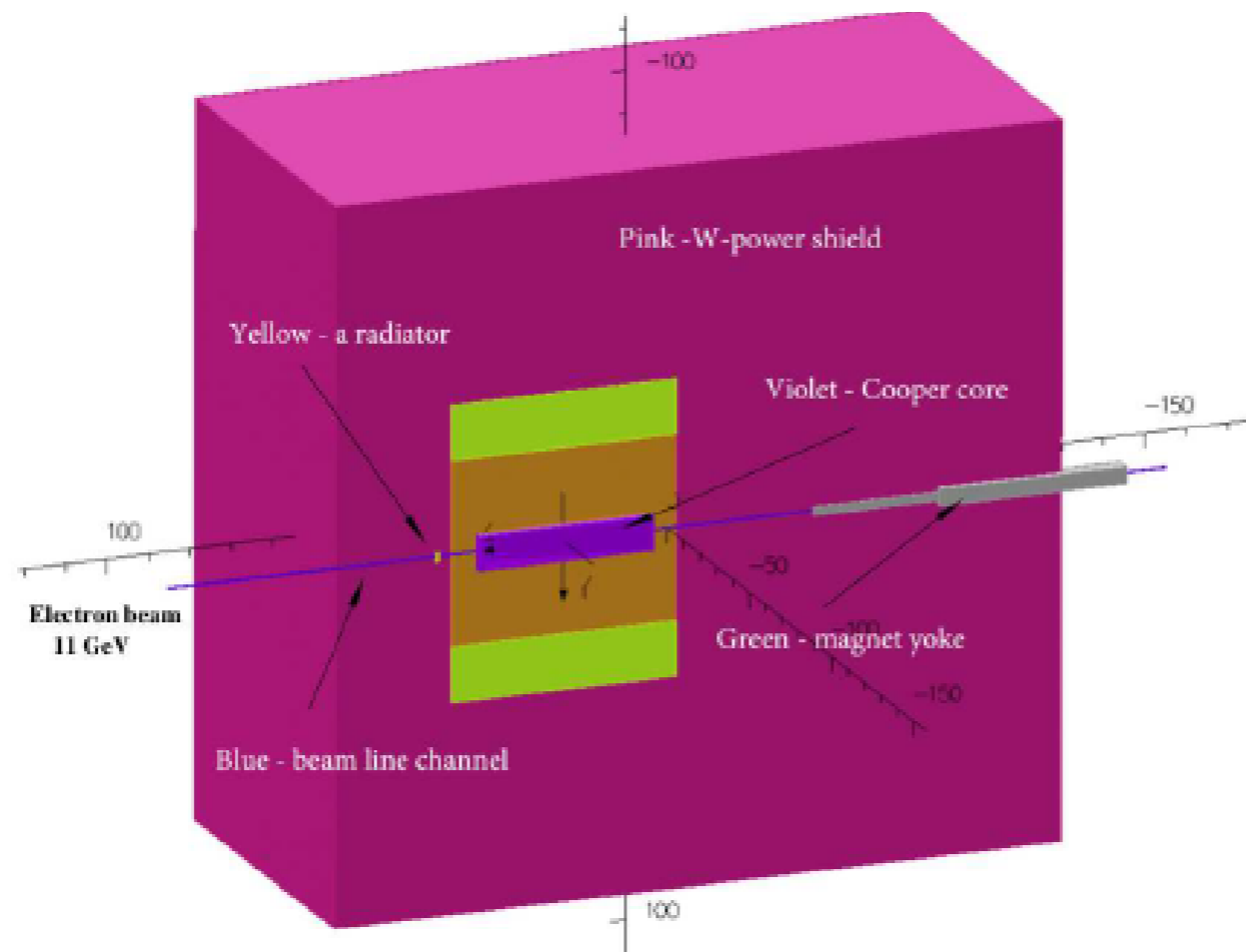

**Conceptual design is completed for Halls A&C**

**The details of the CPS are designed by the CPS Collaboration**

**Meets RadCon Radiation Requirements**

# Be Target Assembly: Conceptual Design

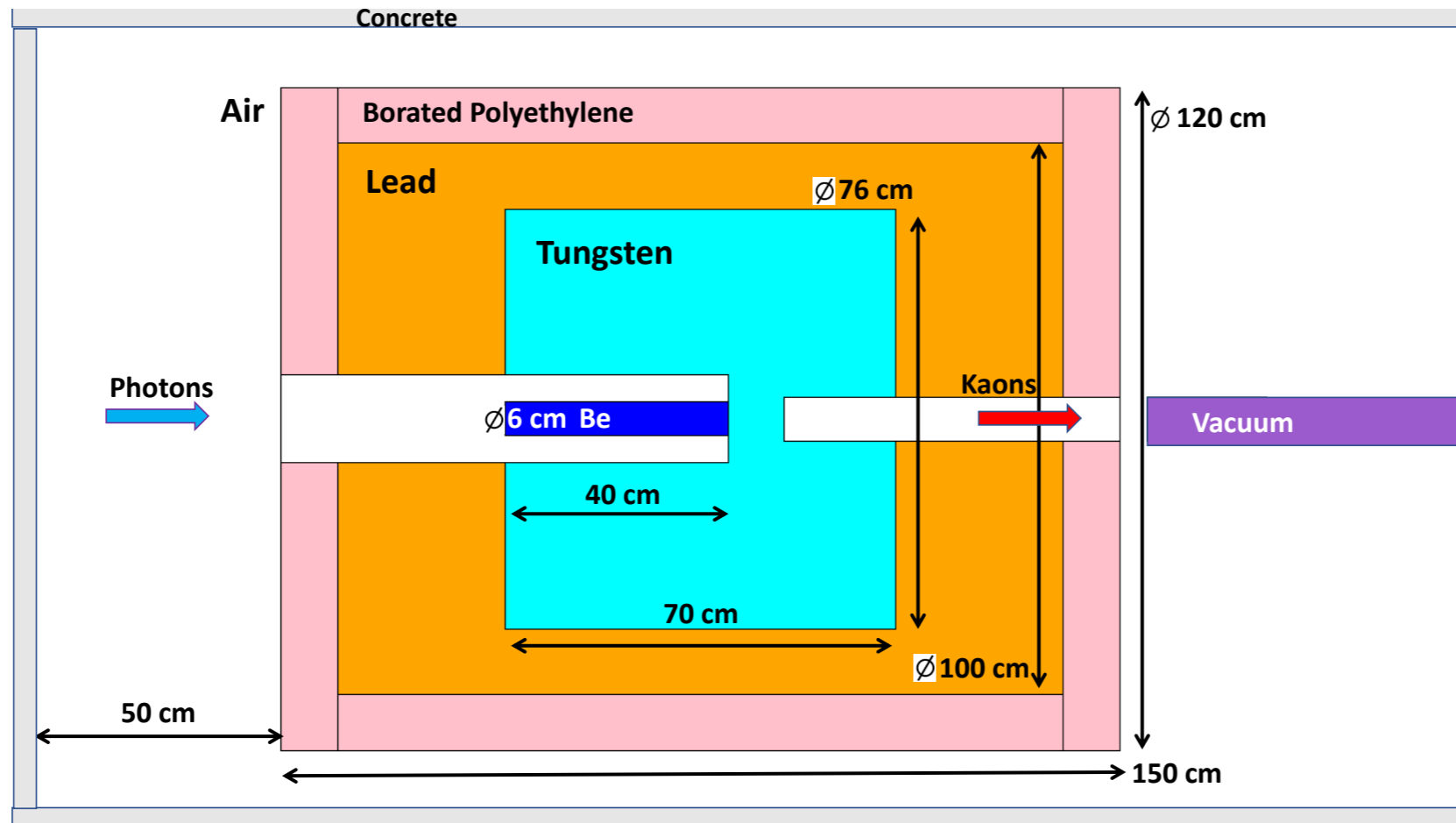

-Meets RadCon Radiation Requirements

-Conceptual Design Endorsed by Hall-D Engineering Staff

# Flux Monitor

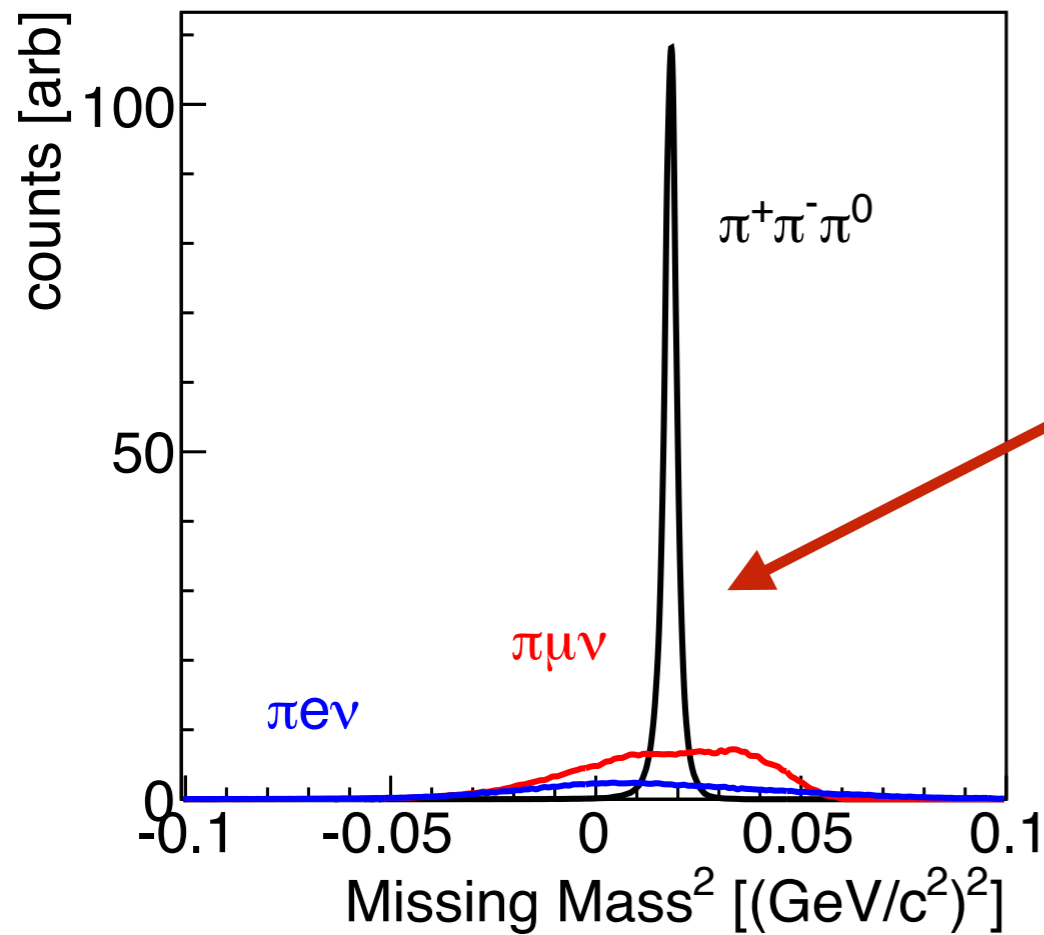
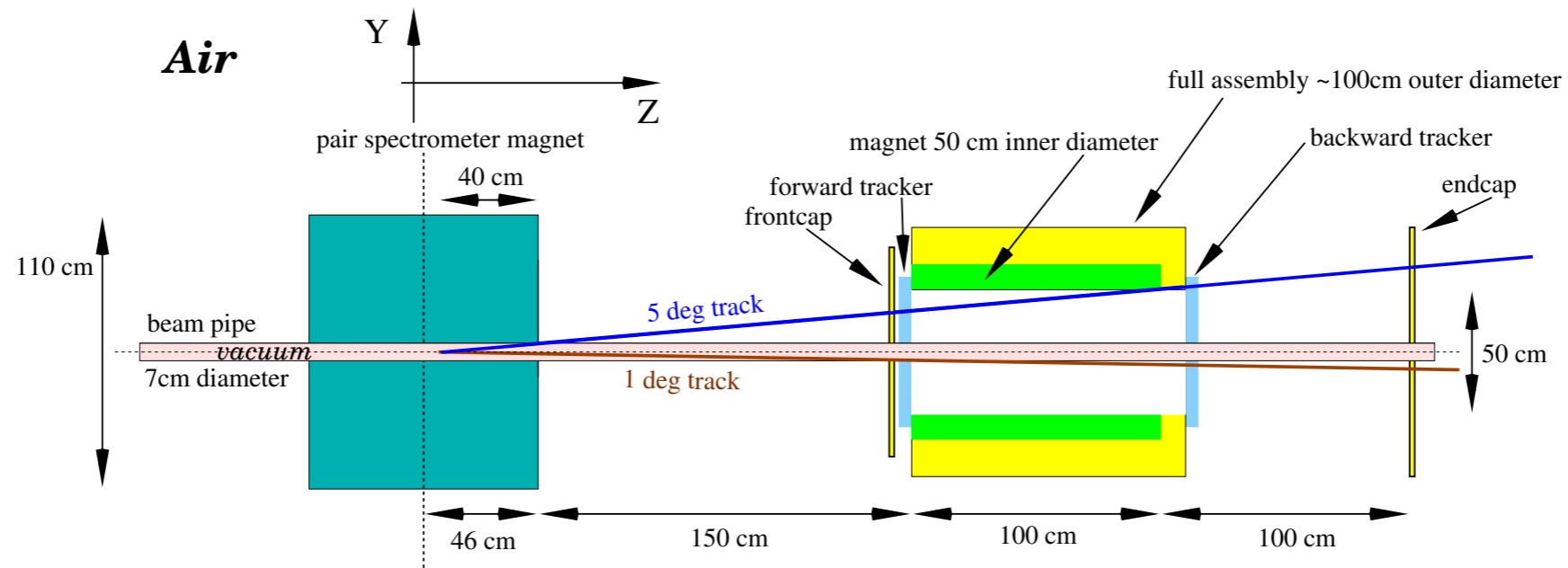

**Reconstructed  $K_L$**

**via missing ( $\pi^0$ )**

**Flux measurement stat. err. <1%**

**Estimated syst. err. ~5%**



# $K_L$ Beam Flux

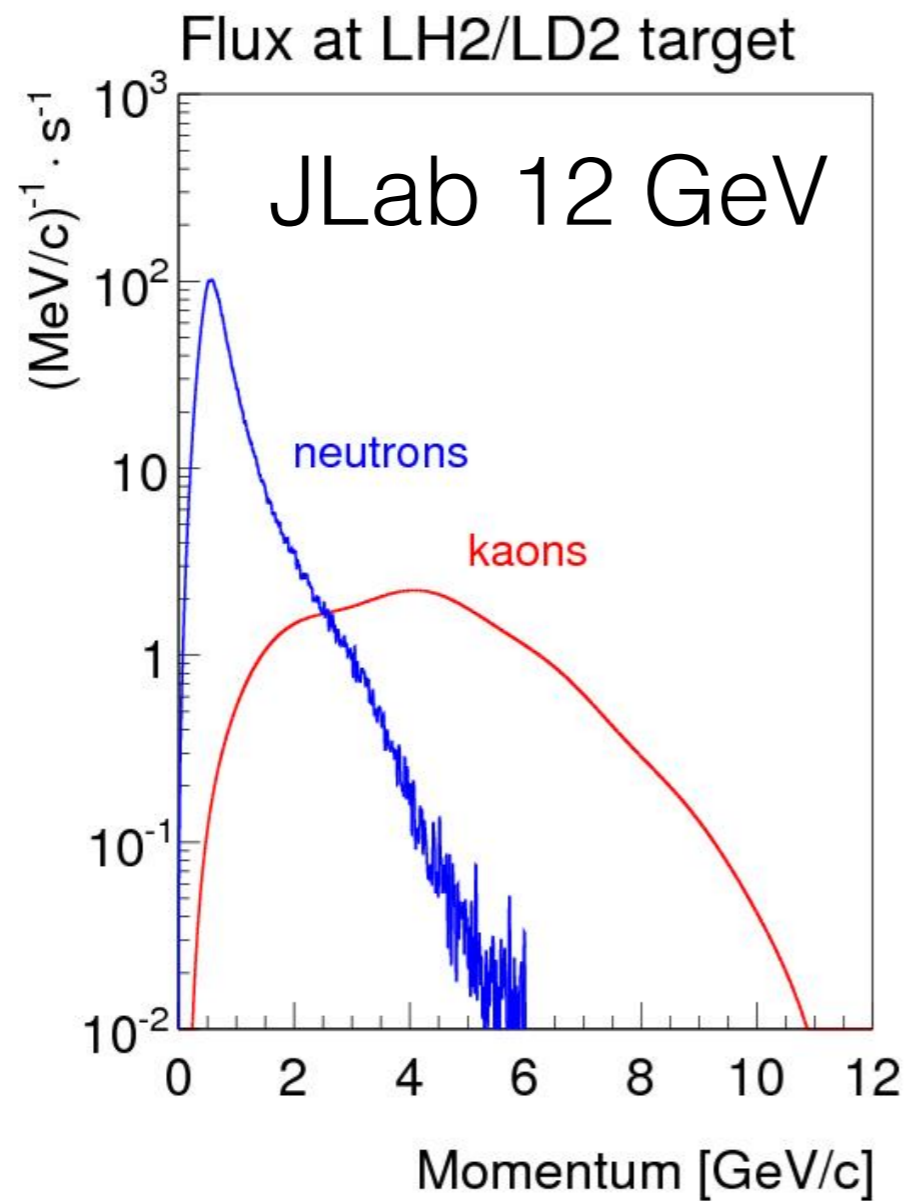

$$N(K_L)/sec \sim 10^4$$

# SLAC 16 GeV

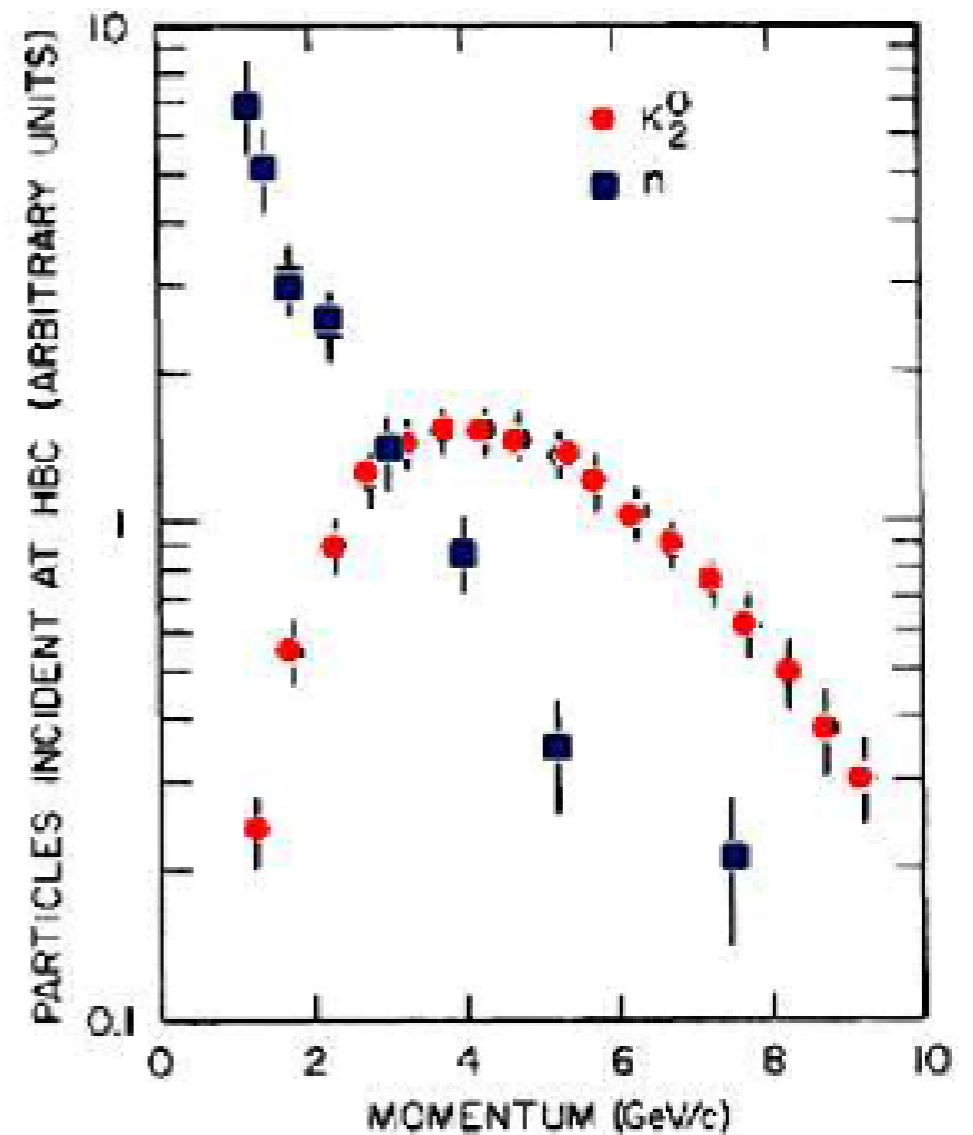

$$\frac{N(K_L)_{JLAB}}{N(K_L)_{SLAC}} \sim 10^3$$

# LH<sub>2</sub>/LD<sub>2</sub> Cryogenic Target for Neutral Kaon Beam at Hall D

The GlueX liquid hydrogen target.

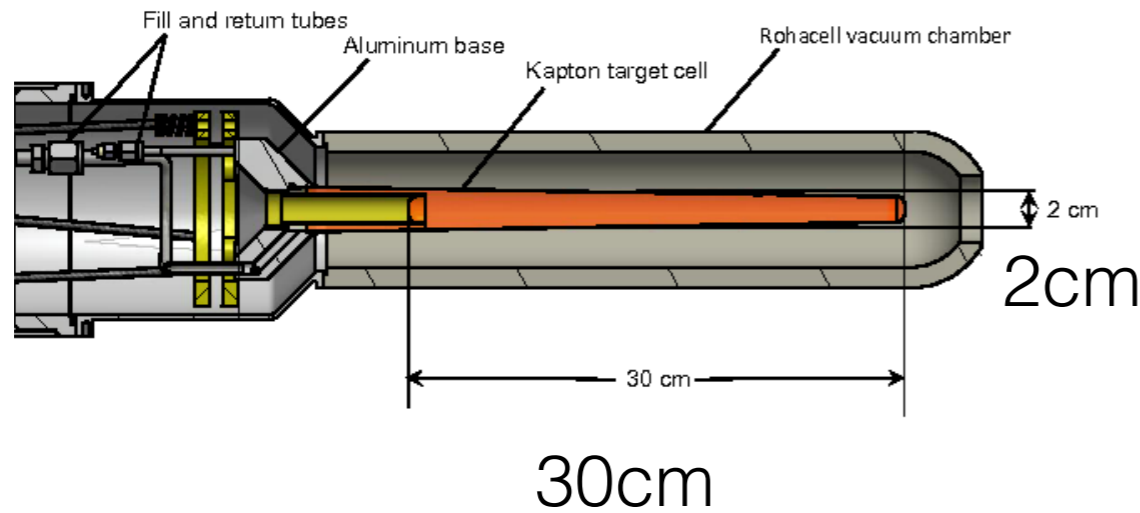

*Current*

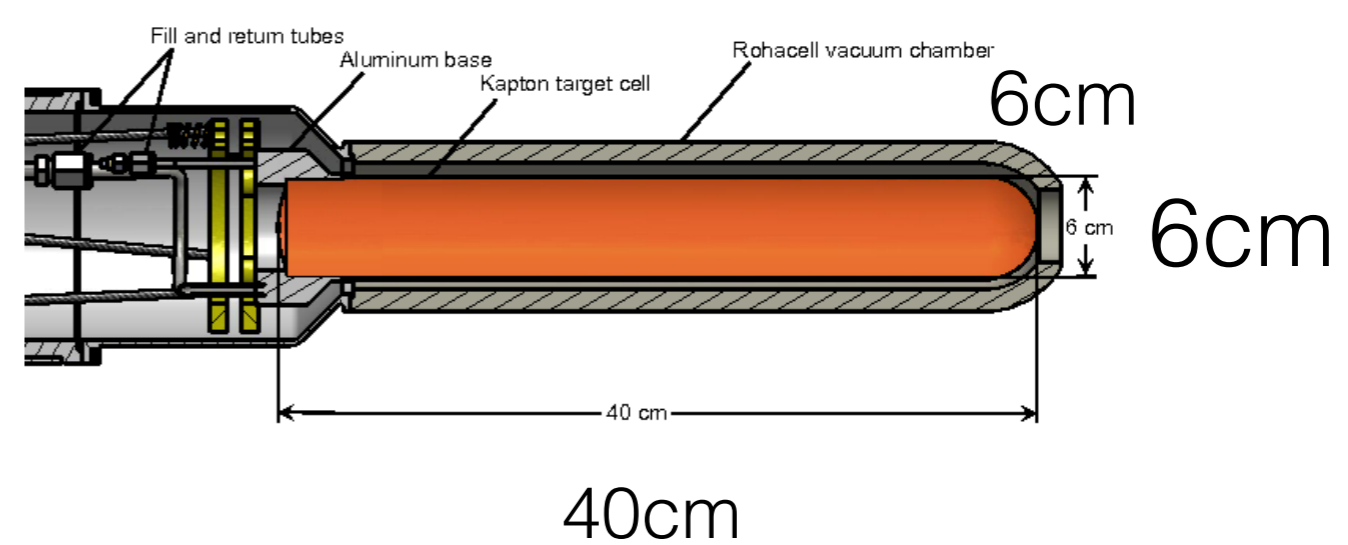

*Proposed & Feasible*

**Longer and thicker target is needed to enhance production rate**

**Conceptual design has been endorsed by the JLAB target group**

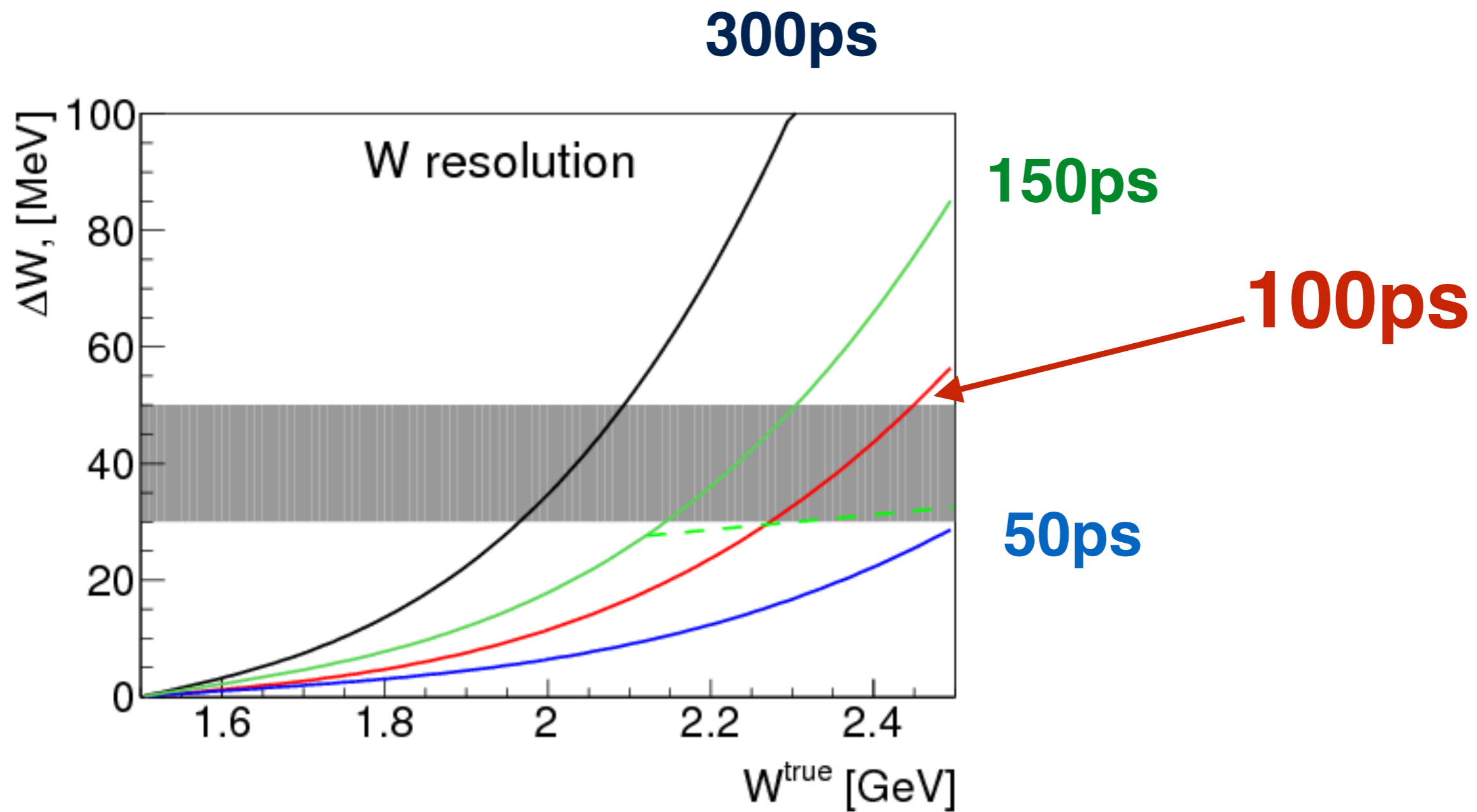

# Strange Meson Spectroscopy



## $K\pi$ Scattering

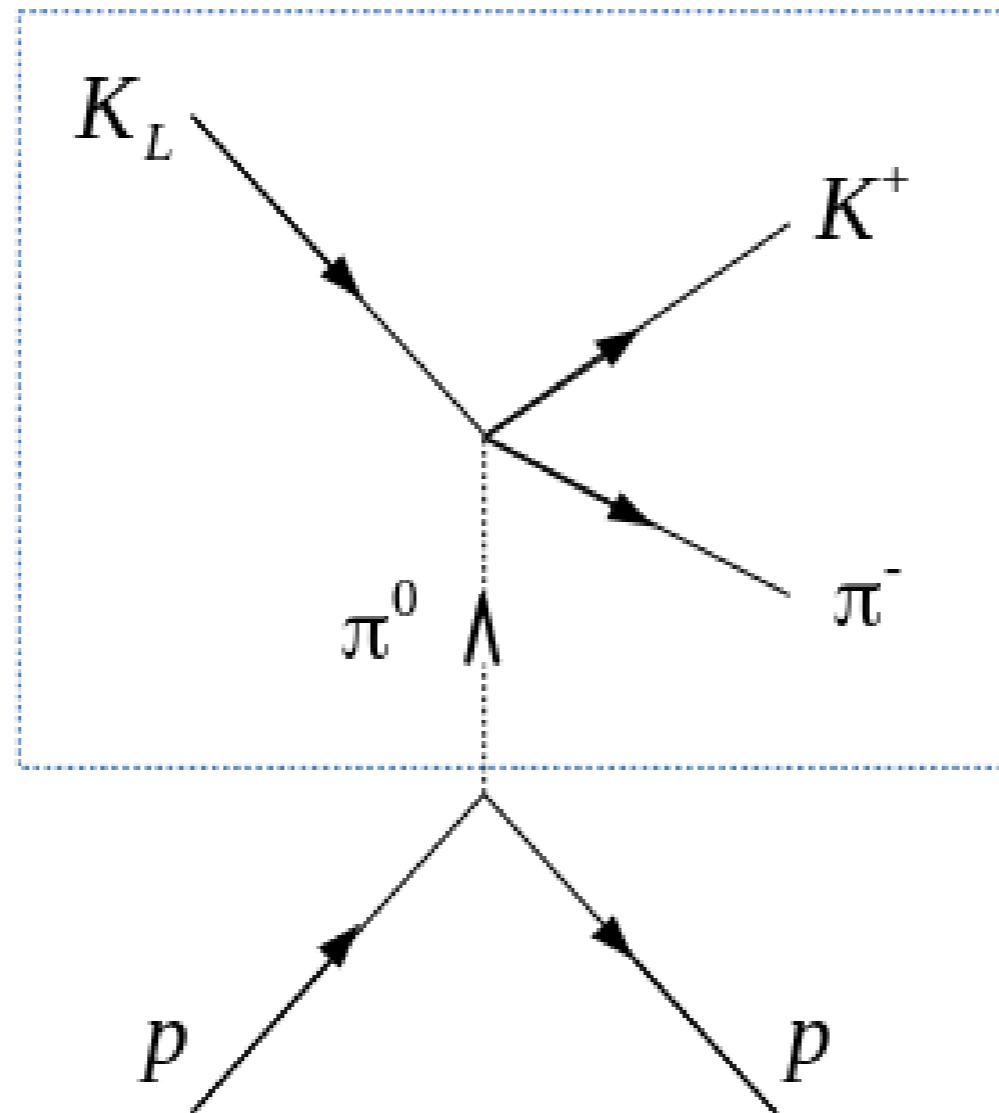

# Scalar Meson Nonet

$$J^{PC} = 0^{++}$$

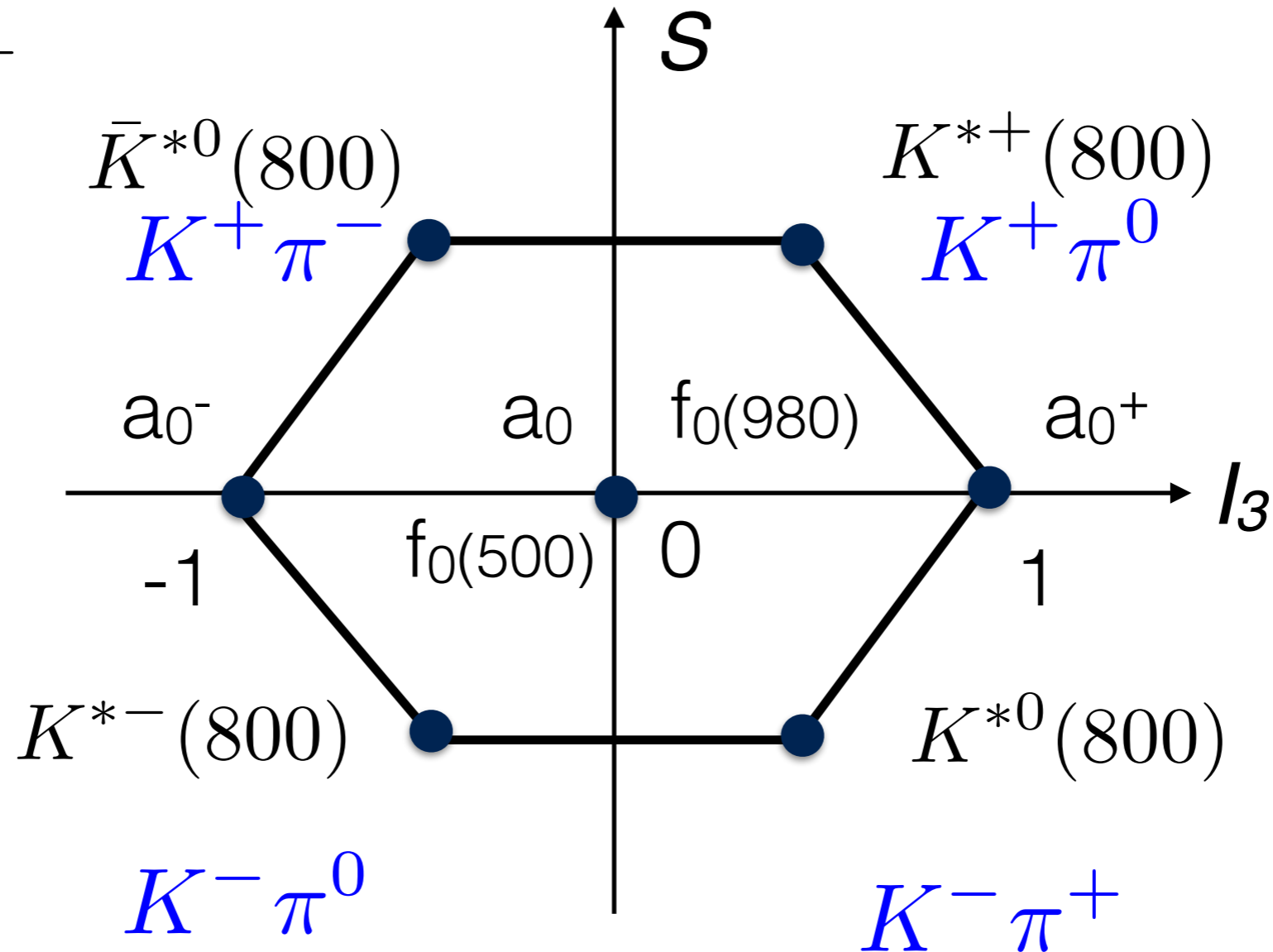

**Four states called  $\kappa$**

**still need further confirmation(PDG)**

**We can measure all of them**

# Proposed Measurements

SLAC

$$K^- \pi^+ \rightarrow K^- \pi^+$$

Belle

$$\tau \rightarrow K \pi \nu_\tau$$

KLF

$$K_L \pi^0 \rightarrow K^+ \pi^-$$

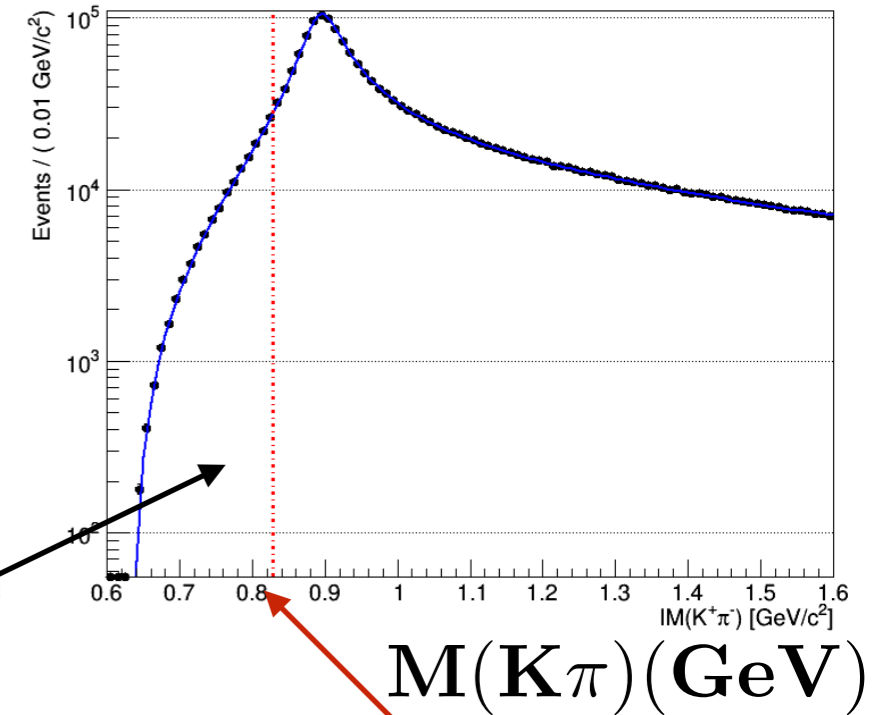
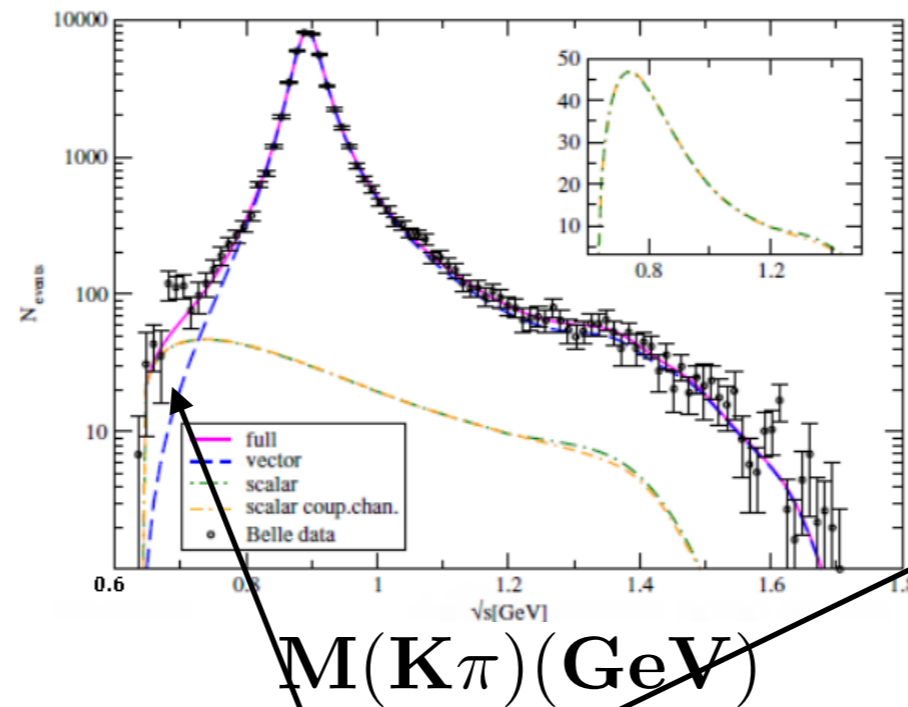
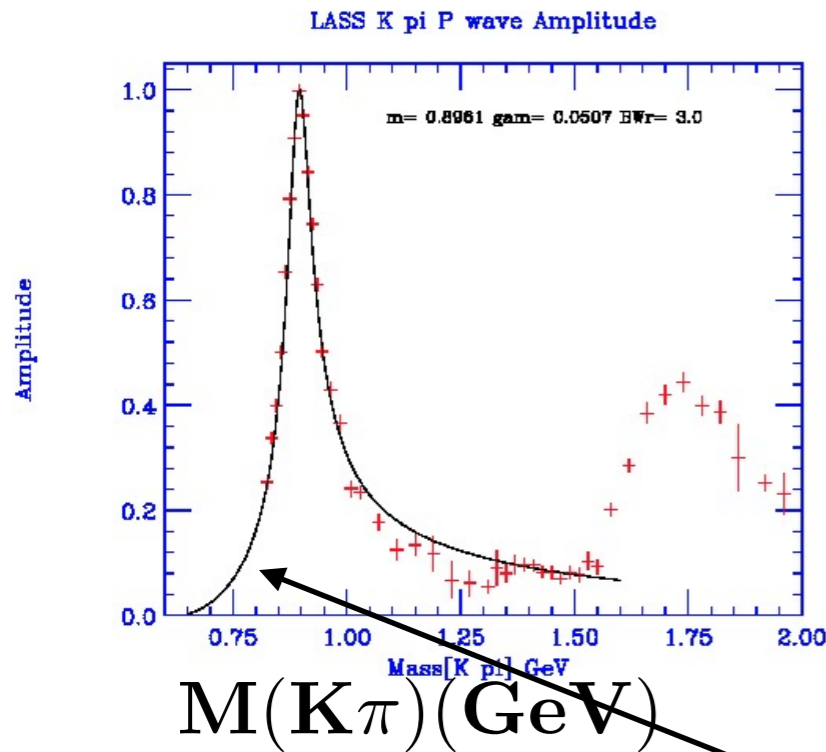

region of  $\mathcal{K}(800)$

SLAC Lower limit

Transfer Four Momentum Efficiency

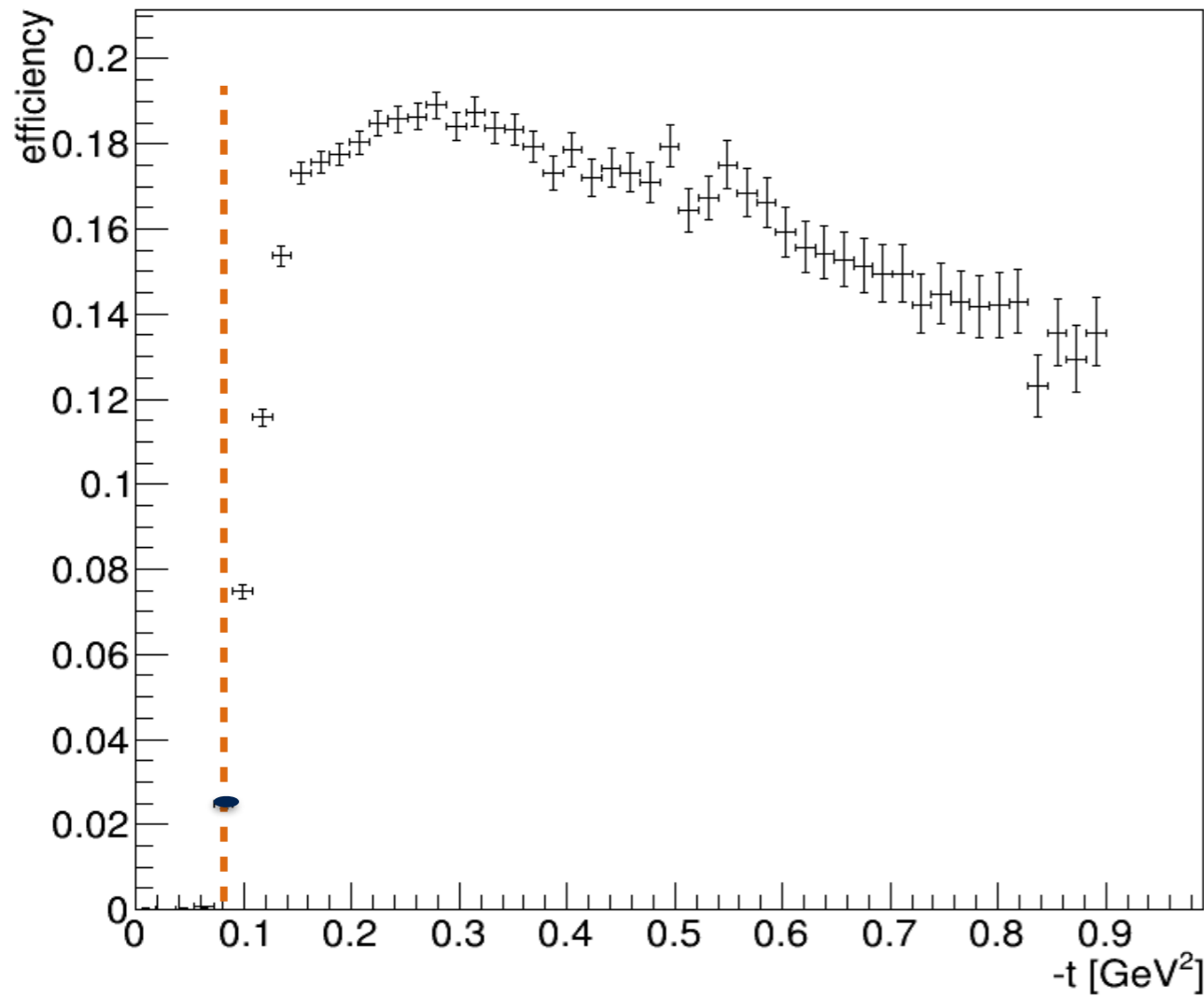

Transfer Four Momentum Efficiency

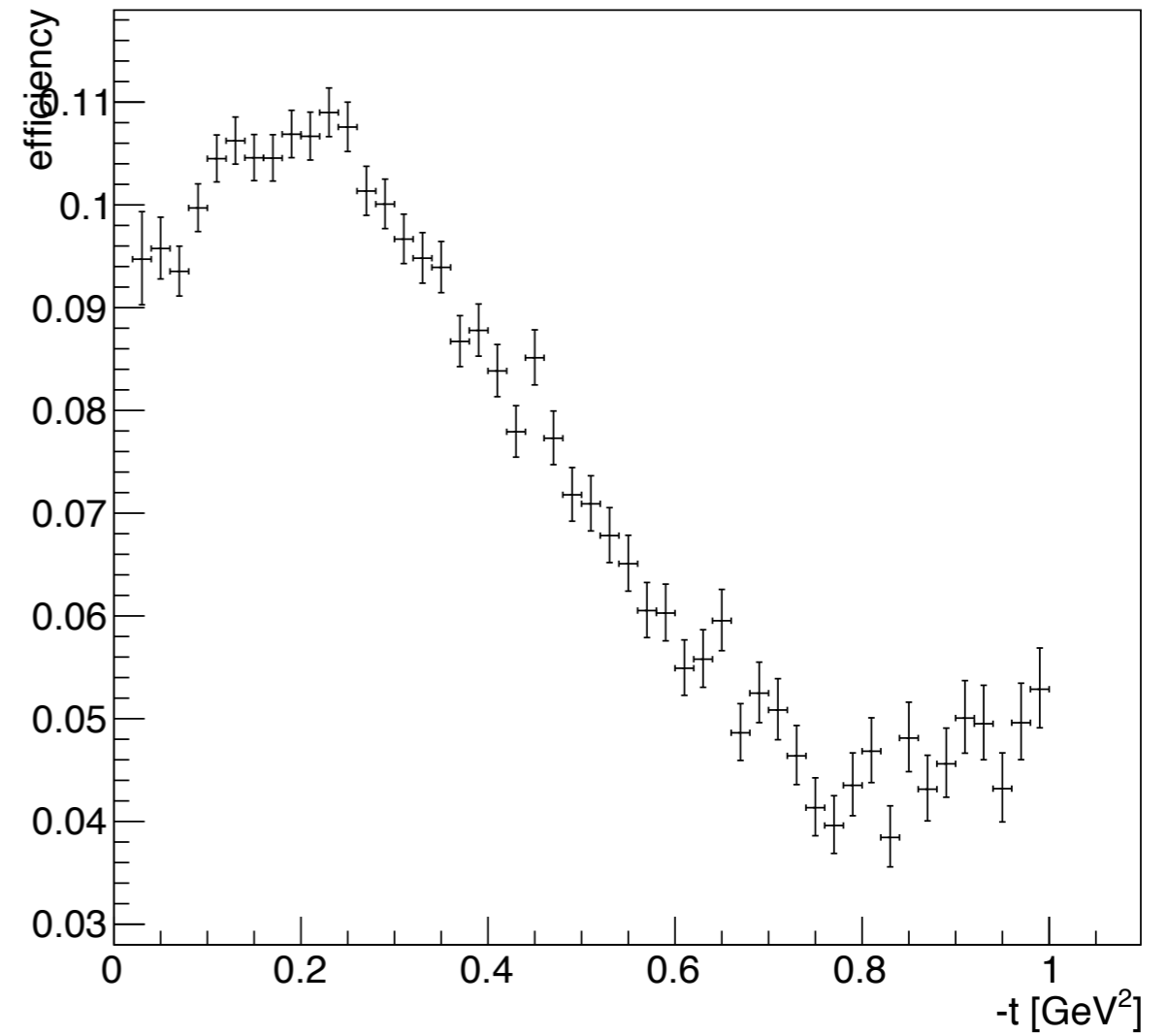

**t-down to 0.08 GeV<sup>2</sup> is measurable  
with proton being detected**

**t-down to pion pole  
proton missing**

# $K\pi$ Scattering

## (proton detected)

Four Momentum Resolution for  $K_L p \rightarrow K^+ \pi^- p$

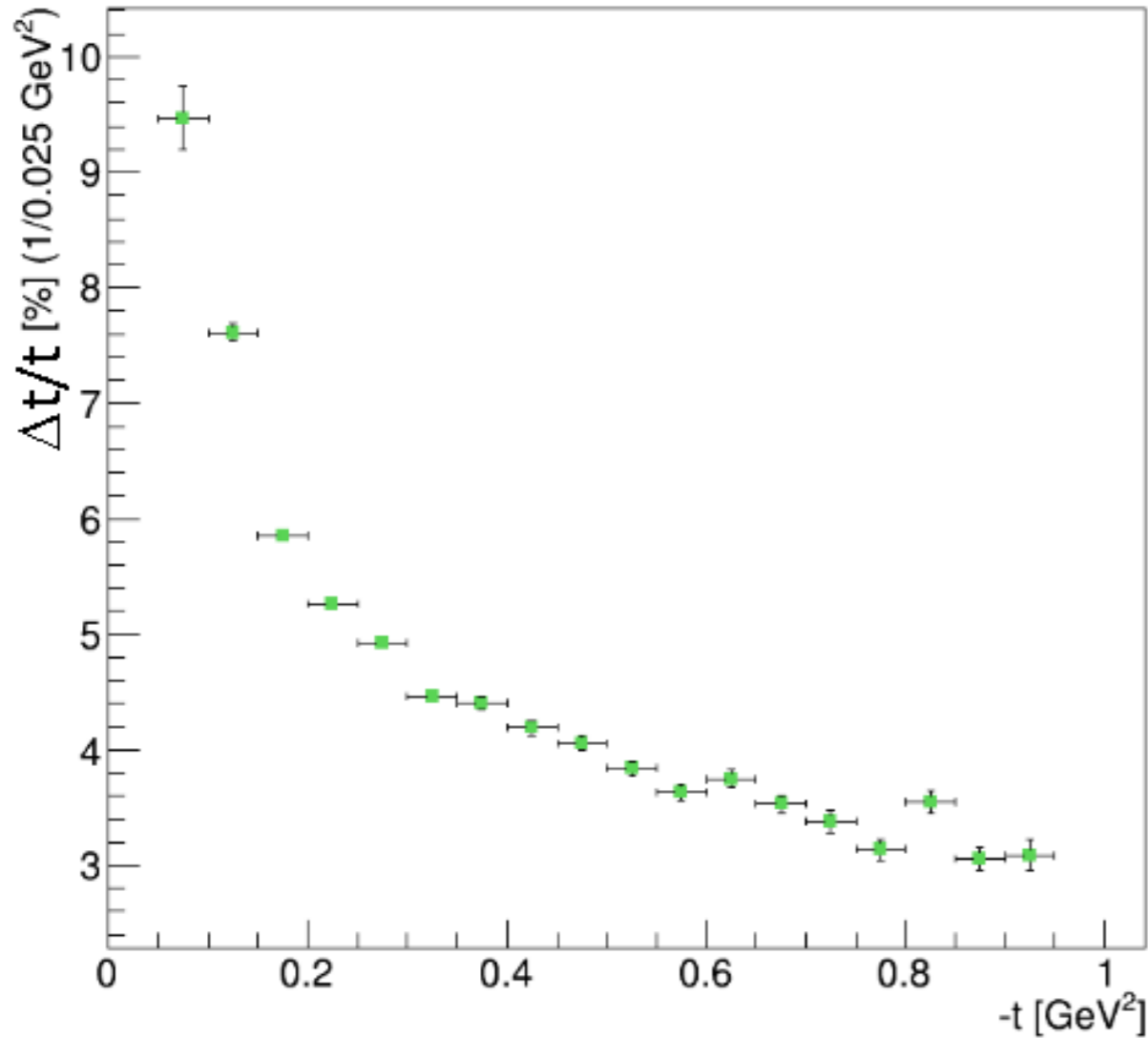

$K^+ \pi^-$  Invariant Mass Resolution for  $K_L p \rightarrow K^+ \pi^- p$

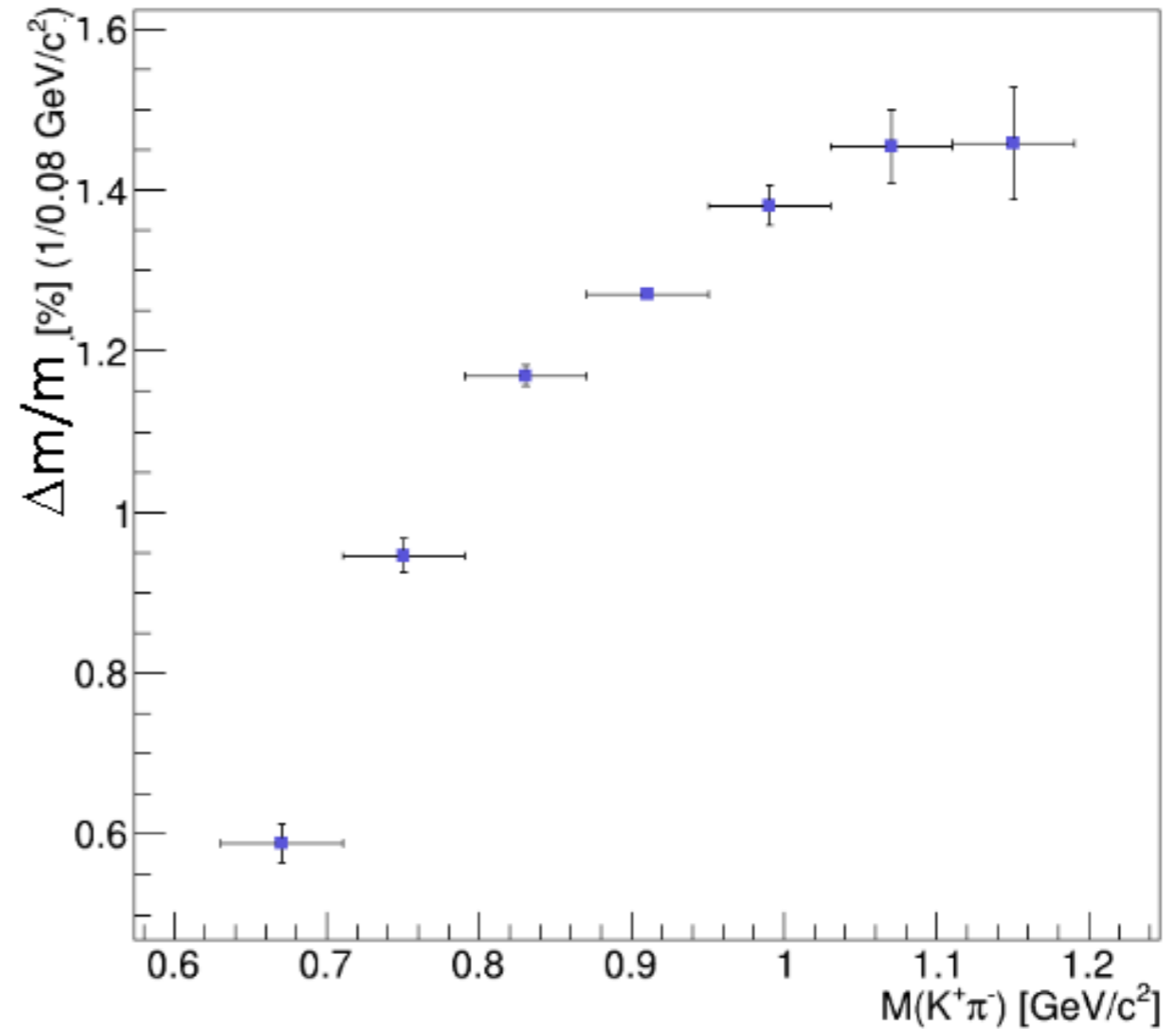

*-Good resolution at low- $t$  is needed to be close to pion pole*

*-Binning in  $\sim 10 \text{ MeV}$  will cover almost entire elastic  $K$ - $\pi$  scattering range*



# $K\pi$ Scattering

## (proton missing)

Four Momentum Resolution for  $K_L p \rightarrow K^+ \pi^- (p)$

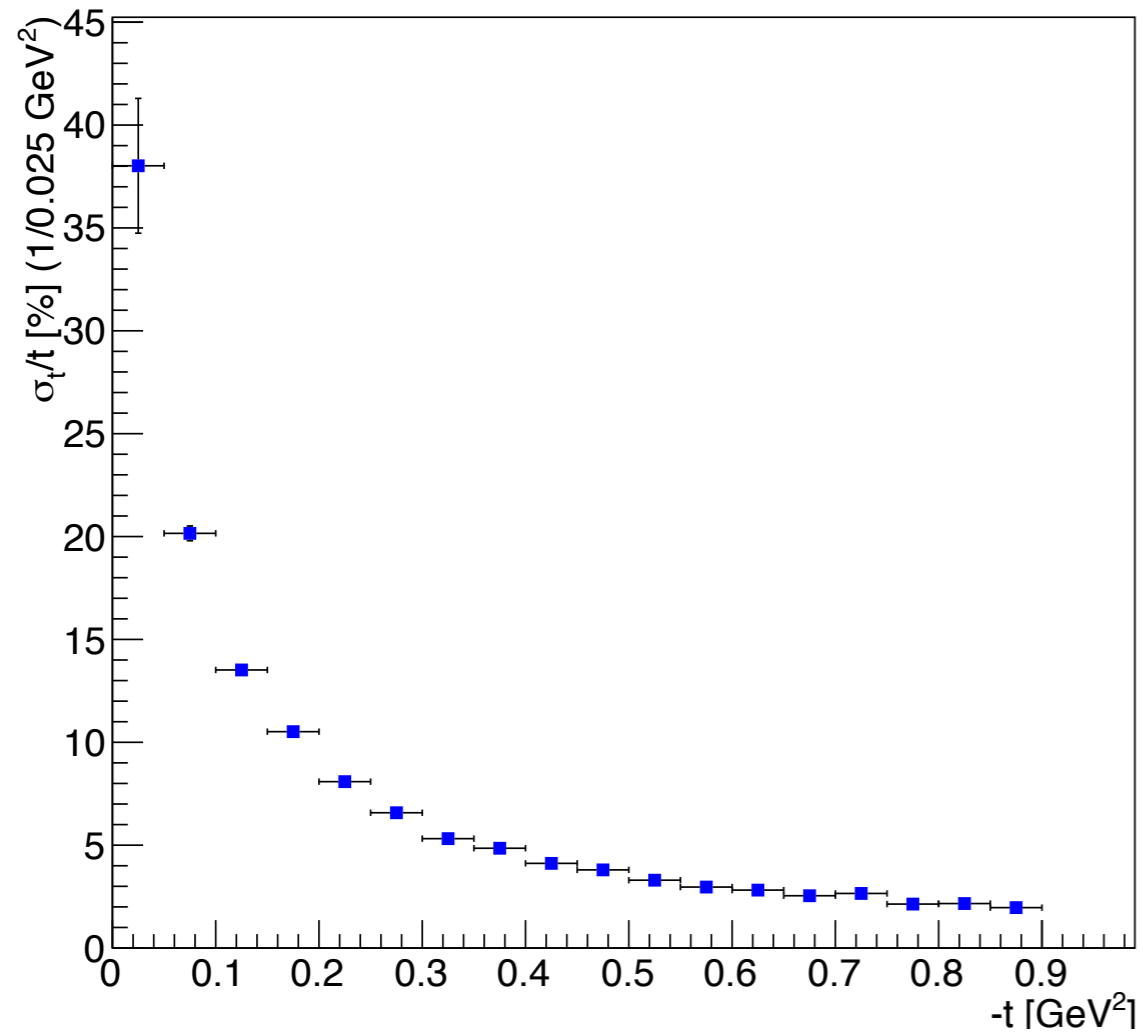

$K^+ \pi^-$  Invariant Mass Resolution for  $K_L p \rightarrow K^+ \pi^- (p)$

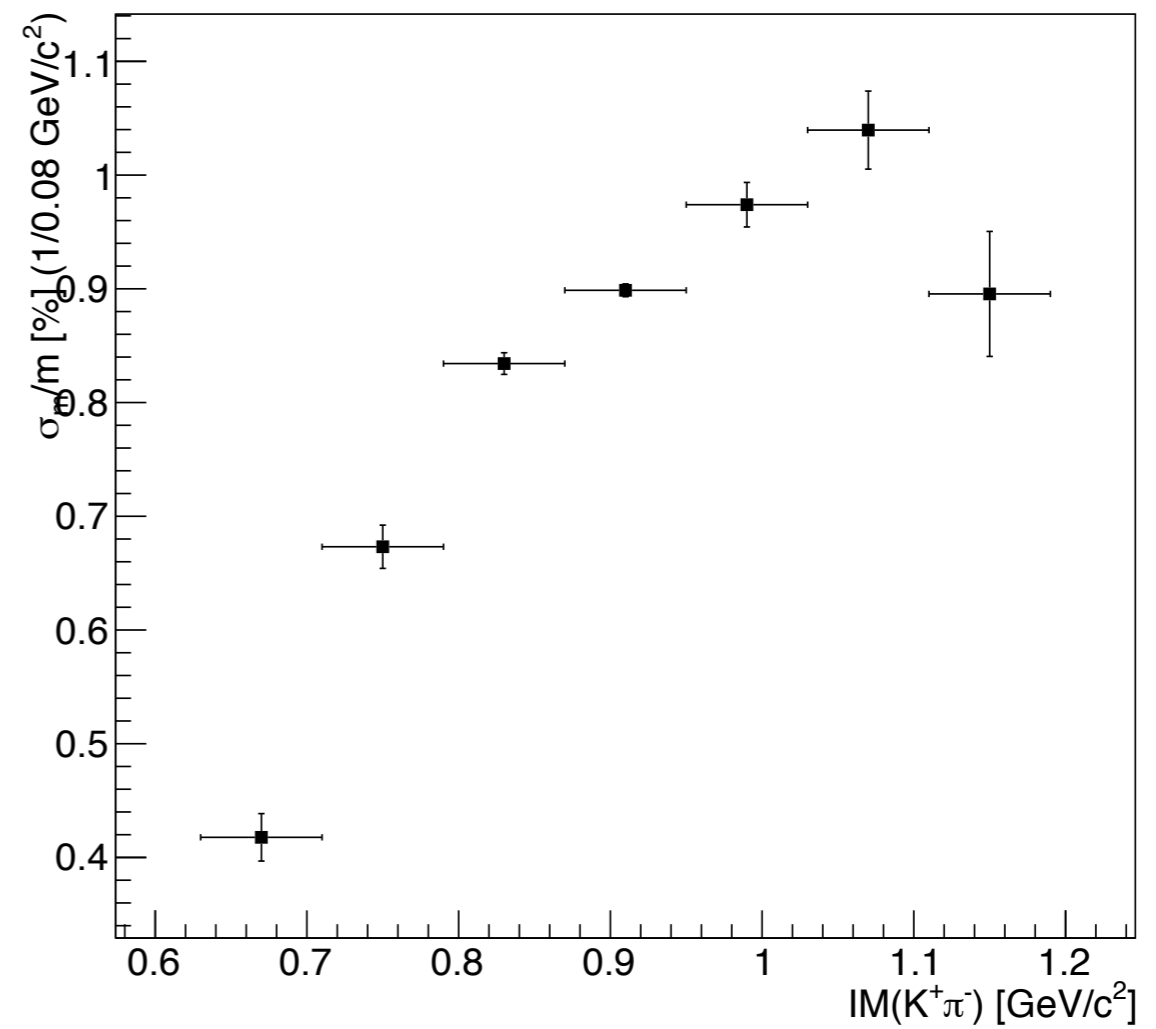

# Missing Mass of $K^+\pi^-$ system

## MM( $K^+\pi^-$ ) vs $p(K_L)$

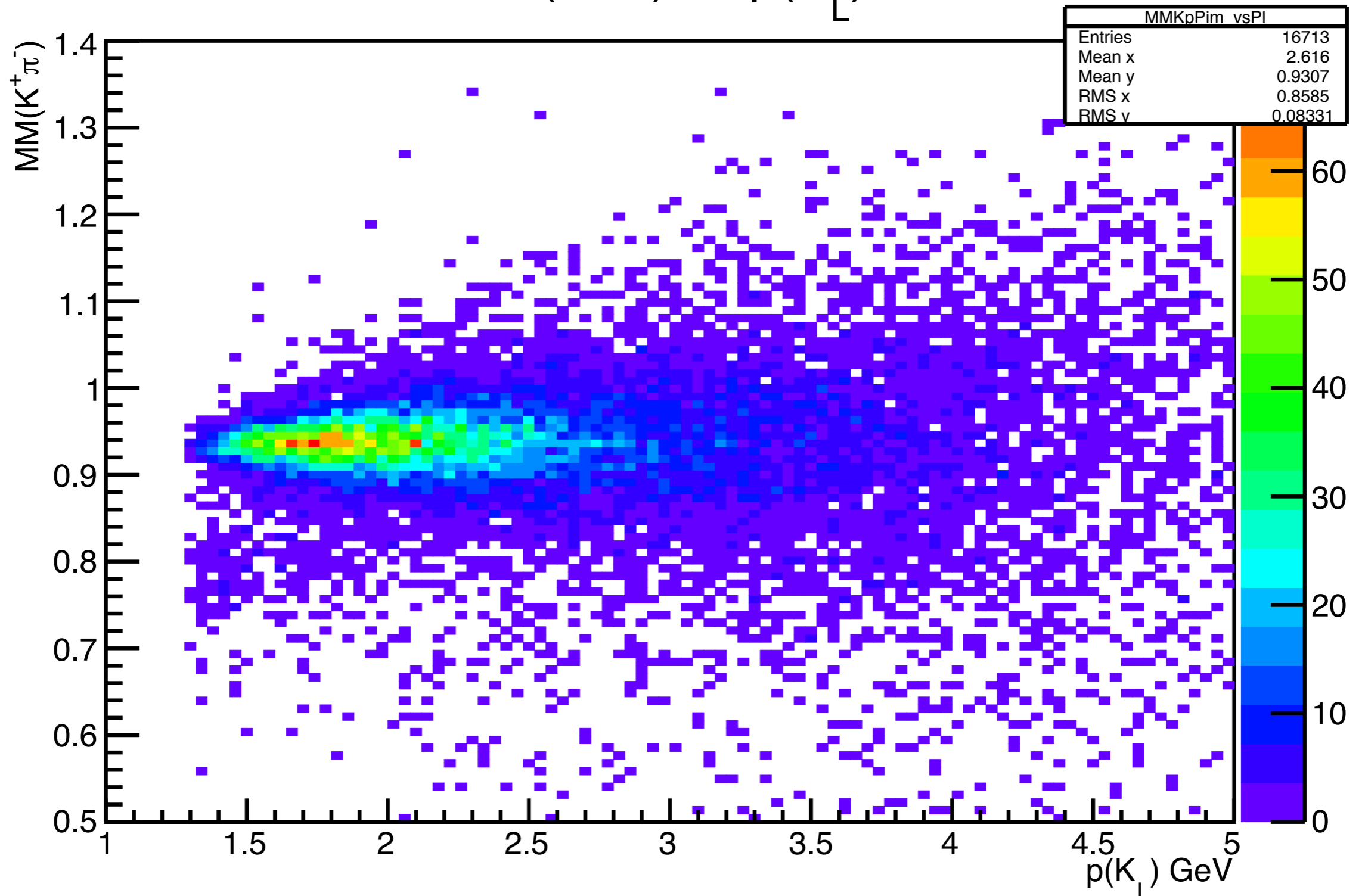

# Missing Mass $MM(K^+\pi^-)GeV$

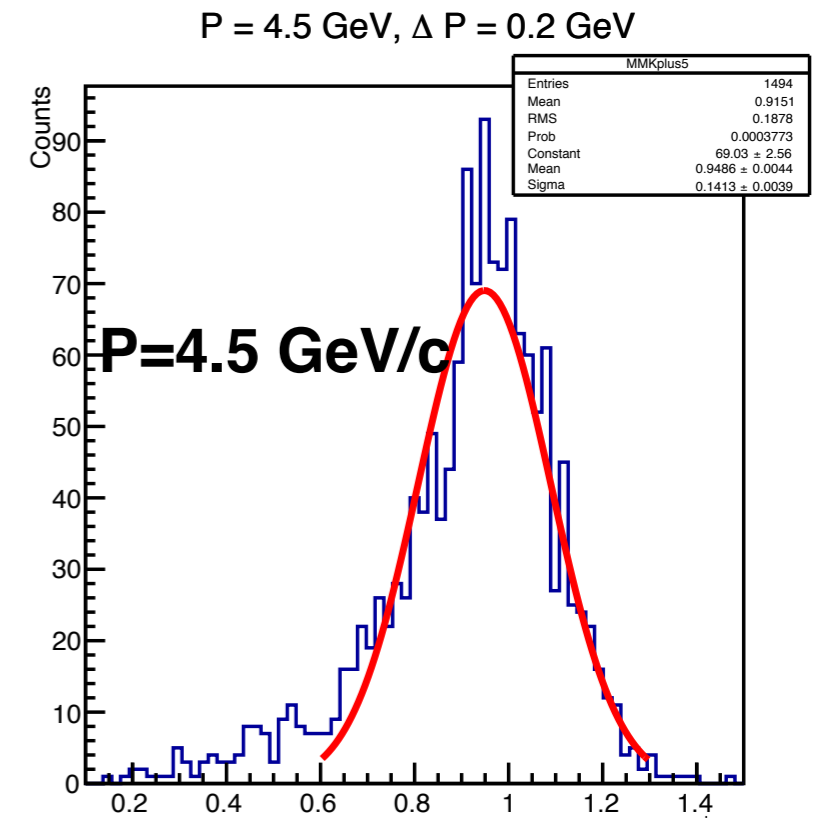
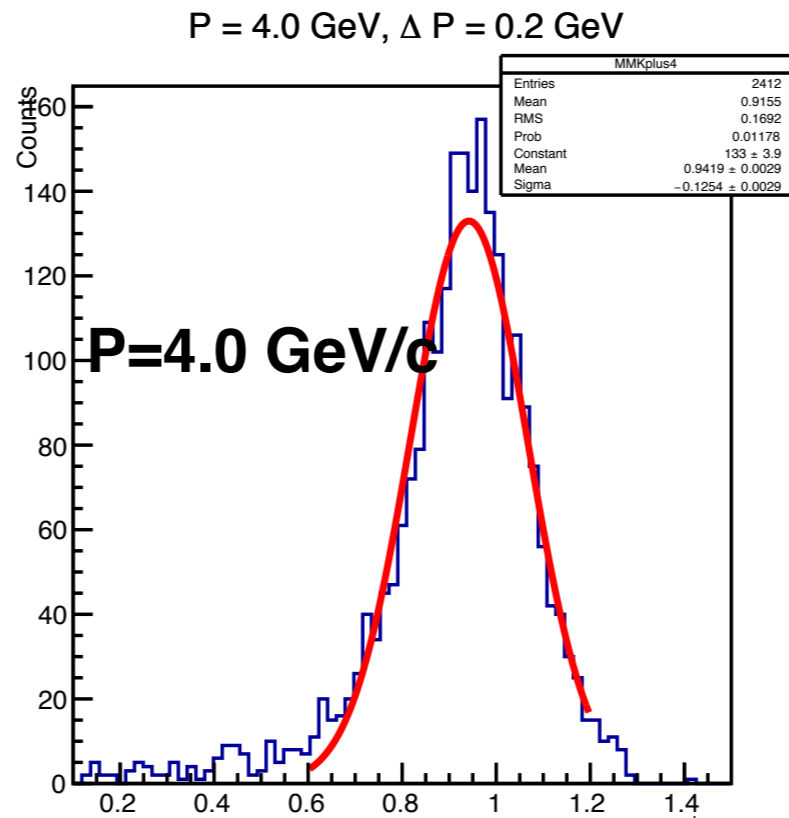
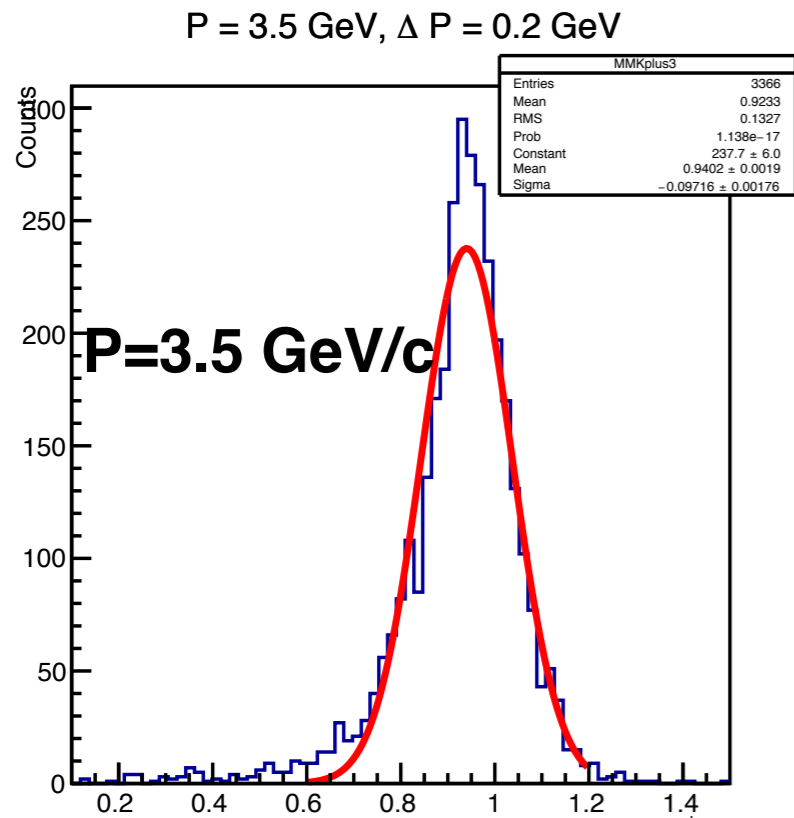
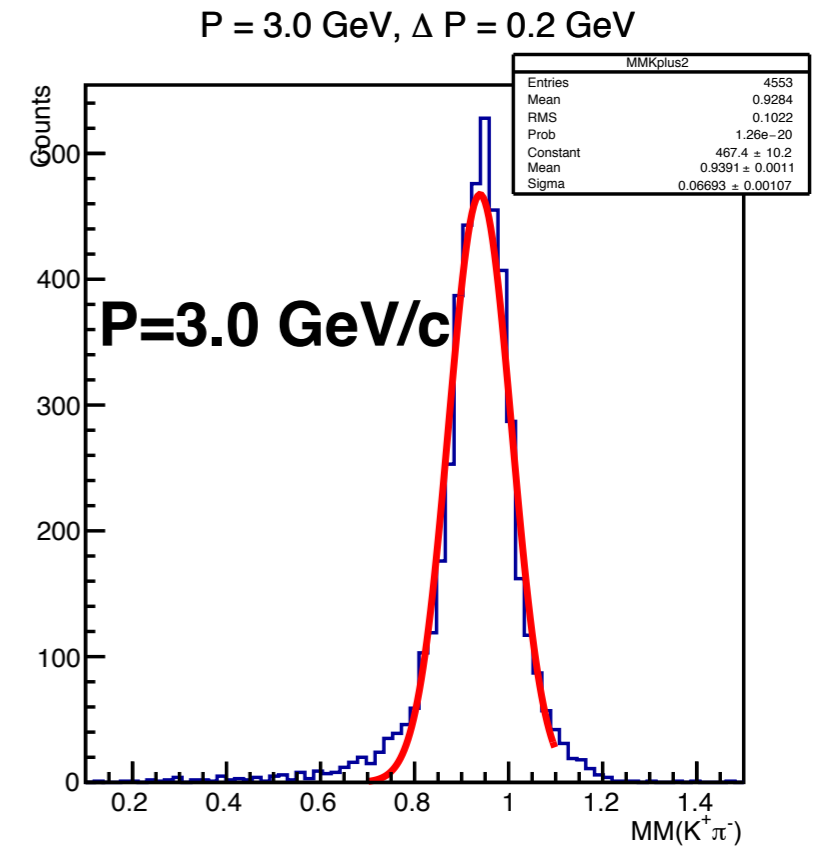
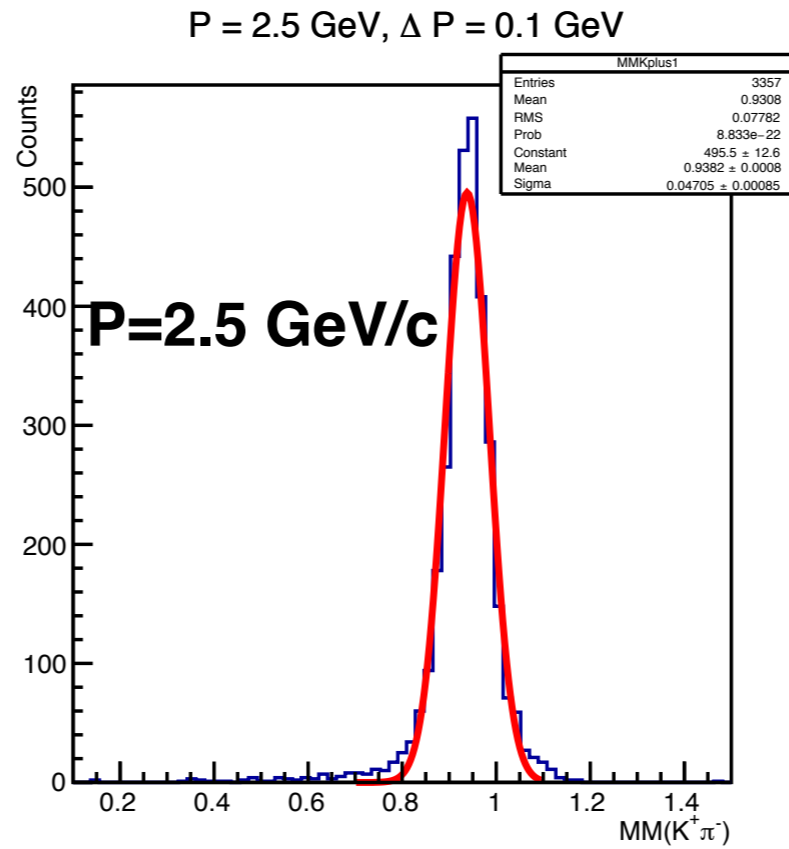
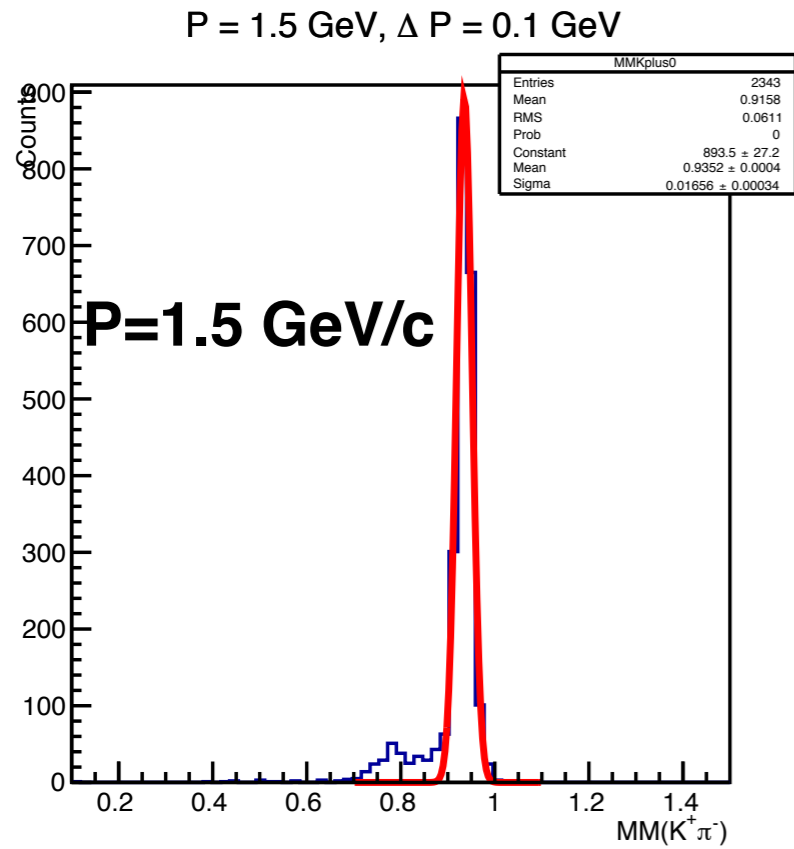

# Proton reconstructed via missing mass

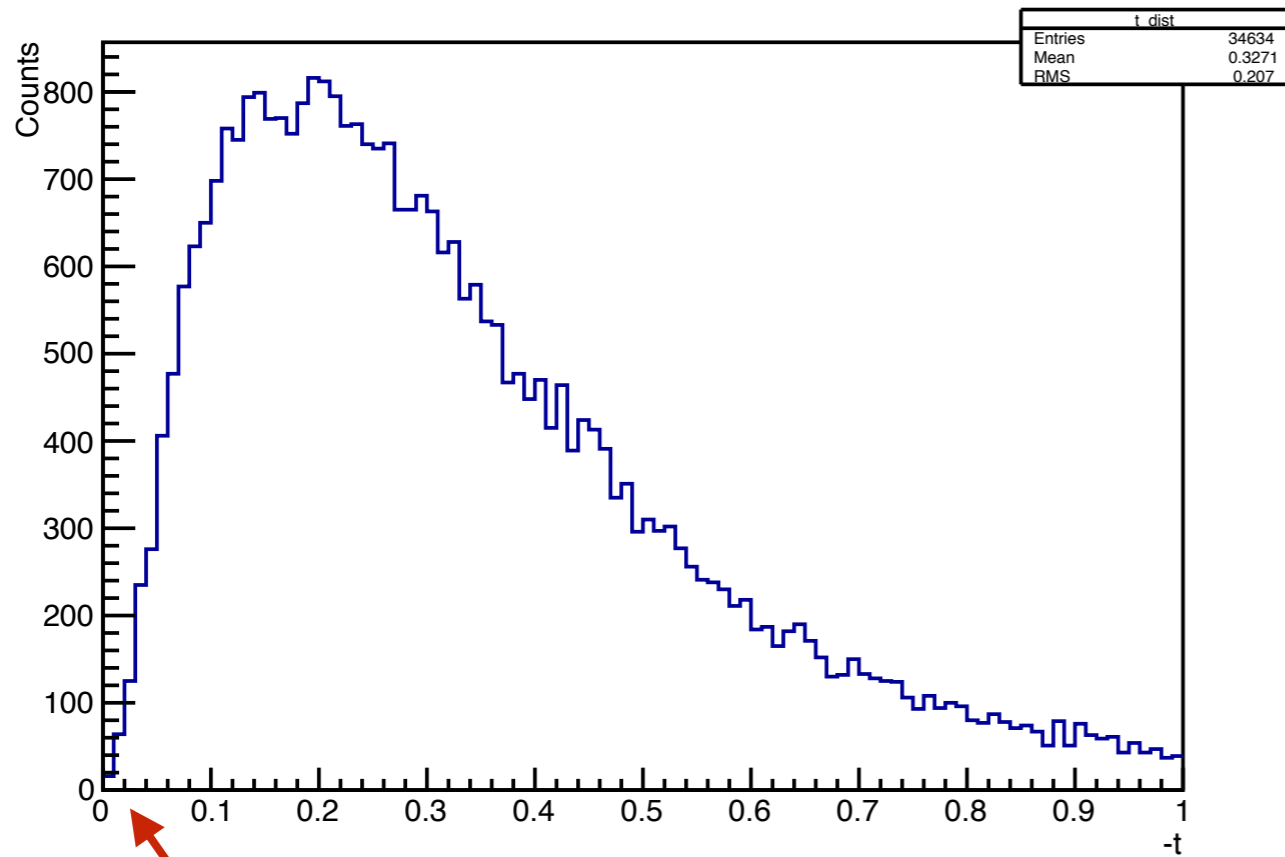

$-t, (\text{GeV}/c)^2$

**Down to pion pole**

$K_L$  beam profile

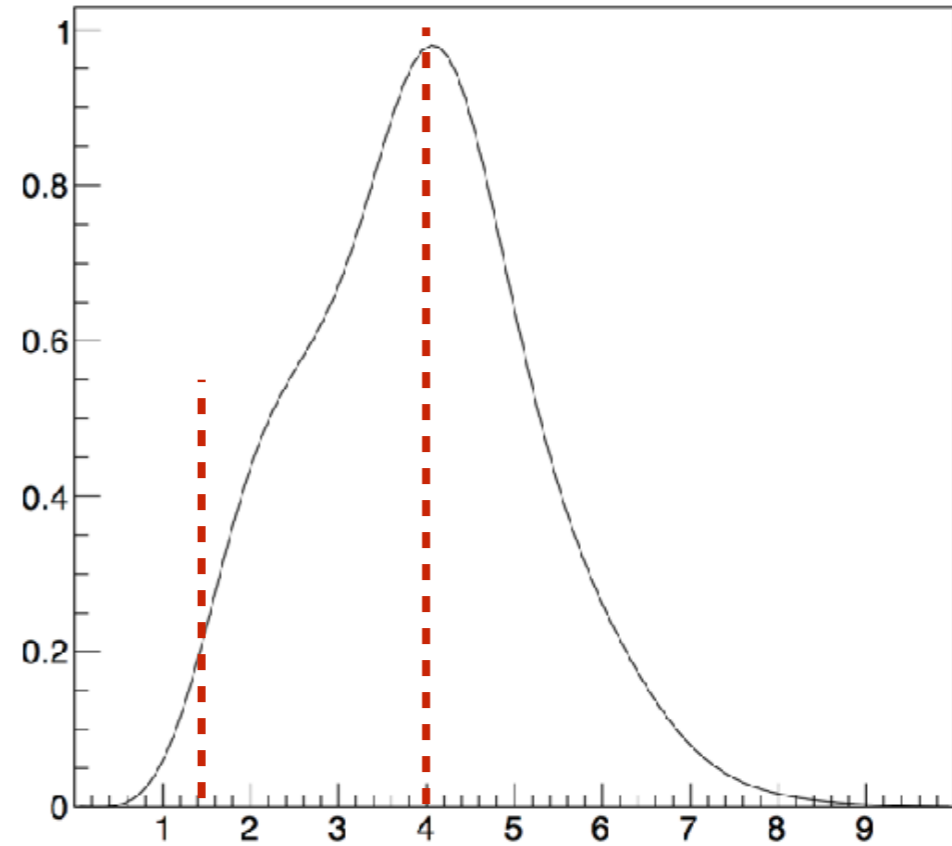

$P(K_L), \text{GeV}/c$

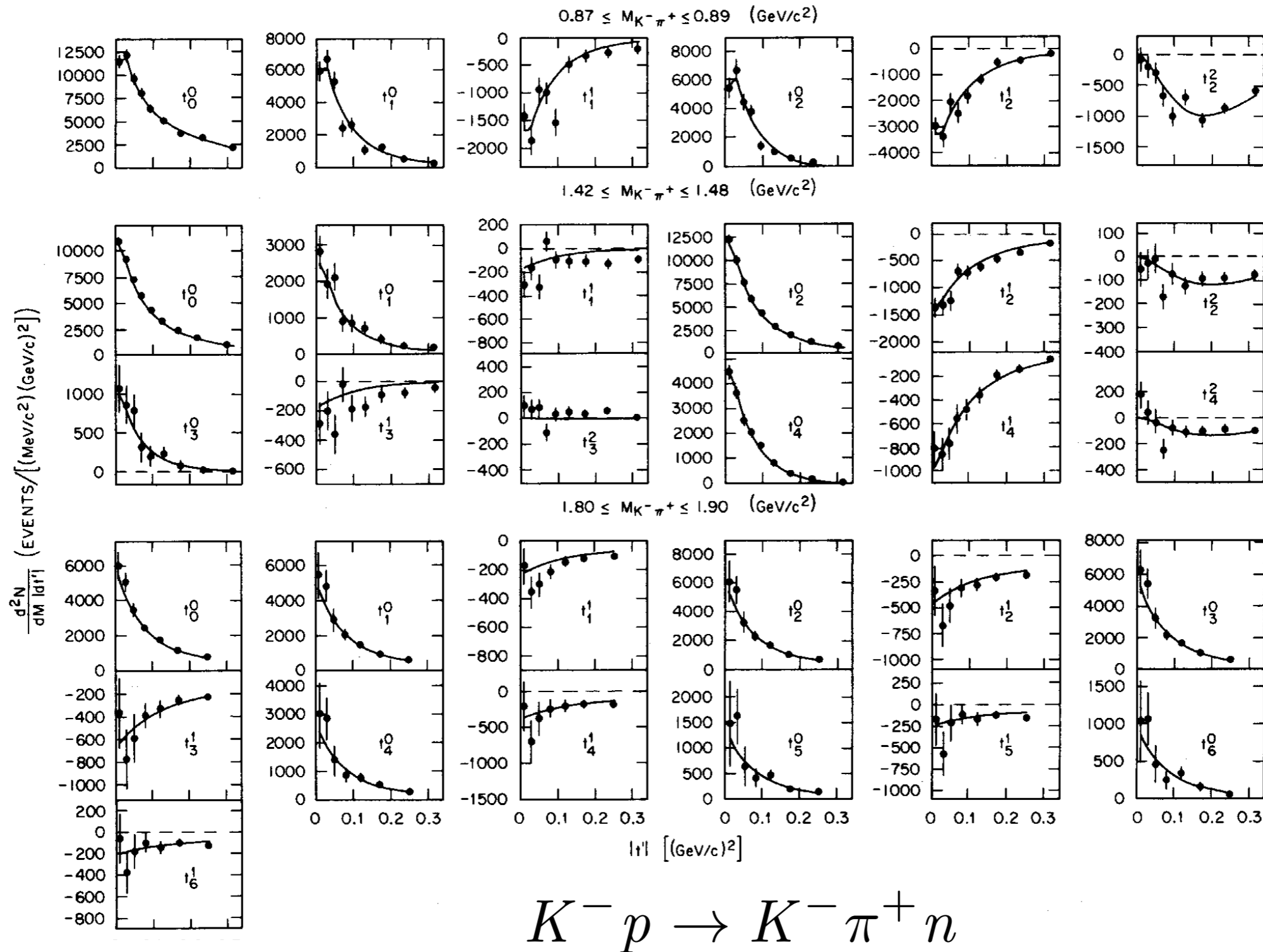
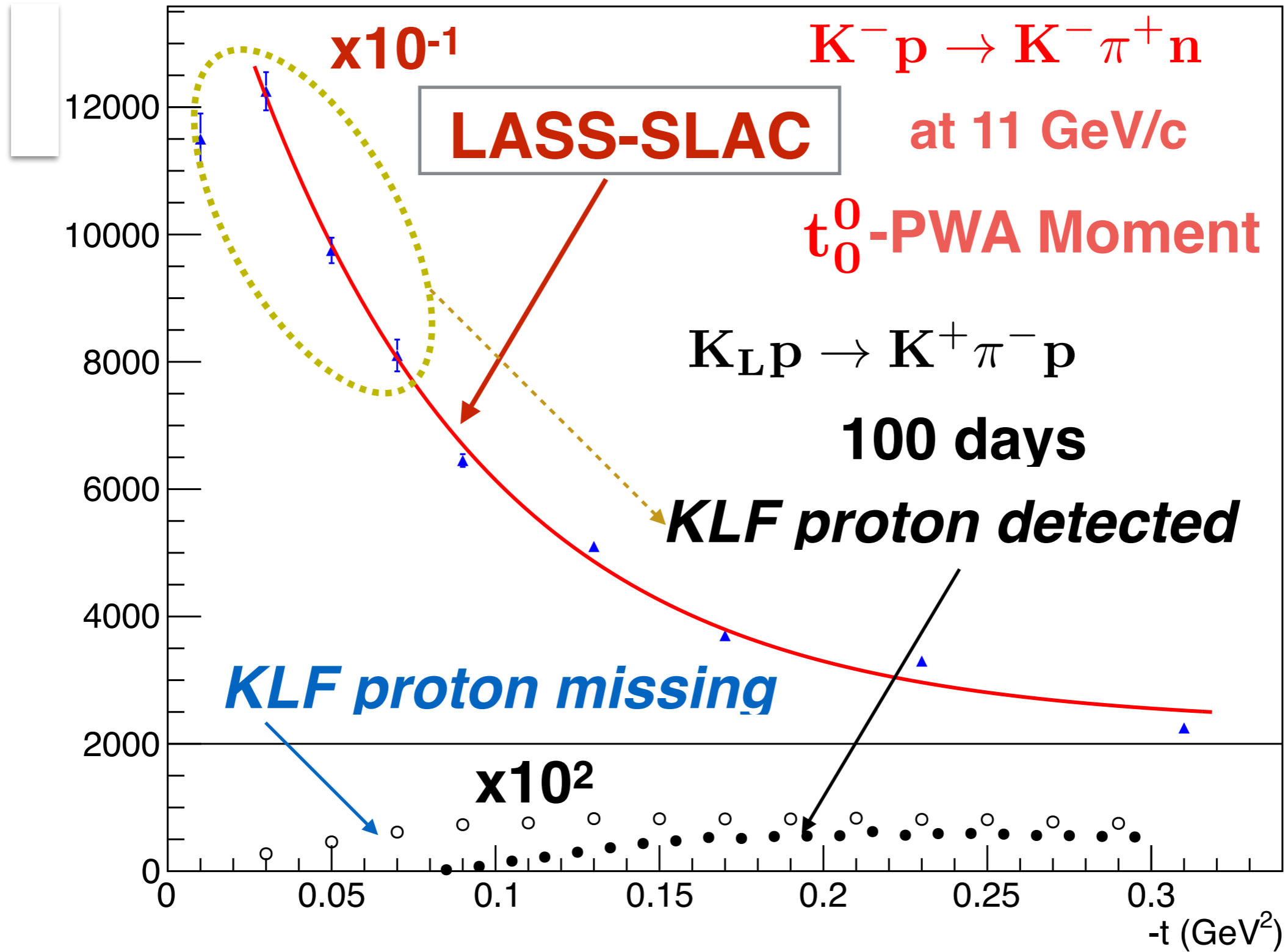

Fig. 9. The acceptance corrected unnormalized  $K^- \pi^+$  moments as a function of  $|t'|$ . Three different mass regions are shown;  $0.87 \leq M_{K\pi} \leq 0.89 \text{ GeV}/c^2$ ,  $1.42 \leq M_{K\pi} \leq 1.48 \text{ GeV}/c^2$ , and  $1.80 \leq M_{K\pi} \leq 1.90 \text{ GeV}/c^2$ . The curves are the result of a fit to the production model described in the text.

$$M_{K-\pi^+} = 0.87 - 0.89 \text{ GeV}$$



**Two orders of magnitude higher statistics with KLF plus down to the threshold of  $M(K-\pi)$ !**

# Projected Measurements

$I=3/2+1/2$

$S$ -wave

SLAC Data

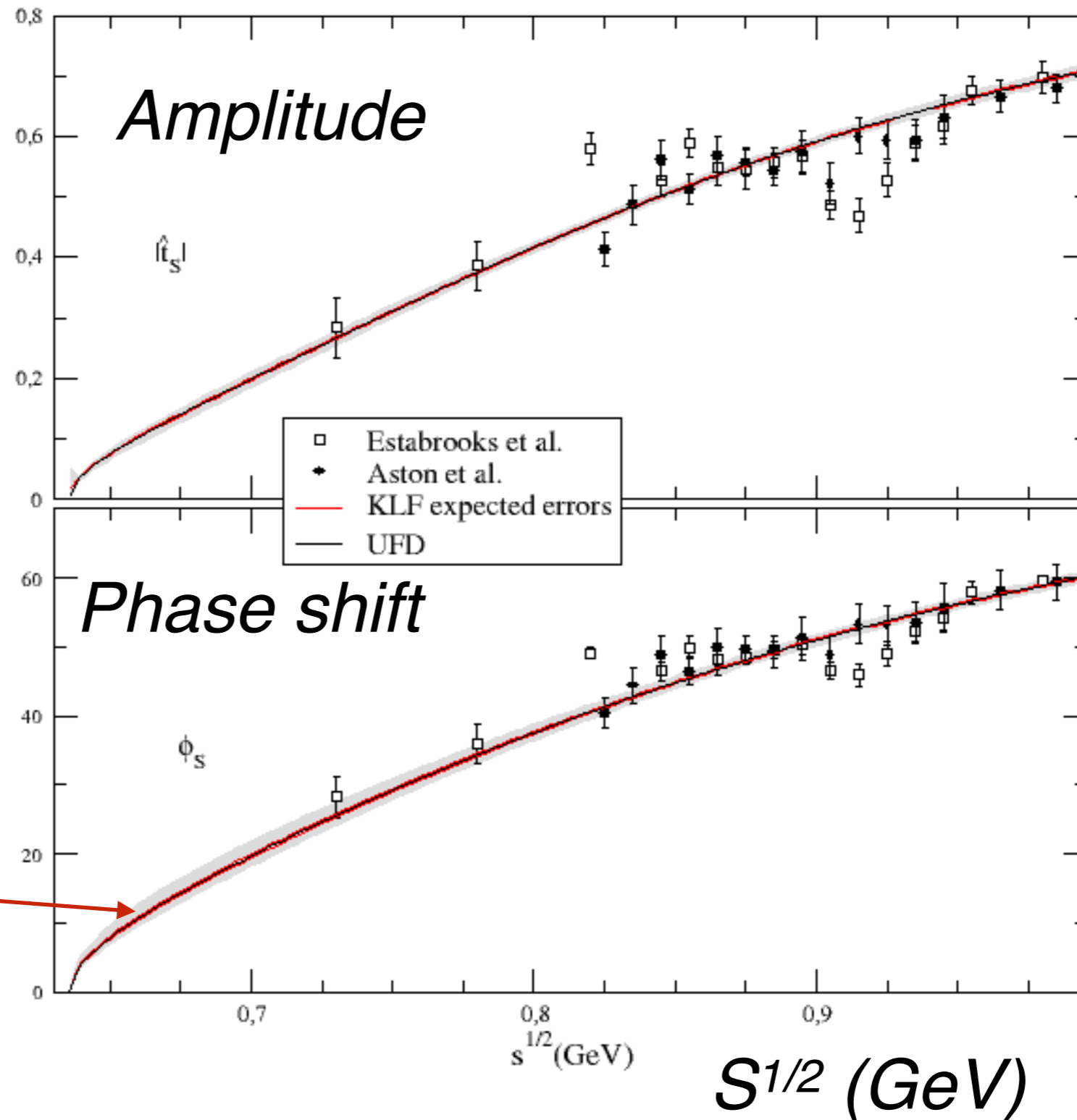

# Width and Mass of $\kappa$ (800)

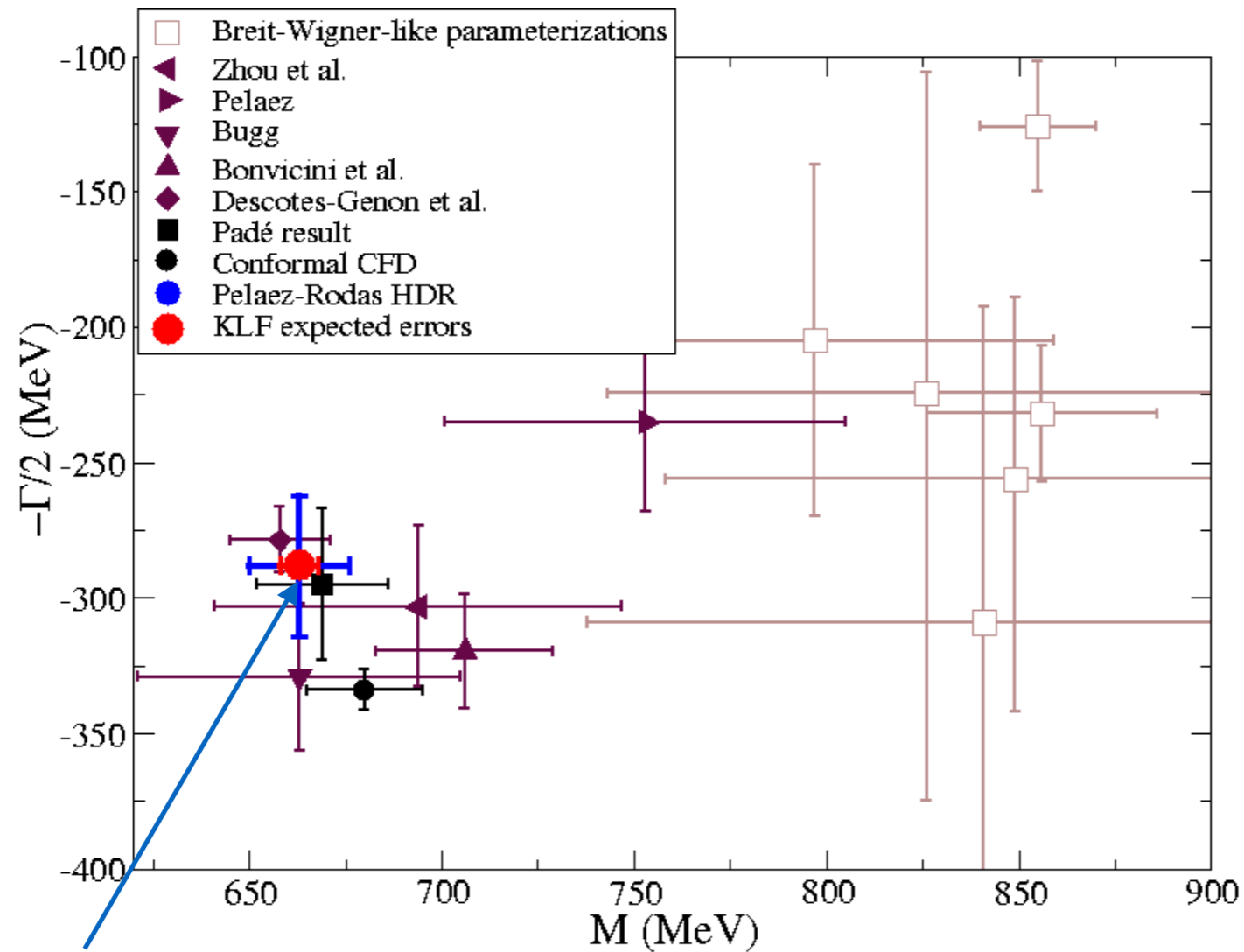

*100 days of running*

**Measurement with KLF will reduce:  
Uncertainty in the mass by factor of two  
Uncertainty in the width by factor of five!**



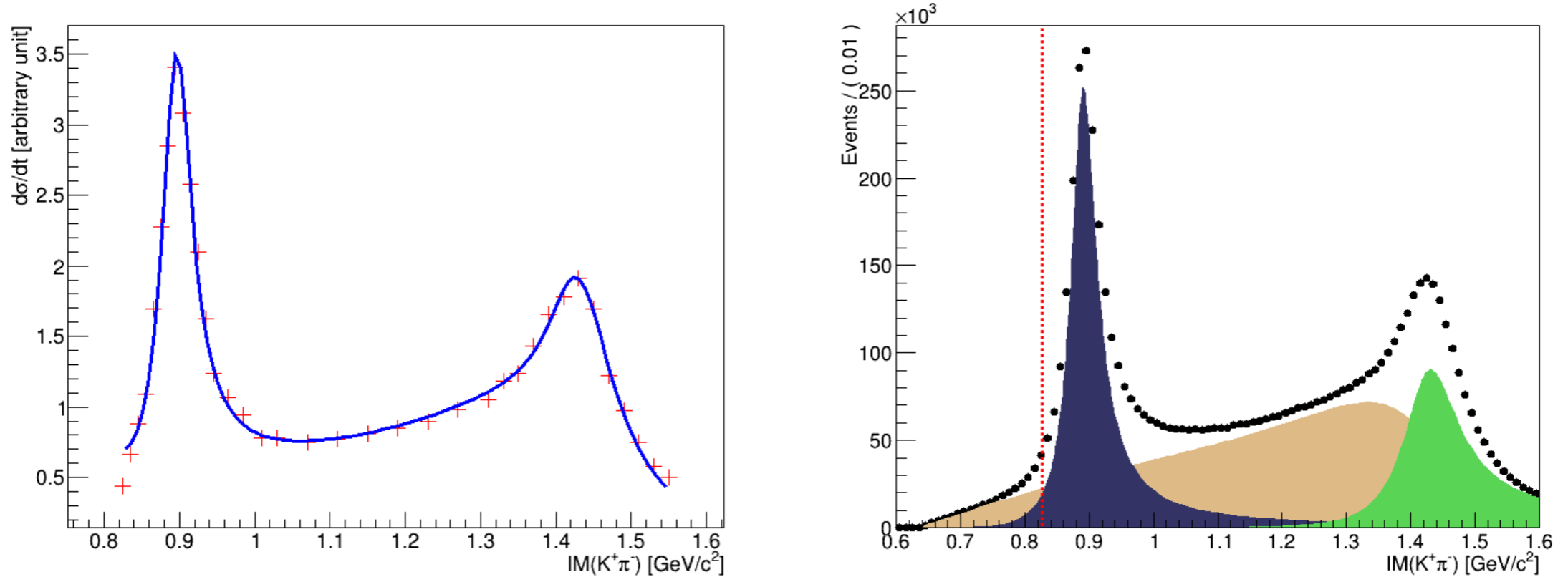

Figure 28: Left panel: Cross section of  $K^-p \rightarrow K^+\pi^-n$  as a function of the invariant mass from LASS results [122]. The blue line is the fit to the cross section using composite model containing two RBW, spin-1 and spin-2, and  $S$ -wave LASS parameterization. Right panel: Expected distribution of the  $K^+\pi^-$  invariant mass below 1.6 GeV from KLF after 100 days of run. The dark blue function represents the  $K^+\pi^-$   $P$ -wave, light brown the  $S$ -wave and green the  $D$ -wave. The dashed line represents the threshold of  $K\pi$  invariant mass in LASS results [122].

# Summary of $K\pi$ Scattering

- The KLF will have a very significant impact on our knowledg on  $K\pi$  scattering amplitudes
- It will certainly improve still conflictive determination of heavy  $K^*$ 's parameters
- It will help to settle the tension between phenomenological determinations of scattering lengths from data versus ChPT and LQCD
- Finally, and very importantly, it will reduce by more than a **factor of two** the uncertainty in the mass determination of  $K^*(800)$  and by **factor of five** the uncertainty on its width
- It will help to clarify debates of **its existence**, and therefore a long standing problem of existence **of the scalar meson nonet**

# PHYSICS WITH NEUTRAL KAON BEAM AT JLAB KL2016

FEBRUARY 1-3, 2016  
JEFFERSON LAB  
NEWPORT NEWS, VIRGINIA

## SCOPE

The Workshop is following Lo112-15-001 "Physics Opportunities with Secondary KL beam at JLab" and will be dedicated to the physics of hyperons produced by the kaon beam on unpolarized and polarized targets with GlueX set up in Hall D. The emphasis will be on the hyperon spectroscopy. Such studies could contribute to the existing scientific program on hadron spectroscopy at Jefferson Lab.

The Workshop will also aim at boosting the international collaboration, in particular between the US and EU research institutions and universities.

The Workshop would help to address the comments made by the PAC43, and to prepare the full proposal for the next PAC44.

## ORGANIZING COMMITTEE

Moskov Amaryan, ODU, chair  
Eugene Chudakov, JLab  
Curtis Meyer, CMU  
Michael Pennington, JLab  
James Ritman, Ruhr-Uni-Bochum & IKP Jülich  
Igor Strakovsky, GWU

[WWW.JLAB.ORG/CONFERENCES/KL2016](http://WWW.JLAB.ORG/CONFERENCES/KL2016)



# YSTAR Excited Hyperons in QCD Thermodynamics at Freeze-Out 2016

NOVEMBER 16-17, 2016

Jefferson Lab  
Newport News, Virginia

A workshop to discuss the influence of possible "missing" hyperon resonances (JLab KLF Project) on QCD thermodynamics, on freeze-out in heavy ion collisions and in the early universe, and in spectroscopy. Recent studies that compare lattice QCD calculations of thermodynamic calculations, statistical hadron resonance gas models, and ratios between measured yields of different hadron species in heavy ion collisions provide indirect evidence for the presence of "missing" resonances in all of these contexts. The aim of the workshop is to sharpen these comparisons, advance our understanding of the formation of baryons from quarks and gluons microseconds after the Big Bang and in today's experiments, and to connect these developments to experimental searches for direct, spectroscopic, evidence for these resonances. This Workshop is a successor to the recent KL2016 Workshop

## ORGANIZING COMMITTEE

Moskov Amaryan - Chair  
ODU  
Eugene Chudakov  
JLab  
Krishna Rajagopal  
MIT  
Claudia Ratti  
University of Houston

James Ritman, Ruhr  
U. Bochum & IKP Jülich  
Igor Strakovsky  
GWU



[WWW.JLAB.ORG/CONFERENCES/YSTAR2016/](http://WWW.JLAB.ORG/CONFERENCES/YSTAR2016/)



# HIPS 2017

New Opportunities with High-Intensity Photon Sources

February 6-7, 2017  
Catholic University of America  
Washington, DC U.S.A.

This workshop aims at producing an optimized photon source concept with potential increase of scientific output at Jefferson Lab, and at refining the science for hadron physics experiments benefiting from such a high-intensity photon source. The workshop is dedicated to bringing together the communities directly using such sources for photo-production experiments, or for conversion into K<sub>s</sub> beams. The combination of high precision calorimetry and high intensity photon sources can provide greatly enhanced scientific benefit to (deep) exclusive processes like wide-angle and time-like Compton scattering. Potential prospects of such a high-intensity source with modern polarized targets will also be discussed. The availability of K<sub>s</sub> beams would open new avenues for hadron spectroscopy, for example for the investigations of "missing" hyperon resonances, with potential impact on QCD thermodynamics and on freeze-out both in heavy ion collisions and the early universe.

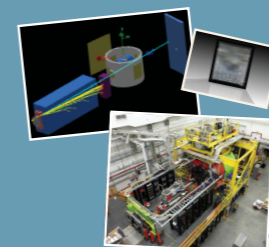

## Organizing Committee:

Taule Horn - CUA  
Cynthia Keppel - JLab  
Carlos Munoz-Camacho - IPNO  
Igor Strakovsky - GWU



Jefferson Lab

# π-K Interactions Workshop

## ORGANIZING COMMITTEE

Moskov Amaryan, ODU (Chair)  
U.-G. Meissner, U. Bonn/ITZ Jülich  
Curtis Meyer, CMU  
James Ritman, Ruhr-Uni-Bochum/ITZ Jülich  
Igor Strakovsky, GWU

February 14-15, 2018  
Jefferson Lab • Newport News, VA

The π-K scattering enables direct investigations of scalar and vector K\* states, including the not yet established S-wave K(800) state. These studies are also needed to get precise values of vector and scalar form factors: to independently extract CKM matrix element V<sub>us</sub> and to test the Standard Model unitarity relation in the first row of CKM matrix, to study CP violation from the Dalitz plot analysis of open charm D meson decays and in a charmless decays of B mesons in K<sub>s</sub> final states. Significant progress is made lately in Lattice QCD, in the phenomenology and in the Chiral Perturbation Theory to describe different aspects of π-K scattering. The main source of experimental data is based on experiments performed in SLAC almost five decades ago at 1970-80s. The recently proposed KL Facility incorporating the GlueX spectrometer at JLab will be able to improve the π-K scattering database by about three orders of magnitude in statistics. The workshop will discuss the necessity for and the impact of the future high statistics data obtained at JLab on π-K scattering.

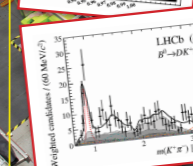
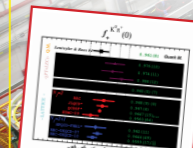
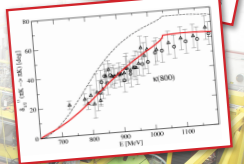
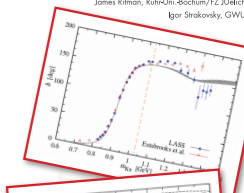

<https://www.jlab.org/conferences/pki2018/>

## KL2016

[60 people from 10 countries, 30 talks] <https://www.jlab.org/conferences/kl2016/>

OC: M. Amaryan, E. Chudakov, C. Meyer, M. Pennington, J. Ritman, & I. Strakovsky

## YSTAR2016

[71 people from 11 countries, 27 talks] <https://www.jlab.org/conferences/YSTAR2016/>

OC: M. Amaryan, E. Chudakov, K. Rajagopal, C. Ratti, J. Ritman, & I. Strakovsky

## HIPS2017

[43 people from 4 countries, 19 talks] <https://www.jlab.org/conferences/HIPS2017/>

OC: T. Horn, C. Keppel, C. Munoz-Camacho, & I. Strakovsky

## PKI2018

[48 people from 9 countries, 27 talks] <http://www.jlab.org/conferences/pki2018/>

OC: M. Amaryan, U.-G. Meissner, C. Meyer, J. Ritman, & I. Strakovsky

# In total: 222 participants & 103 talks

# SUMMARY

- -Proposed KL Facility has a unique capability to improve existing world database up to three orders of magnitude
- -In Hyperon spectroscopy  
PWA will allow to unravel and measure pole positions and widths of dozens of new excited hyperon states
- -In Strange Meson Spectroscopy  
PWA will allow to measure excited  $K^*$  states including scalar  $K$
- KLF Project will have a strong impact on  
-Thermodynamics of an Early Universe

Summary: ***From TAC Report***

*Feasibility:* The project appears to be technically feasible. The cost (without local labor) was estimated at about \$6M (taking into account the recent CPS estimate), including about \$1M for the Flux Monitor, which may become a foreign contribution.

# PAC47 Final Report

**Scientific Rating:** N/A

**Recommendation:** C2

**Title:** “Strange Hadron Spectroscopy with a Secondary  $K_L$  Beam in Hall D”

**Spokespersons:** M. Amaryan (contact), M. Bashkanov, S. Dobbs, J. Ritman, J. Stevens, I. Strakovsky

**Motivation:** The spectroscopy of strange baryons and mesons, including their fundamental strong interactions, is the focus of this proposal. New and unique data can be obtained with an intense  $K_L$  beam aimed at a hydrogen/deuterium target, using the GlueX apparatus to detect final state particles.

**Measurement and Feasibility:** The most significant technical aspect of this proposal is the addition of a Compact Photon Source (CPS) in the beamline leading into Hall D, which will have significant attendant cost and will impose an estimated six months changeover time for alternate running of GlueX. It is also important to be sure that GlueX can handle the background rates from neutrons and other beam-induced contaminants. It seems quite feasible that the GlueX detector can manage to detect the final state particles with enough particle discrimination to meet the spectroscopy needs.

**Issues:** Several points of discussion concerned the PAC. A) the missing mass technique to replace the direct proton detection at very low values of  $|t|$  was only presented in the open session and the details of the underlying simulations should be clarified; B) a realistic simulation including beam backgrounds is to be presented with details to be spelled out and documented thoroughly; C) A realistic project management plan needs to be developed to realize the experiment; D) The analysis and extraction of key physics parameters requires theory guidance, which is now included within the group of proposing authors and makes use of JPAC.

This facility will add a new physics reach to JLab, and the PAC is looking forward to see the idea being materialized, in conjunction with the plans for Hall D as spelled out in the white paper provided to us.

**Summary:** The collaboration should return to the PAC with a well documented proposal. Simulations addressing backgrounds and the low  $|t|$  region are necessary. Also, a well-formed plan is needed to build the beamline and prepare for data taking with GlueX.

***Thank you !***