



Hall D K-Long Facility E12-19-001.

Experiment Readiness Review Phase I.

Jefferson Lab , 2023 Charge and Brief Answers.

- Is there any R&D needed to be done prior to start the construction of the KLong Facility? **No.**
- What is the status of the Compact Photon Source (CPS)? Specifically the
- 1. Conceptual design: Presented below.
- 2. **Approximations** in the MC simulations and Code used: Simplified Tagger & KPT Halls. FLUKA2021.2.9.
12 GeV beam $3.1E+13$ e/s, ($5\mu A$), FWHM=**2.5 mm**,
< **1 mrem/hr** on top of Tagger Hall and Tunnel Mounds.
- 3. Evaluation of the **produced radiation**: < **2 kW/cm³** , Cu Absorber < **220°C** , **Pb** shield < **110°C**.
- 4. Energy deposition , **Absorber** and **Lead temperature**:
- 5. Prompt **dose** and **activation** around the CPS (Tagger Hall): Dose < **10 rad/hr** , < **20 mrem/hr**. Maps available.
- 6. **Magnet** and **insulation lifetime**: 0.25×0.5 Tm, $I \leq 1.8$ kA, wire 2×2 cm², T<**150°C**, LT=**15** years.
- 7. **Cooling system** & **ground waters contaminations**: Tritium Activity **2.6×10^7 Bq** & **200 Bq/L** after 1 year.
 - What will the photon **beam quality** be: ~ **$2.E+13$ γ /s**, FWHM=4 cm, neutrons & \pm part<**2%** .
 - **Cost and schedule estimates** for the construction of the CPS: **\$800,000** without magnet.
 - **Civil constructions** to contain the radiation in the Tagger Hall: **No.**
 - **Decommissioning Plan** for CPS and Activated Components: To be mounted on rails to **move aside** for storage.



Compact Photon Source and K_L Beam for Hall D.

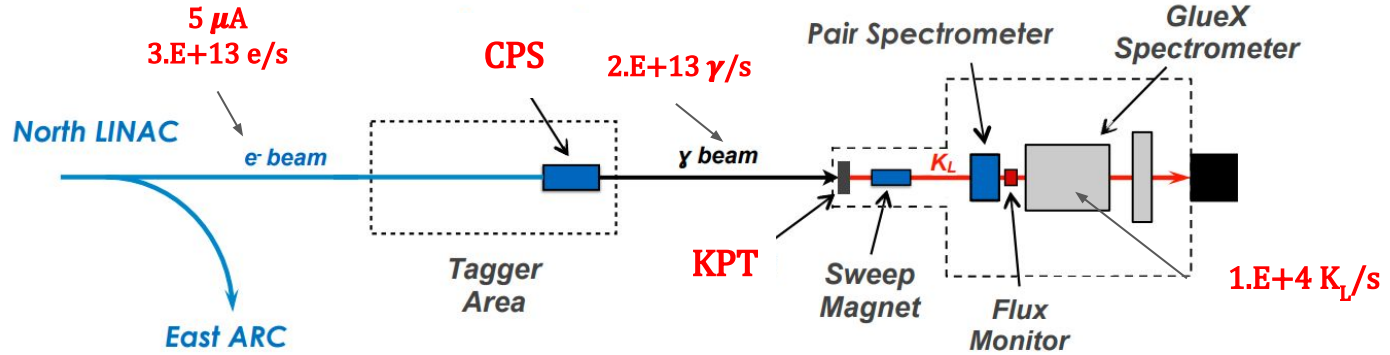

Strange Hadron Spectroscopy with Secondary K_L beam in Hall D



Moskov Amaryan

Old Dominion University
Norfolk, VA, USA

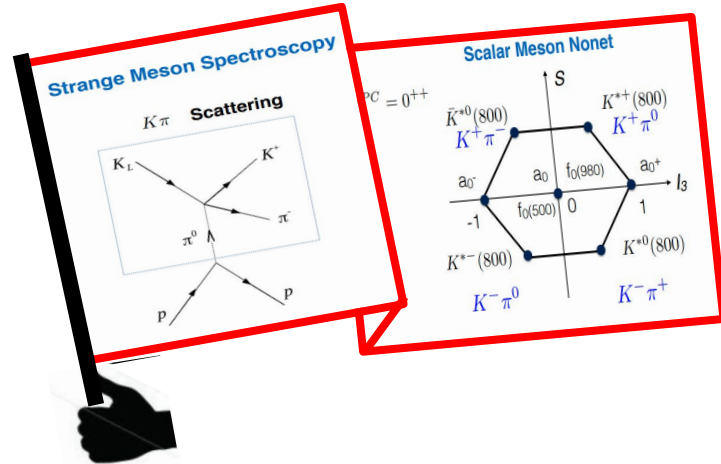



CPS Conceptual design and Simulations using FLUKA

(12 GeV electrons, $3.1 \times 10^{13} \text{ s}^{-1}$, 5 μA , FWHM=2.5 mm.)

M. Amaryan¹, M. Bashkanov², V. Baturin¹, W. J. Briscoe³, E. Chudakov⁴, P. Degtyarenko⁴,
S. Dobbs⁵, H. Egiyan⁴, Ilya Larin⁶, A. Somov⁴, I. Strakovsky³ & T. Whitlatch⁴.

(1) Old Dominion University, (2) York University,
(3) The George Washington University, (4) TJNAF, (5) Florida State University,
(6) University of Massachusetts, Amherst.

Outline

1. **CPS** in FLUKA. **Location, Design, and Alignment** .
2. **Radiation** and **Temperature** inside **CPS**.
3. Photon **Beam Quality**.
4. **Radiation** in CPS Magnet and **Lifetime of Coil Insulation**.
5. Prompt **Dose and Activation** around CPS.
6. Tritium **Contamination** in Soil and Cooling Waters.
7. **Lifetime of** construction **materials**.
8. Conclusion and Outlook.

CPS Conceptual Design and Simulations

using FLUKA 2021.2.9

Model approximations.

TITLE ... BEAMPOS : 6 cards h ... len ...

PHOTONUC Type: **Quasi D off** All E On **Giant Dipole off** Step

PHYSICS Type: **EM-DISSO** EM Disso Proj+Target EM-Disso **Plons: 1000**
 Type: **PEATHRES** Nucleons: 1000 (Anti)Hyperons: 1000
 Kaons: 1000
 Kaonbars: 1000
 AntiNucleon: 1000

PHYSICS Type: **IONSPPLIT** Ion Split On **Splitting Probabilistic** Amax: 2
 Emin: 0.01
 Transport: HEAVYION

IONTRANS PROBLEM WITH AMA VBT101422

PHYSICS Type: **IONSPPLIT** Ion Split On **Splitting Probabilistic** Amax: 2
 Emin: 0.1
 Type: **DPMTHTRES** Emin: 20000
 Emin ions RQMD: 0.125 Smearing +/-AE: 0.5 Smearing +/-AE: 10000
 Type: **QMDTHRES** Emin(BME): 0
 BME-RQMD: .125

VBT101422 Type: **ISOMERS** Explicit Isomers On

PHYSICS Type: **ISOMERS** Explicit Isomers On

LOW-NEUT n-groups: 260 y-groups: 42 Emax: 0.02
 Print: Point Wise Everywhere (n,f) Multiplicity: default

LOW-MAT Mat: LITHU-6 LowMat: 6LL Lithium 6, 296K
 Min step (cm):
 Bx: 0 Bound Acc. (cm): By: 0

PHYSICS ... PHYSICS : 6 cards hidden

LOW-NEUT n-groups: 260 y-groups: 42 Emax: 0.02
 Print: Point Wise Everywhere (n,f) Multiplicity: default

UMGNFIELD Max Ang (deg): Bx: 0 Bound Acc. (cm): By: 0
 TgZoff: :200.0
 TgYAzmAng: :0.0

TIME-CUT Tcut: 100000 Telsy: Start Mat: Step:
 Part: to Part: +

EMFCUT Type: transport e-e+ Ekin: 0.0007 y: 0.0007
 Reg: BORATE to Reg: @LASTREG Step:

EMFCUT Type: PROD-CUT e-e+ Ekin: 0.0007 y: 0.0007
 Mat: BLCKHOLE to Mat: @LASTMAT Step:

Fudgem: 1.E-05
 Relevant to DCYSCORE . If Decays=Active then DCYSCORE WHAT1==1.1 Analytical decay treatment.

RADDECAY Decays: Active Patch Isom: On Replicas: 3
 hNu Int: ignore hNu LPB: ignore e-e+ Int: ignore
 e-e+ WW: ignore Low-n Bias: ignore Low-n WW: ignore
 e-e+ LPB: ignore decay cut: 0.0 prompt cut: 0.0 Coulomb corr: y

ASSIGNMA ... ASSIGNMA : 110 cards hidden

Beam Irradiation time is 1000 Hrs = 360000 s 1.6875E+13 particles per second = 2.7 microAmp beam current 3.125E+13[e/s]= 5 micro Amperes

IRRRPROF Δt: 3600000 p1: 3.125E+13
 Δt: p1:
 Δt: p1:
 Δt: p1:

DCYTIMES t1: 3600 t2: 86400 t3: 604800
 t4: 2592000 t5: t6:

CPS location in Tagger Hall. Beam $5 \mu\text{A}$, Gaussian, FWHM=2.5 mm.

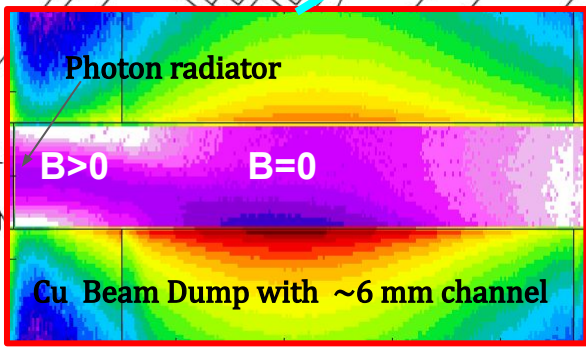
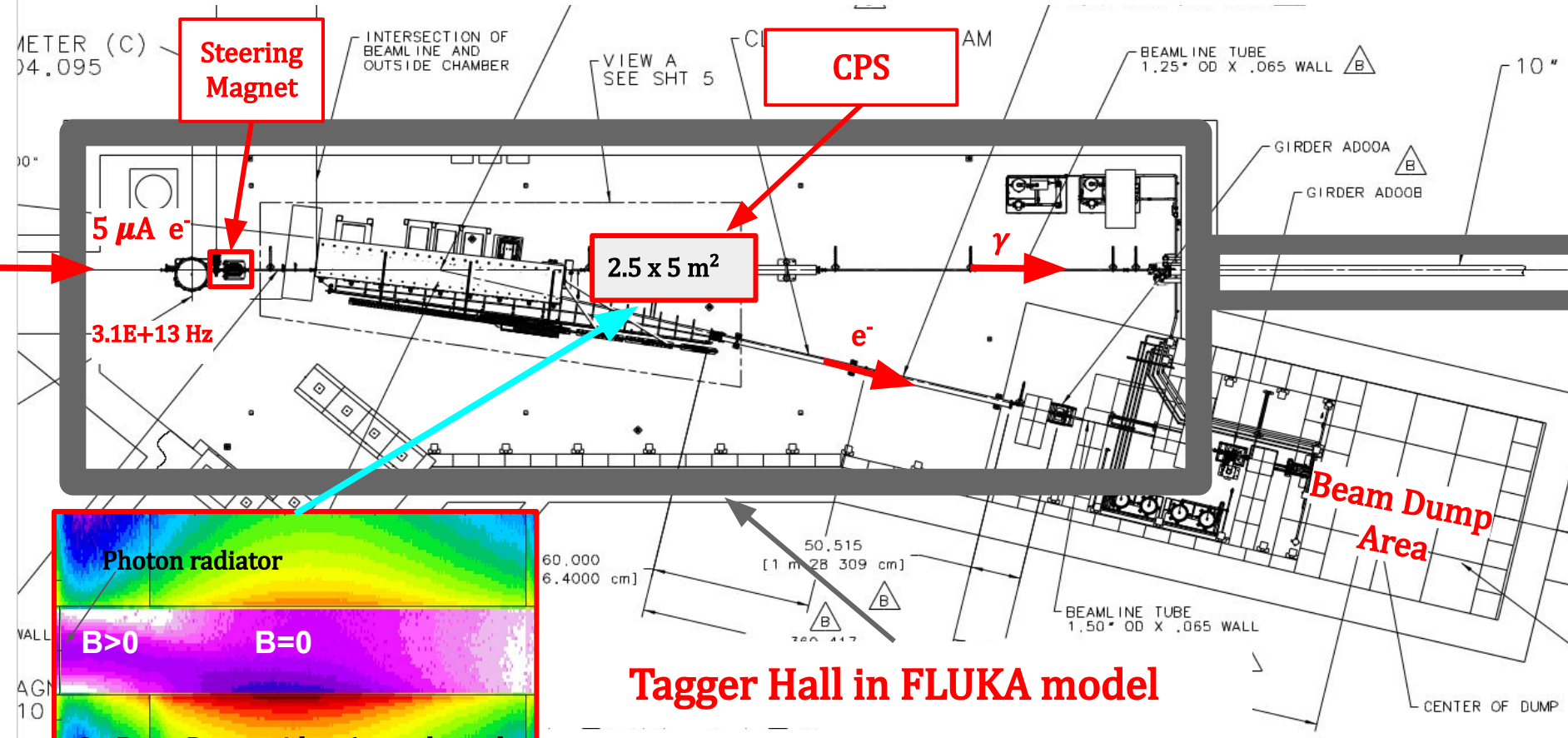

Tagger Hall in FLUKA model

CPS, Tagger Hall, KPT and Magnet Prototype in FLUKA model.

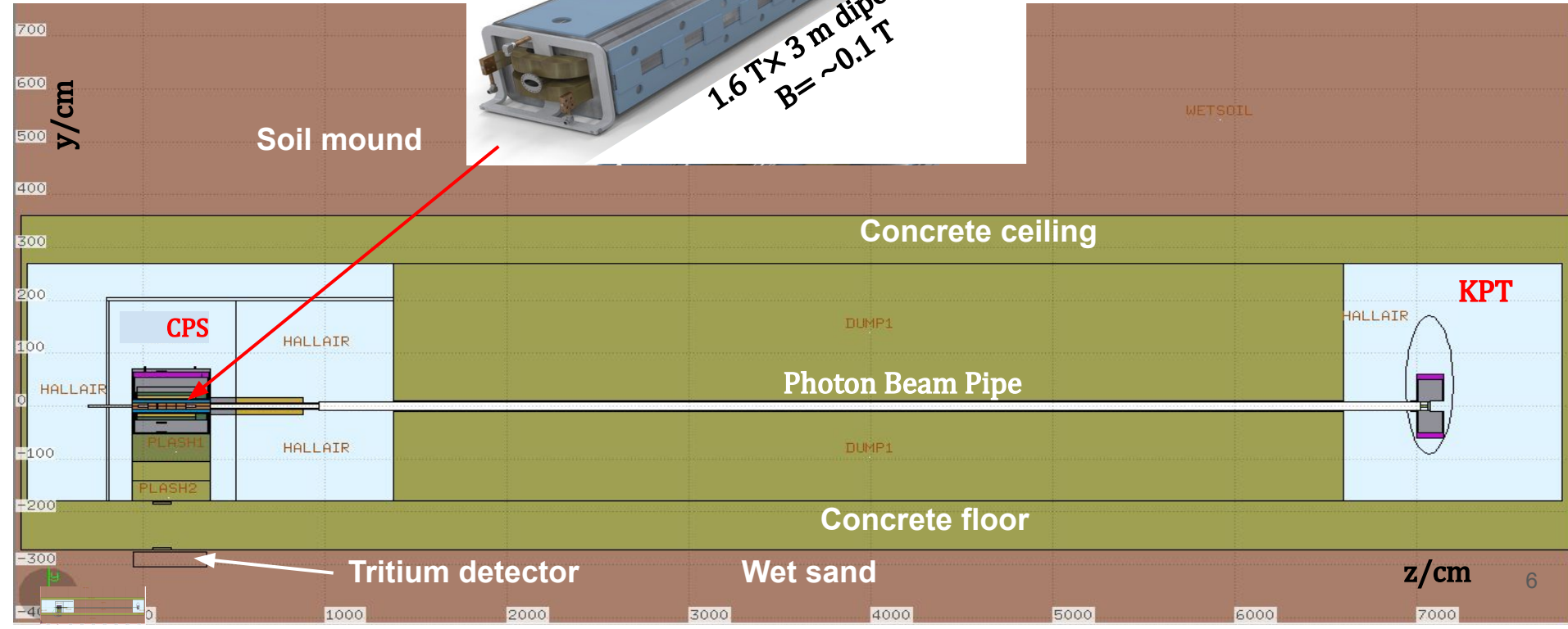
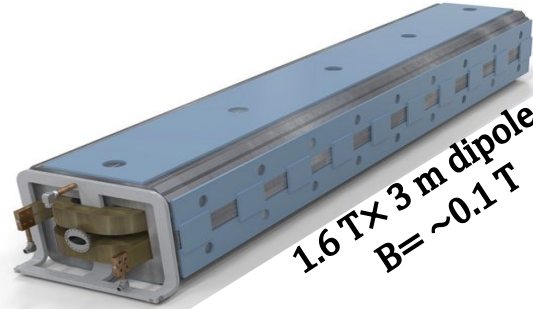

CPS in FLUKA: Magnet Yoke/platform, Two Coils, Cu Absorber, and 4 shield layers.

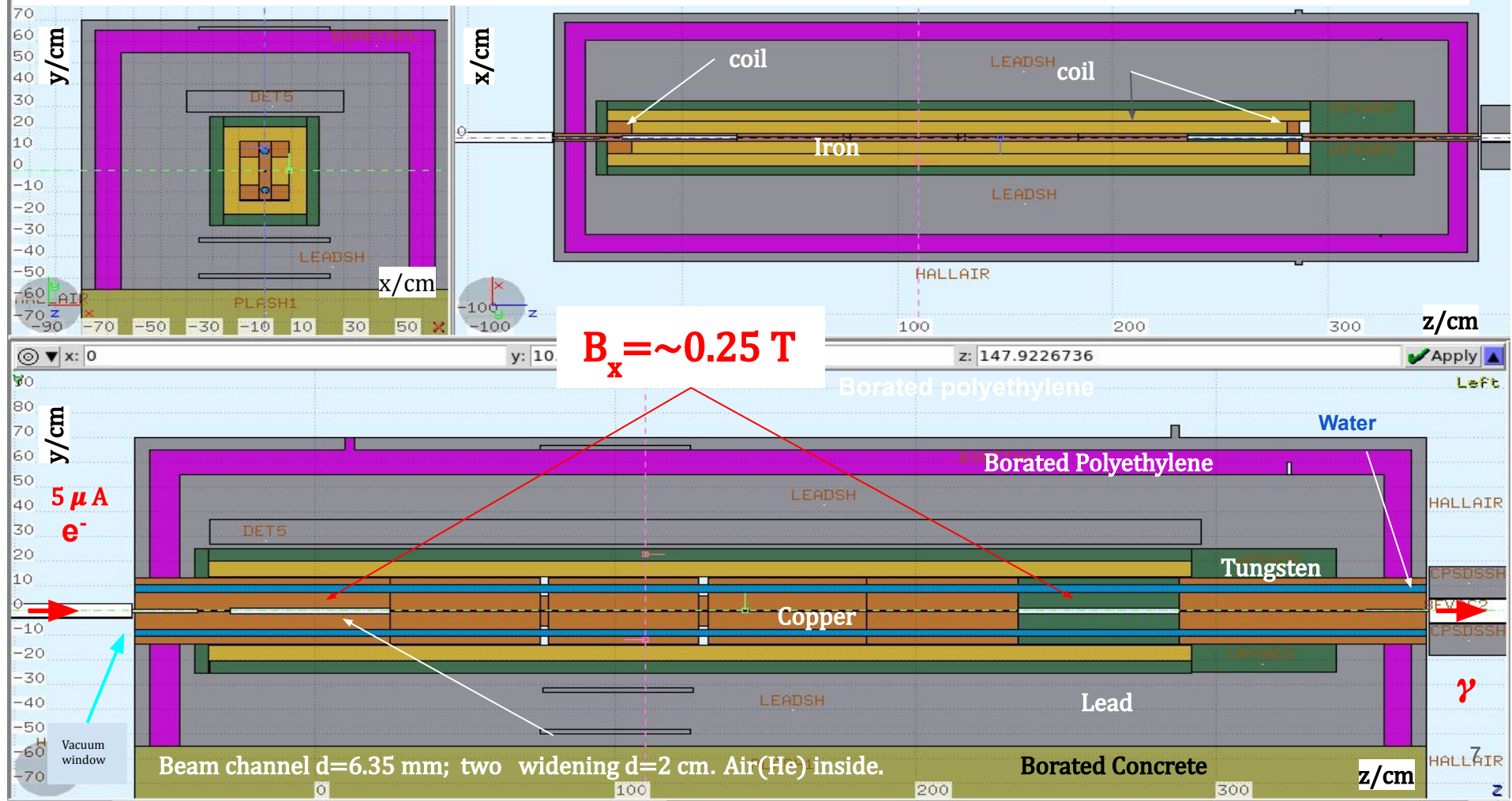

Source of radiation. Hot spot in the absorber. Power deposition

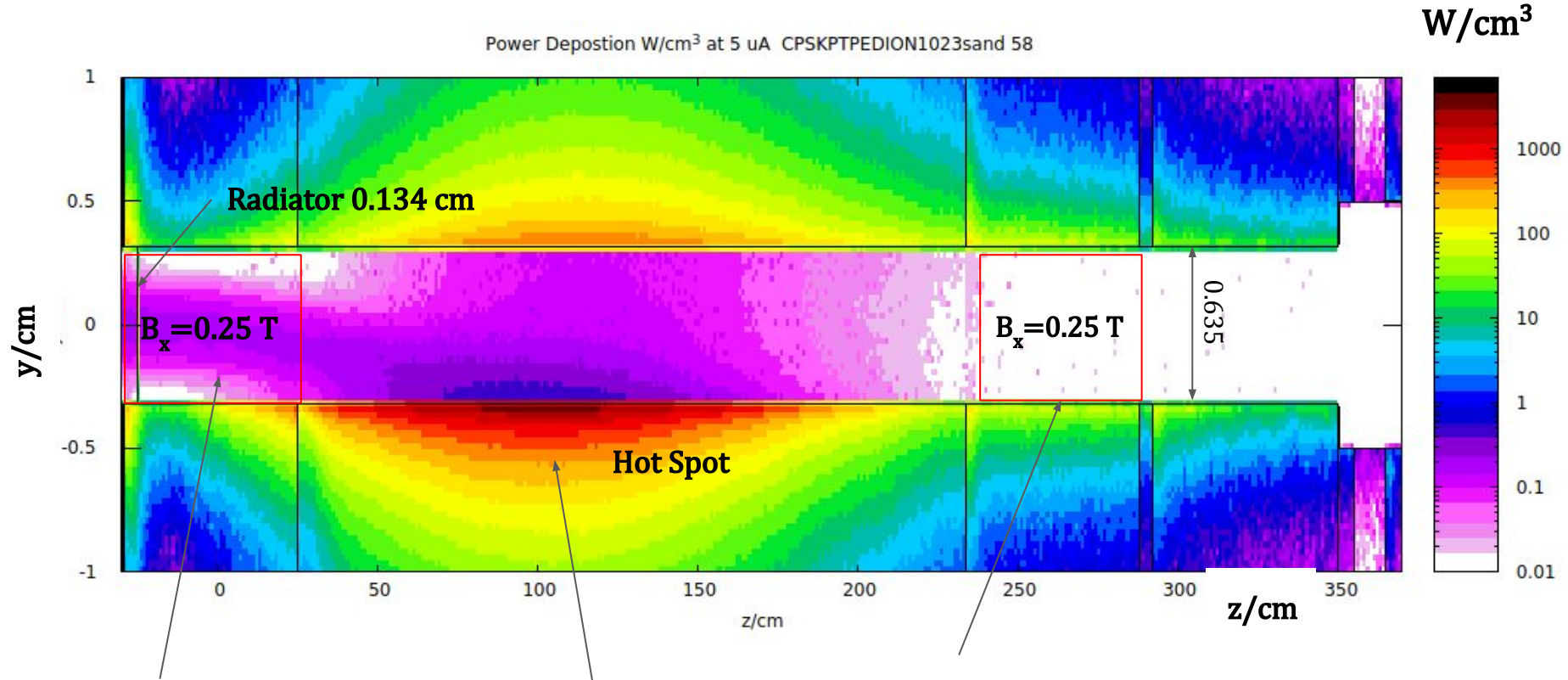

- Upstream magnet forms the Hot Spot; Downstream - cleans the photon beam.
- The **wider** is the Hot Spot - **the lower** is deposited power/temperature in the maximum.

Magnetic Field, Beam Channel, and Hot Spot Size.

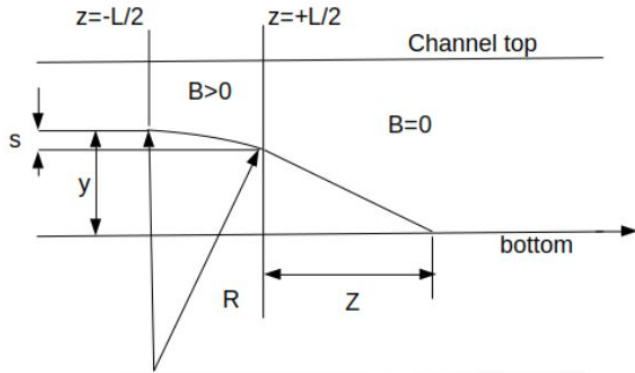

y -electron entry coordinate.

R -trajectory radius, $R \propto B^{-1}$.

z -counts from $L/2$ - coil area length, where $B > 0$.

z' -counts from $z = 0$.

L_M - length of **Beam Channel and Absorber**.

$\langle z' \rangle = L_M/2$ is constrained to be in the middle of Channel.

From two triangles on this figure we find:

$$(R - s)^2 + L^2 = R^2, \quad \Rightarrow \quad s \approx \frac{L^2}{2R},$$

$$\frac{L}{R - y} = \frac{y - s}{z},$$

$$z \approx \frac{R}{L}(y - s) = \frac{R}{L}y - \frac{L}{2},$$

$$\langle z' \rangle \approx \langle y \rangle \frac{R}{L},$$

$$\text{rms}(z') \approx \text{rms}(y) \frac{R}{L} = \langle z' \rangle \frac{\text{rms}(y)}{\langle y \rangle}.$$

$$\text{rms}(z') = 2 \langle z' \rangle \frac{\text{rms}(y)}{d} = \frac{L_M}{d} \text{rms}(y)$$

- At given **rms(y)** and **channel length L_M** for a **lower power** deposition and temperature **reduce** channel diameter.
- However, keep $d > d_{\min} \approx 2 \text{rms}(y)$, otherwise beam tail hits the Channel.

CPS Absorber and Alignment.

Segmented Copper Absorber - possible solution.

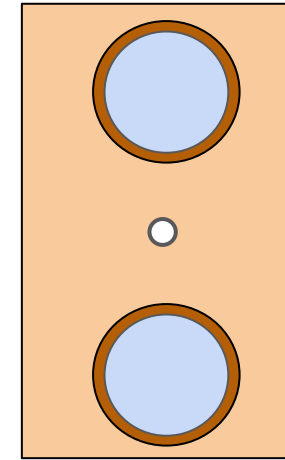
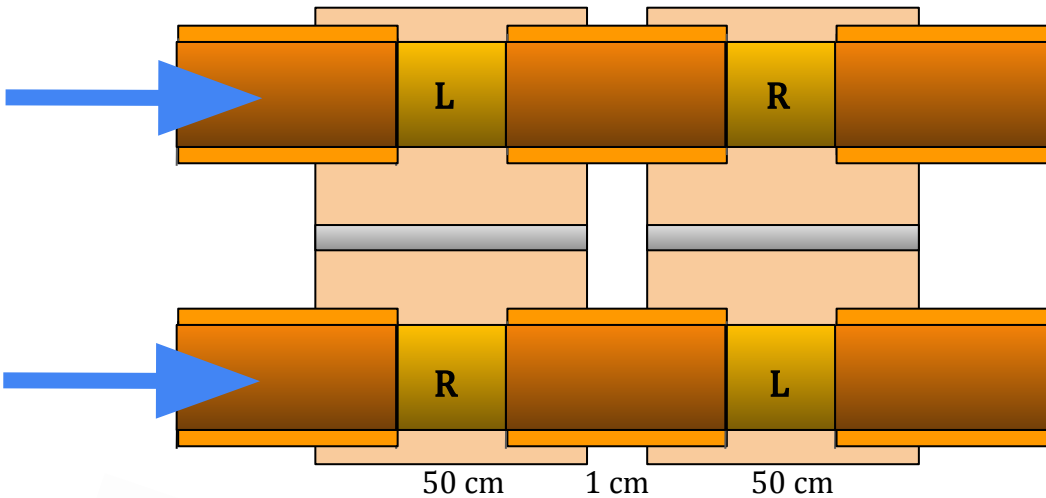

23 cm

4.4 cm



- Segments $\sim 4.4 \times 20 \times 50 \text{ cm}^3$, **round beam hole**. \Rightarrow Advantage compared square holes.
- (1) No problem of **thermal contact** between 2 parts (if squared hole) and (2) may be **vacuumized**.
- Segments are connected by fittings with **left/right-hand threads**; may be **brazed**.
- Provides direct **copper-water contact** inside segments: \Rightarrow no interface; **better cooling**.



Magnet Yoke as Precise Platform for Absorber

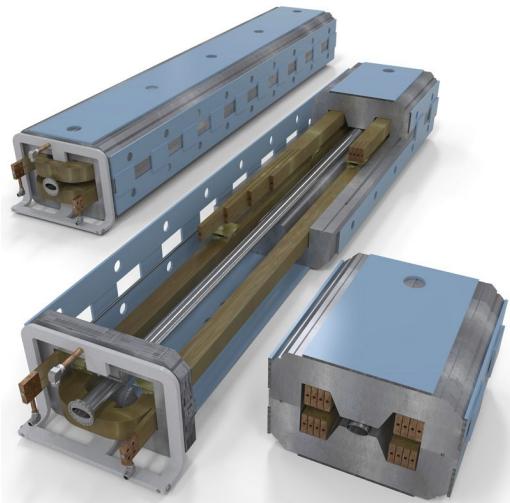

Fermilab Beamline Dipole 1.6×3 Tm,
 $I_{max} = 1.8$ kA, Cooling ~20 kW.

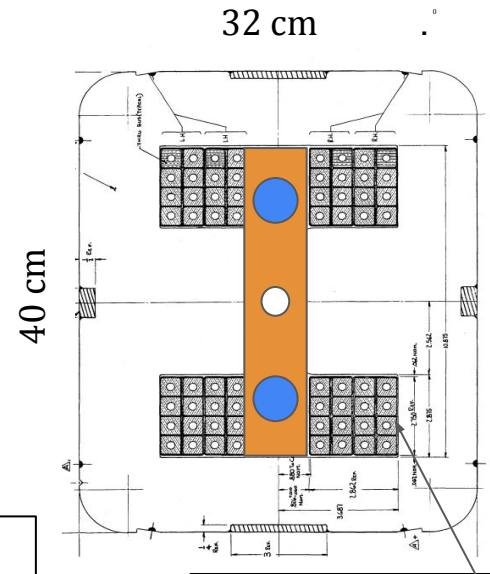

$B = 1.6$ T - 16 wires 1.7×1.7 cm²
 $B \leq 0.6$ T - 6 wires.

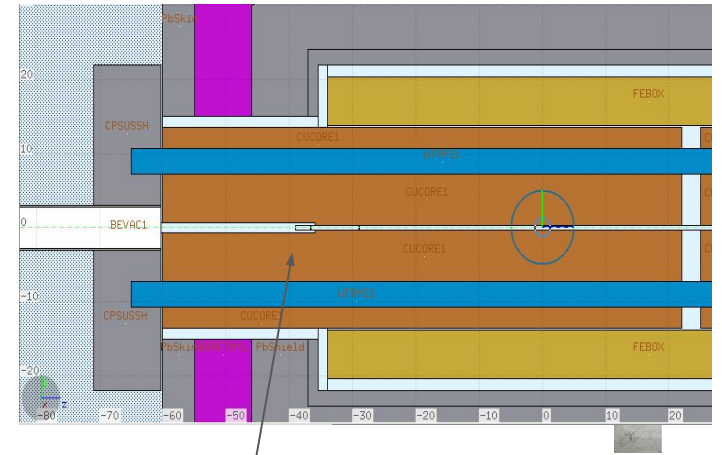

1. **Iron shield** and **precision platform** for Absorber. Specified **flatness** within **500 μm**.
2. **Housing** for all parts with narrow beam channels, including protruded segments.
3. **Precision Assembling** at a bench and **in-hall Alignment** with **5 DOF** only.

Energy deposition
and
Temperature of CPS components.

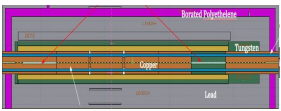

Power Deposition in $-0.5 < x/cm < 0.5$ layer. Coarse mesh 0.5 cm.

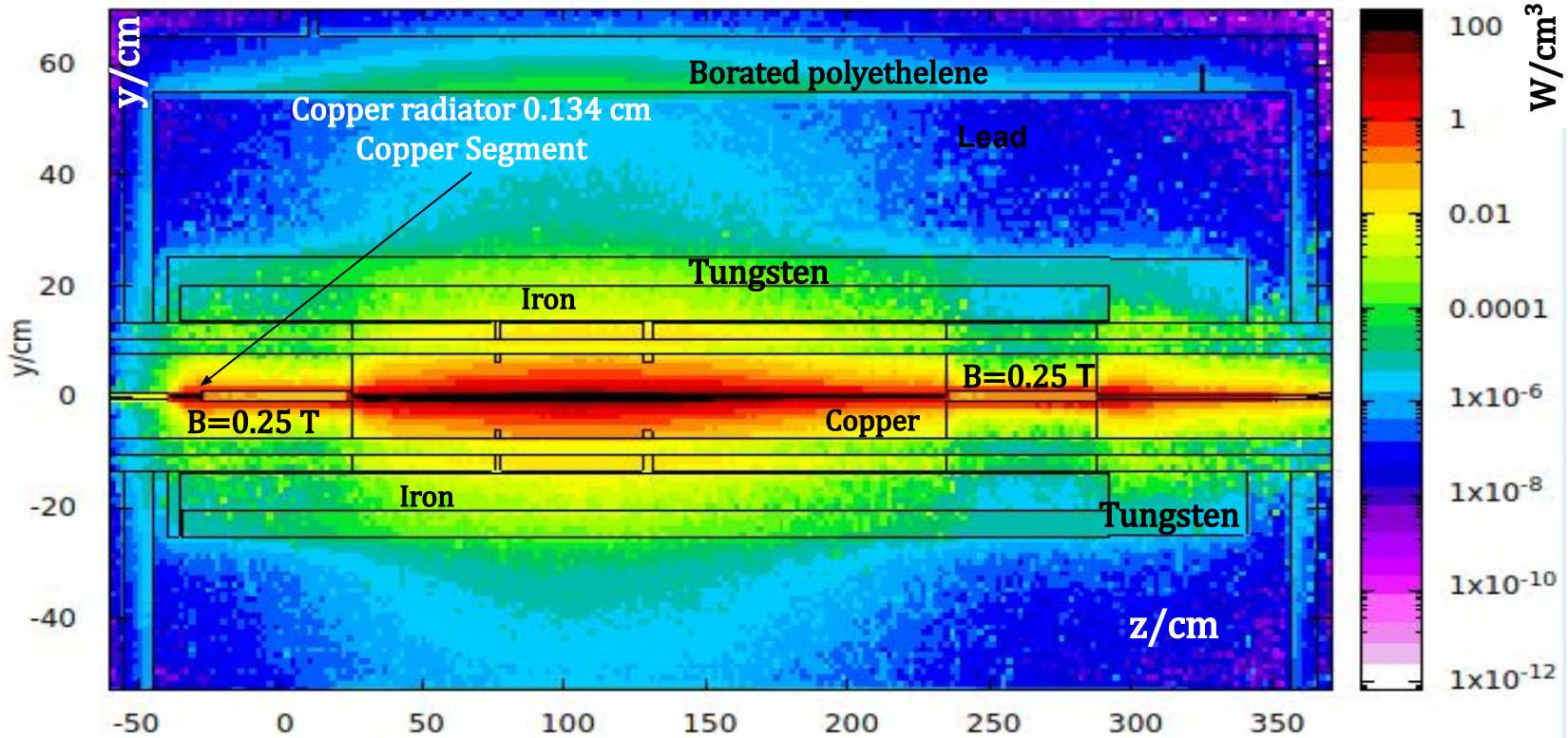

- Protruding **copper segment** around Radiator to mitigate lead overheating.
- T^0 -calculations **in progress**. Channel widening in coil area - to **reduce dose** rates.

Power breakdown between CPS components .

CPS part	GeV/e	kW/5 μ A
DS Shield (W)	0.063	0.316
US Shield (W)	0.033	0.163
Side Shield (W)	0.013	0.064
Top Water Pipe	0.001	0.005
Bottom Pipe	0.001	0.006
Magnet Pole Right	0.322	1.610
Magnet Pole Left	0.321	1.619
Coils	0.058	0.289
Magnet Yoke	0.101	0.504
Lead Shield	0.006	0.032
Polyethylene (B)	0.002	0.011
Lead Skin	0.001	0.004
Converter (Cu)	0.002	0.010
Total	0.923	4.620

Segment	GeV/e	kW/5 μ A
1 W/Cu	0.230	1.151
2	2.013	10.077
3	4.743	23.744
4	2.034	10.183
5	0.385	1.929
6 W/Cu	0.164	0.822
Radiator	0.002	0.010
Total	9.571	47.916

- **Total deposition 53 kW out of 60 kW of e-beam.**

Temperature field in the entire CPS at thermal contact between Shield Layers via 100 micron Air.

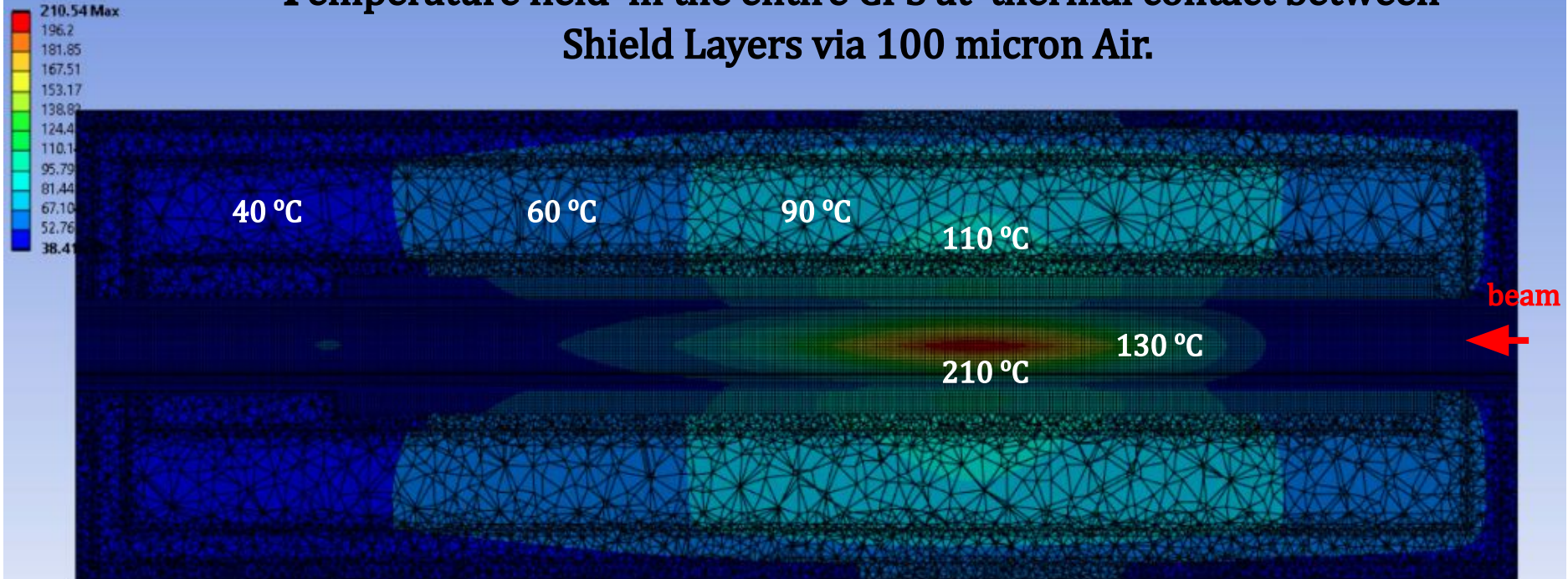

- Copper $T < 210^{\circ}\text{C}$ ($T_m = 1084^{\circ}\text{C}$). Absorber Channel does not melt.
- Lead $T < 110^{\circ}\text{C}$. ($T_m = 327^{\circ}\text{C}$). Lead Shield does not melt.
- Iron $T < 150^{\circ}\text{C}$. ($T_m = 1538^{\circ}\text{C}$). $T < 150^{\circ}\text{C}$. Cooling not required.

Power Deposition in Hot Segment . Fine mesh 0.05 cm

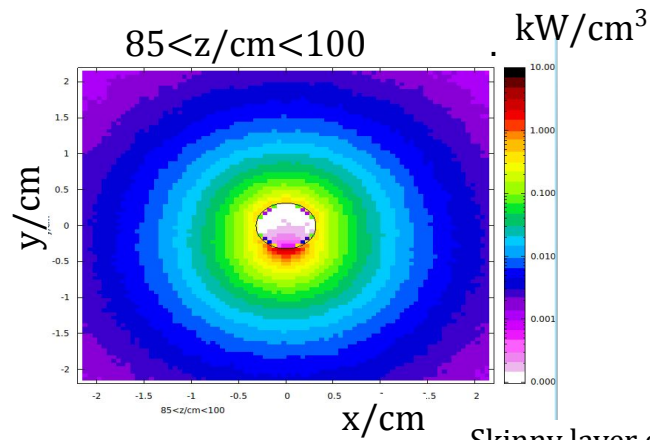
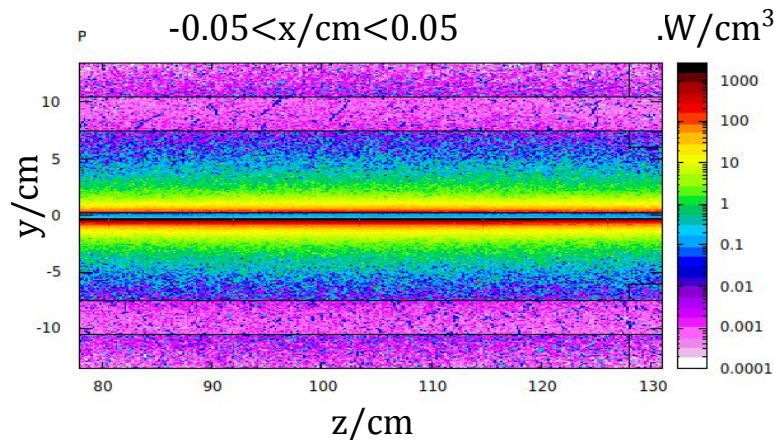

- Maximum $dP/dV = \sim 2 \text{ kW}/\text{cm}^3$
- **Temperature calculations** are done by Tim Whitlatch (JLab) using ANSYS and this Power Deposition Map.

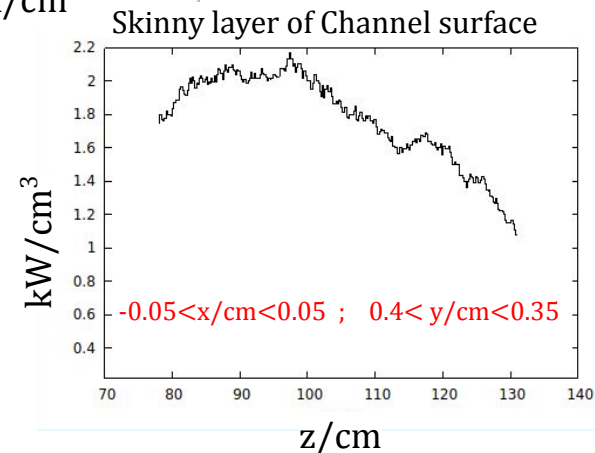

Calculation by Tim Whitlatch

Temperature field in the Hot Segment at Heat Transfer Coefficient $9 \text{ kW/m}^2\text{C}$.

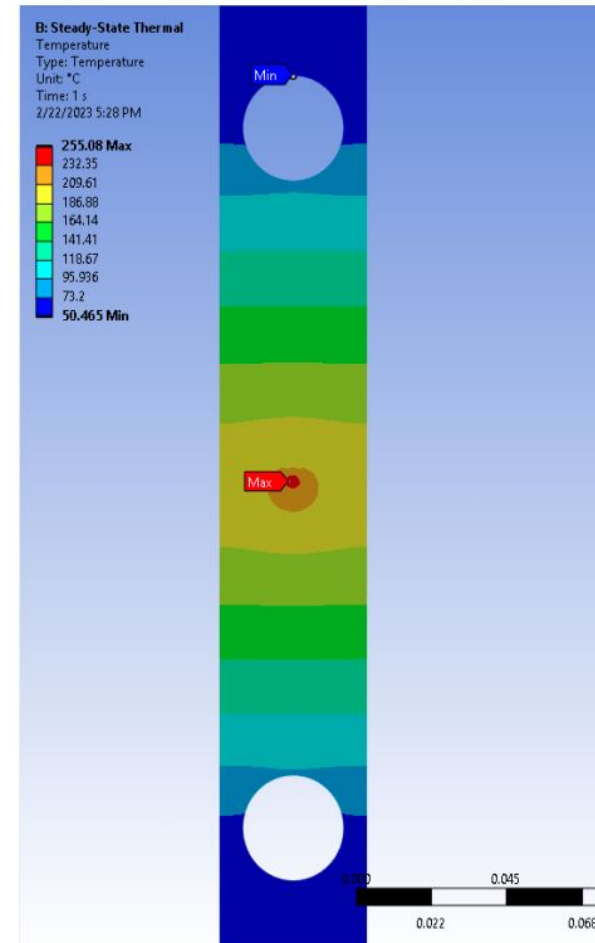
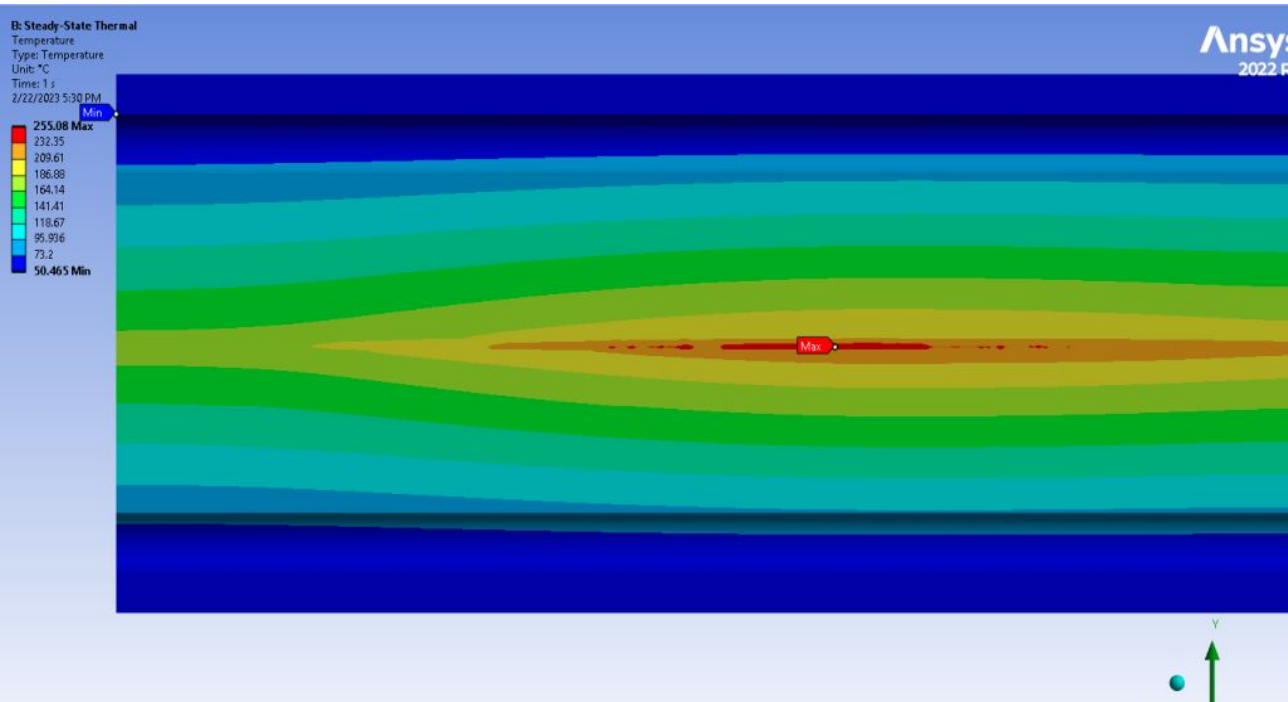

“Hot” Absorber (Cu), 53 cm long, 6.35mm Beam Hole with Air,
30 mm Water Channel ($9 \text{ kW/m}^2\text{C}$) evacuates 29 kW at $T_{\text{water}} \sim 40 \text{ }^\circ\text{C}$.

- Maximum Copper Temperature $255 \text{ }^\circ\text{C}$ (melts at $1,084 \text{ }^\circ\text{C}$).

Photon Beam Quality at KPT

Particles exiting from the CPS . Angular profile.

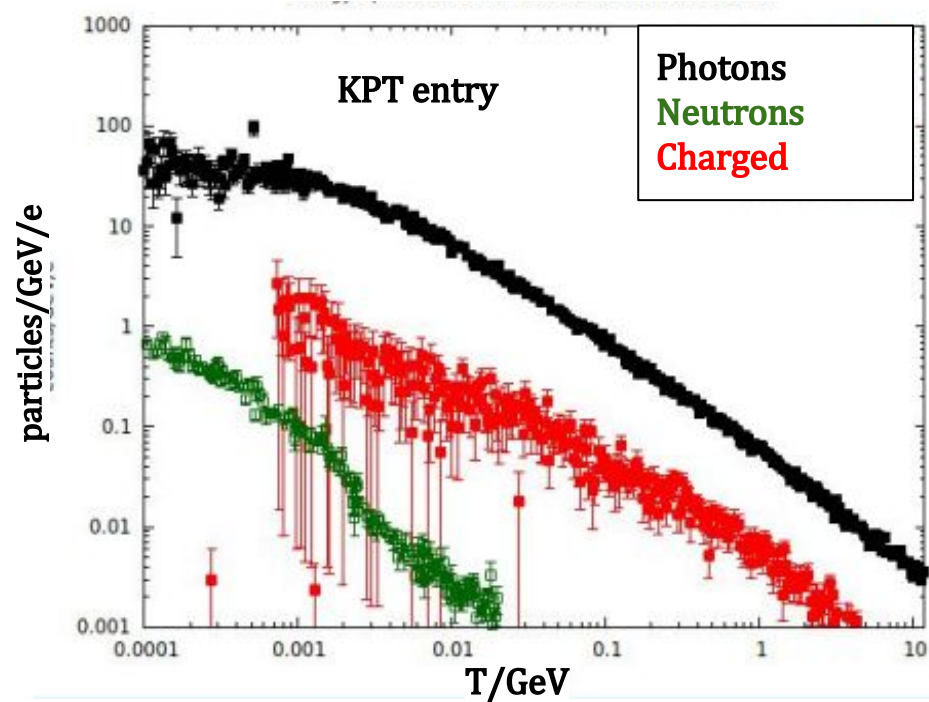
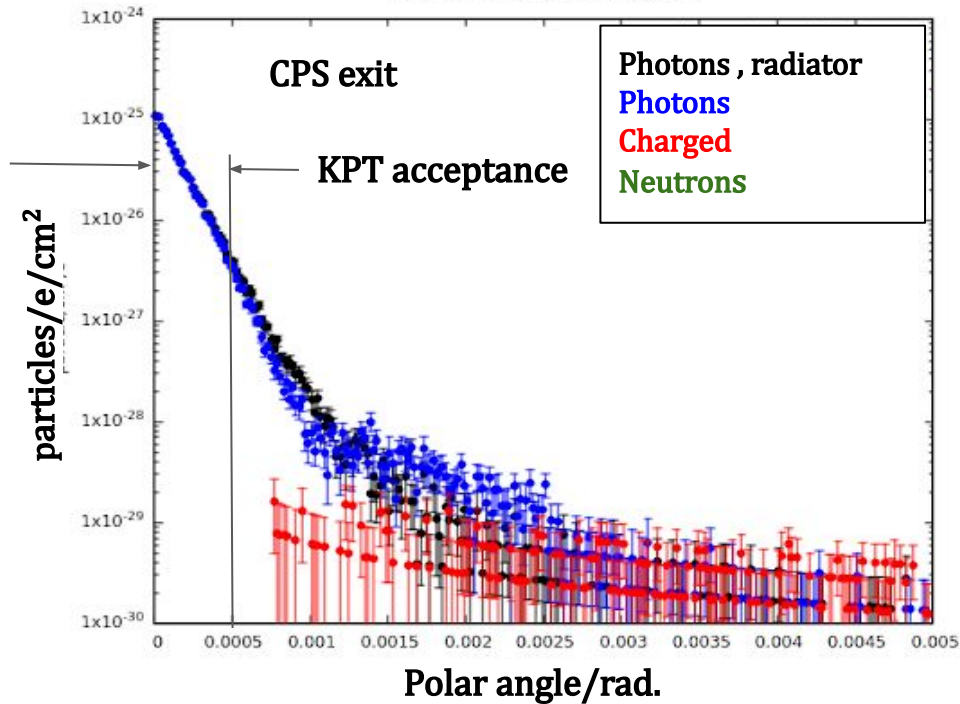

- Photon beam at the CPS exit **looks very clean** ($< 1.E-3$). Left plot.
- What happens to the beam **after 67 m of beam line?** - Right plot.

Beam quality at KPT.

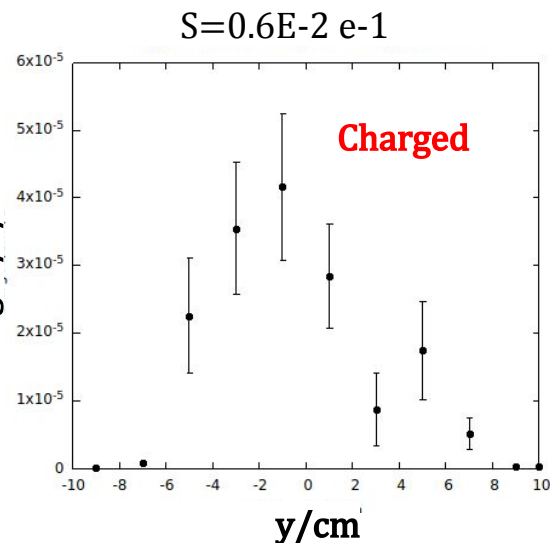
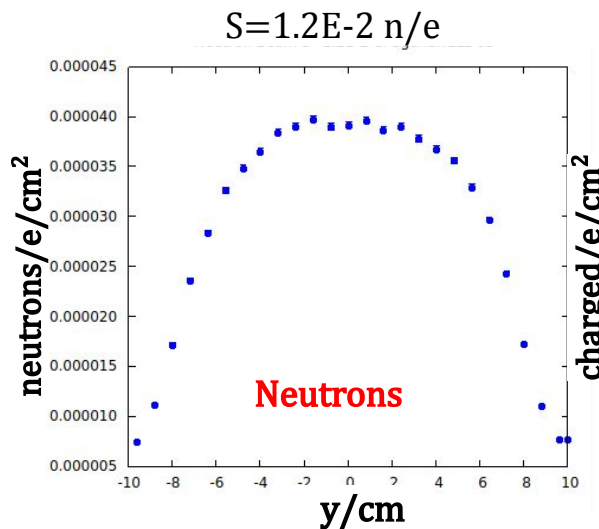
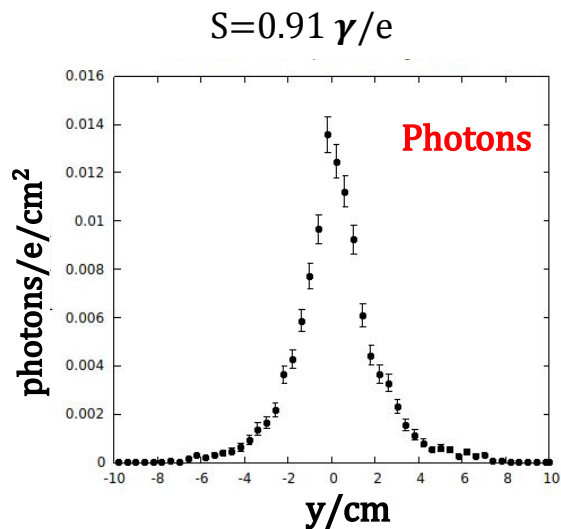

- After 67 m of beam line the total **background** of charged particles and neutrons is of **2. %**.
- Be target acceptance $r=2.5 \text{ cm}$; \Rightarrow **80%** of photon beam hits the Be target of KPT.
- Photon beam **intensity at KPT entry** $\sim 2.8 \text{ E}+13 \text{ photons/s}$.

Energy deposition in KPT. Effect of photon beam.

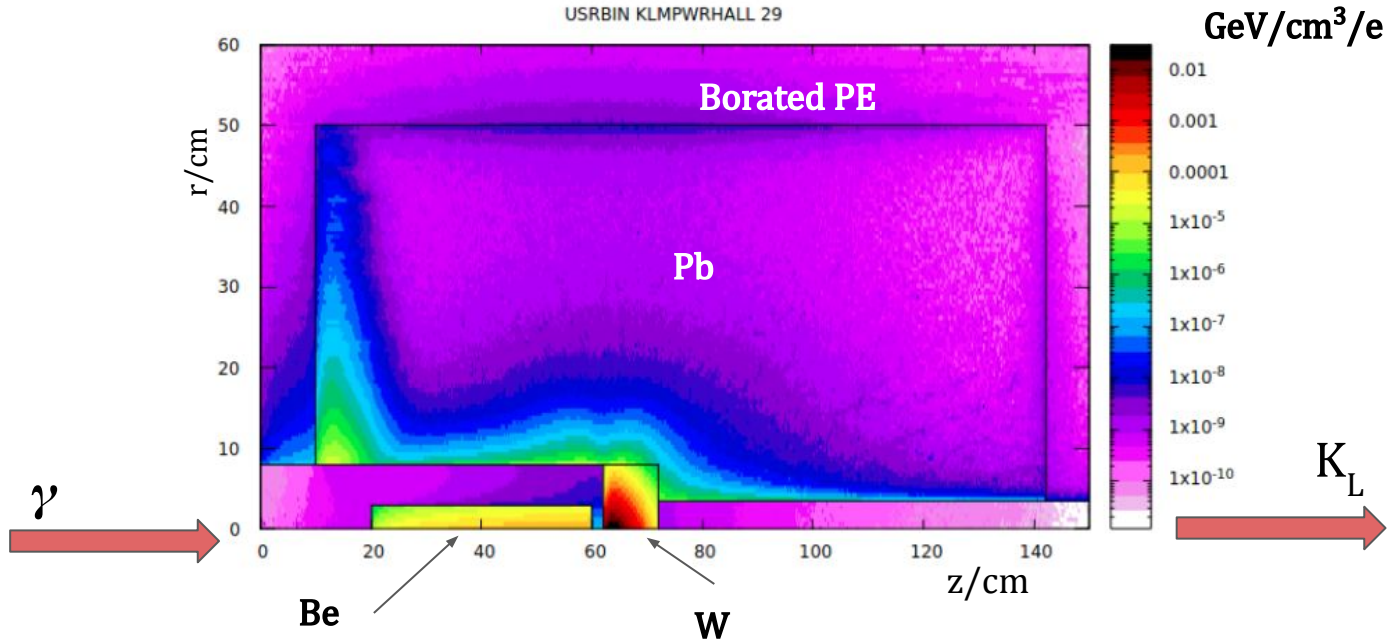

22

- T^0 -field is **calculated** using this map and **cooling** system **designed** by T. Whitlatch.

K_L from KPT and on H_2 -target of GlueX detector.

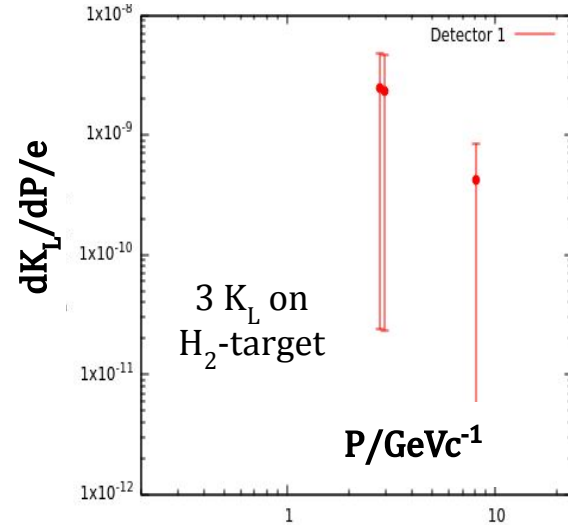
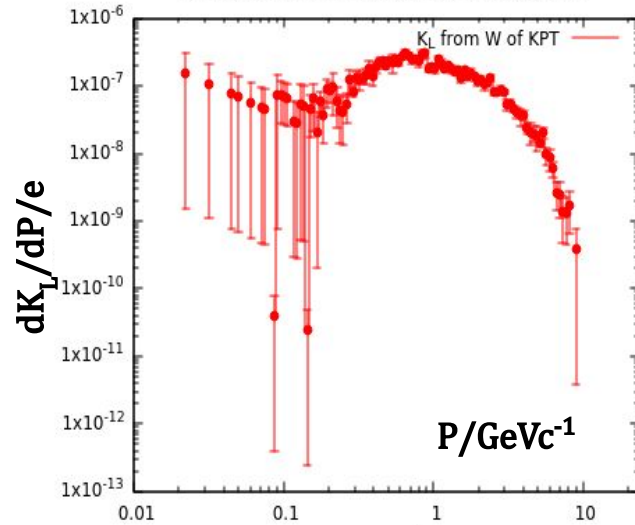

- K_L beam **intensity** on H_2 -target ($\Delta\Omega = 1.3E-3$ sr) is not a primary goal.
- From the right plot we may estimate it on H_2 target: $dK_L/dt \sim 10^4$ Hz.
- **Agrees** with the **KLF proposal**.

Radiation in CPS Magnet and Coil insulation lifetime.

For a closed shielding can : $S = 4/3 \mu t/D$ where μ - the permeability (relative) t : material thickness D : Shielding Diameter.

For a long hollow cylinder in a magnetic transverse field : $S = \mu t/D$.

For a cubic shielding box : $S = 4/5 \mu t/a$; a - box side length.

Coil Design and Insulation Exposure to Radiation.

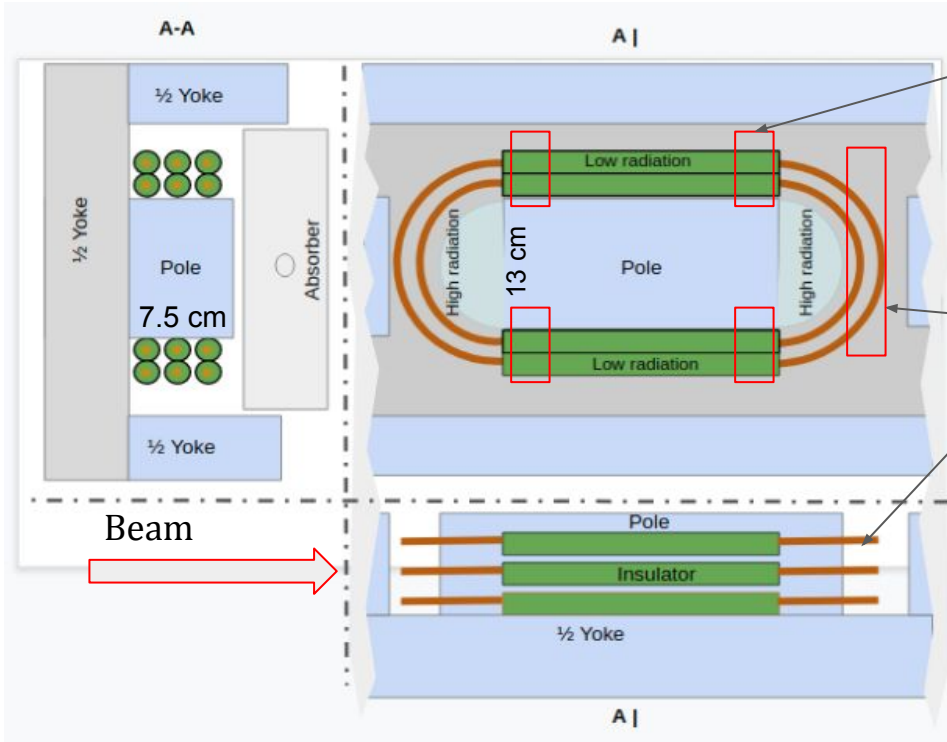

Hot area for insulation.

Very hot area,
Air insulation,
Gap between
wires
~8 mm.

Ampere's force law:

$$dF/dl = (\mu_0 / 2\pi) (I^2/d) = \sim 25 \text{ N/m}$$

at $I=1800 \text{ A}$; $d=2.5 \text{ cm}$; $\mu_0=4\pi \times 10^{-7} \text{ N/A}^2$

- Attractive force of bent parts $F = 25 \text{ N/m} * 0.3 \text{ m} = 7.5 \text{ N}$.
- Copper 1.7 cm -wires (tubes) will not touch. Attractive deformation $\sim 12 \text{ microns only!}$

Prompt Dose in Coils and Insulation Lifetime (straight part).

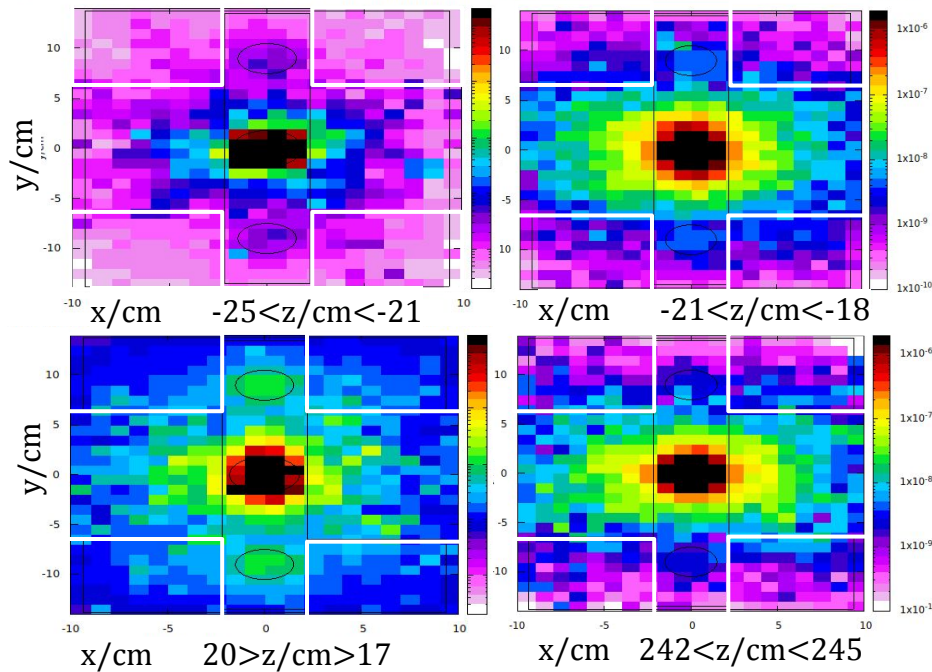

- Dose $2.E-8 \text{ GeV/g/e} \times 1.6E-10 \text{ J/GeV} = 3.2E-18 \text{ Jg}^{-1}\text{e}^{-1} = 3.2E-15 \text{ Gy/e}$;
- Translates to $3.2E-15 \text{ [Gy/e]} \times 3.E+13 \text{ [e/s]} \cong 0.1 \text{ [Gy/s]}$.
- Fiberglass cloth withstands **50 MGy** => **Lifetime** = $5.E+8 \text{ s} = 15 \text{ years}$.
- Bent part dose rate is ~ 10 times higher.

Benefit of wider magnet (+14 cm).

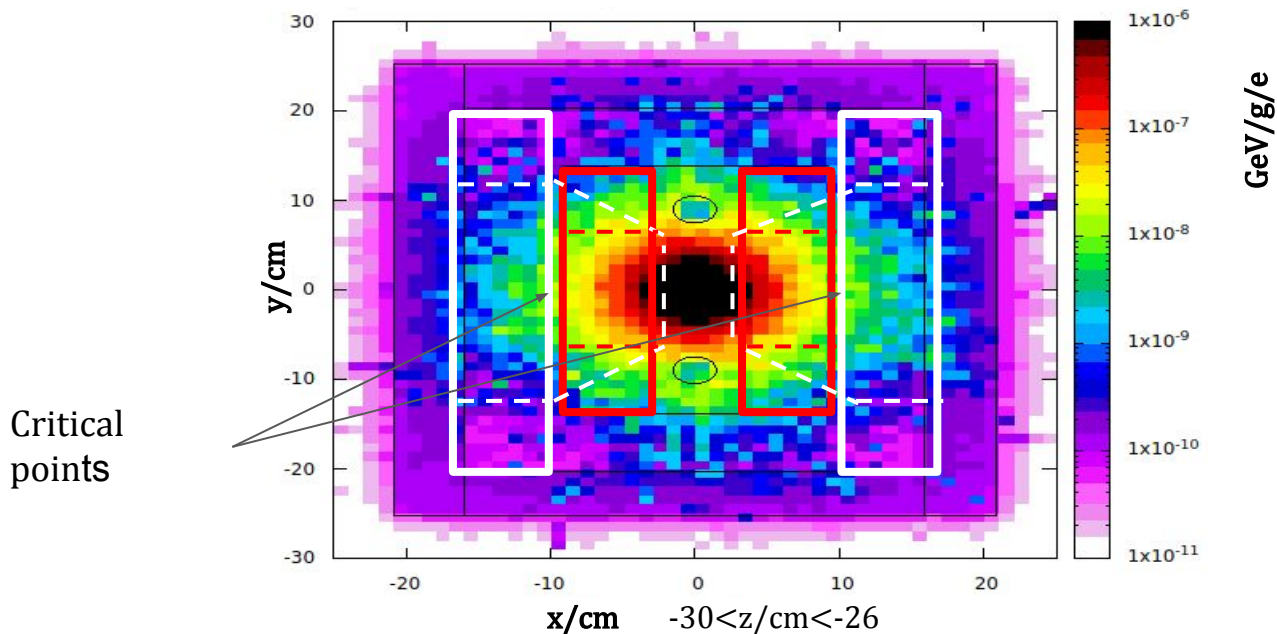

- Dose rate in critical points **0.1 Gy/s (2.E-8 GeV/g/e)**.
- For 14 cm wider Magnet Insulation Lifetime in Coil return area is of **15 years**.

Tim Whitlatch's solution.

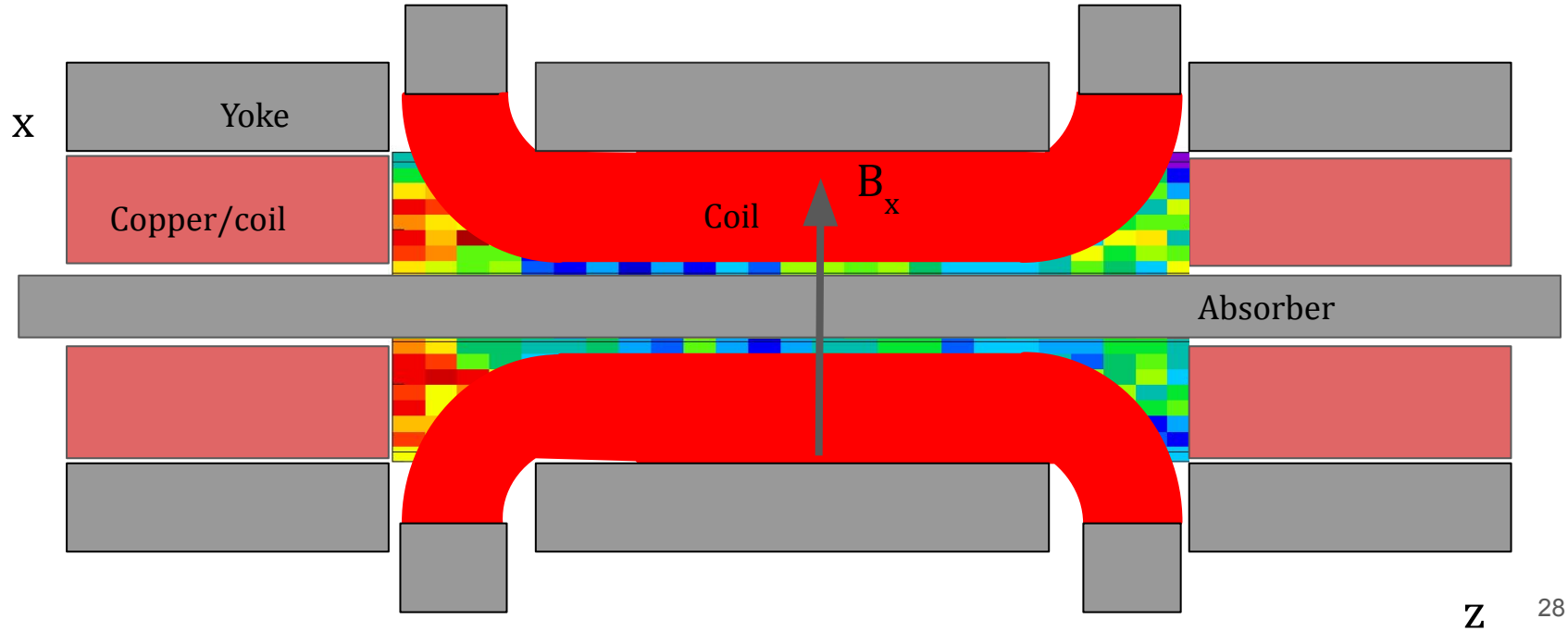

Prompt Dose (equipment)
and
Activation (human)
around CPS

Prompt Dose Rate around CPS < 10 rad/hr . Effect of Tail shield .

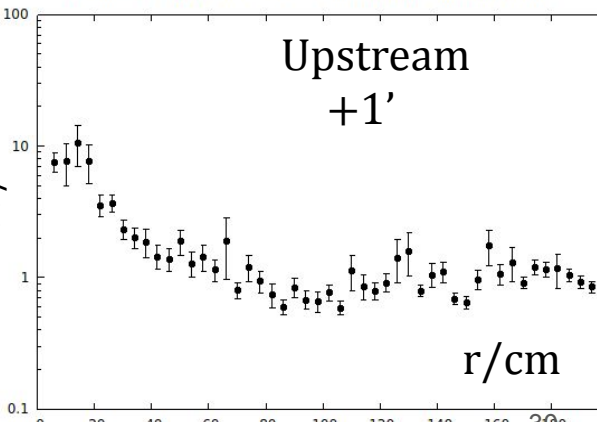
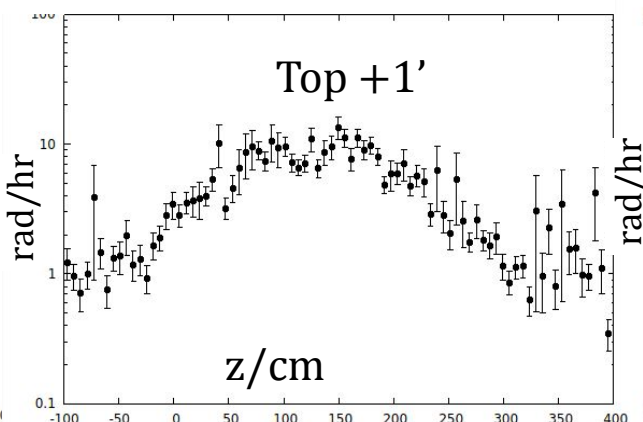
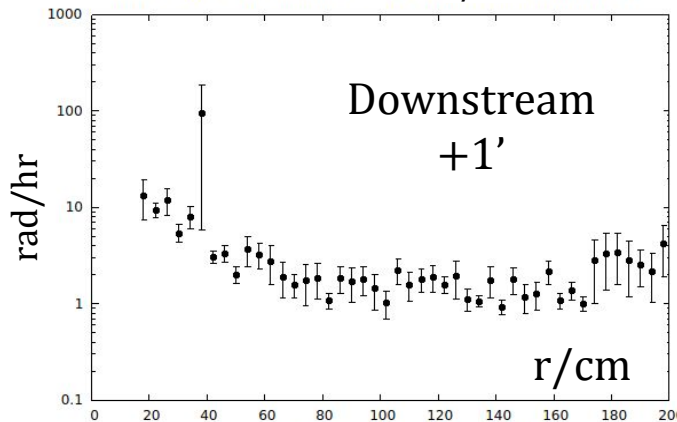
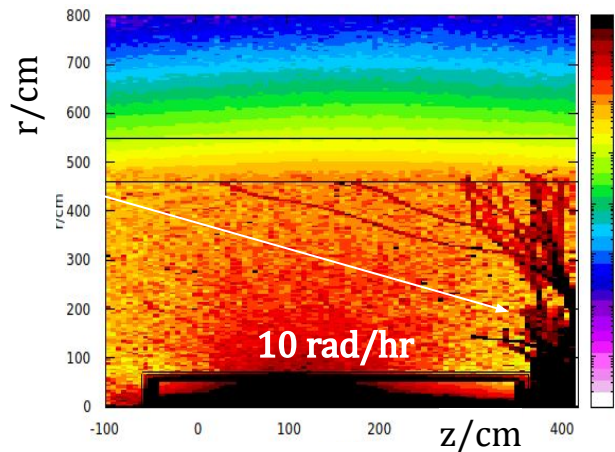
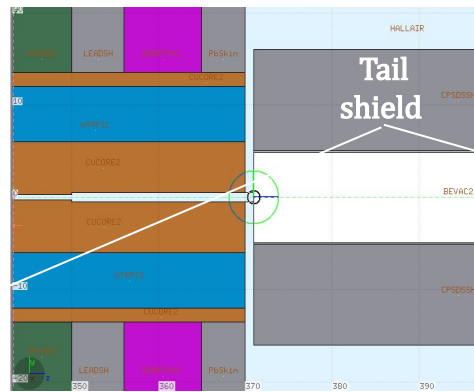
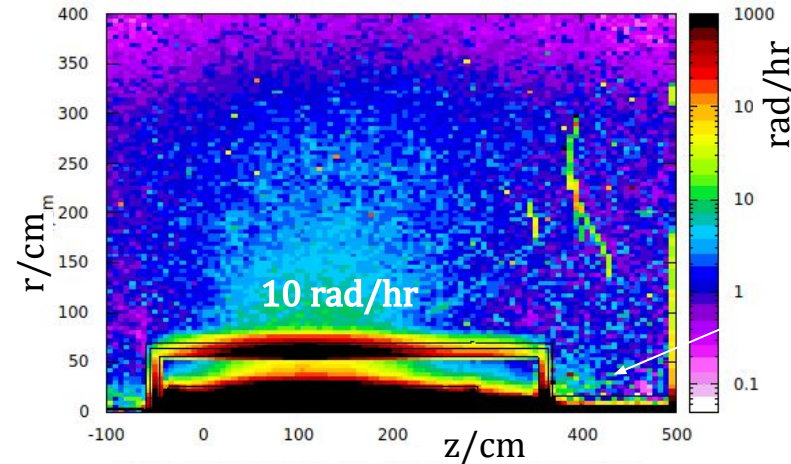

Activation After 1000+1 hr < 20 mrem/hr.

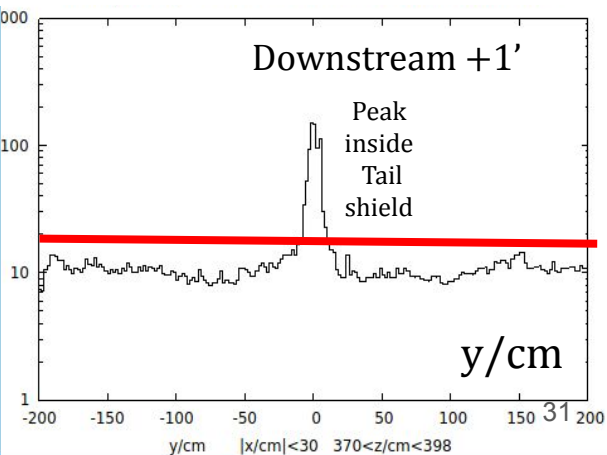
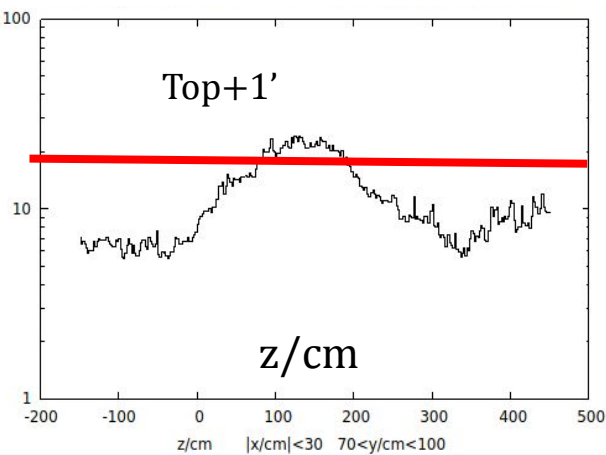
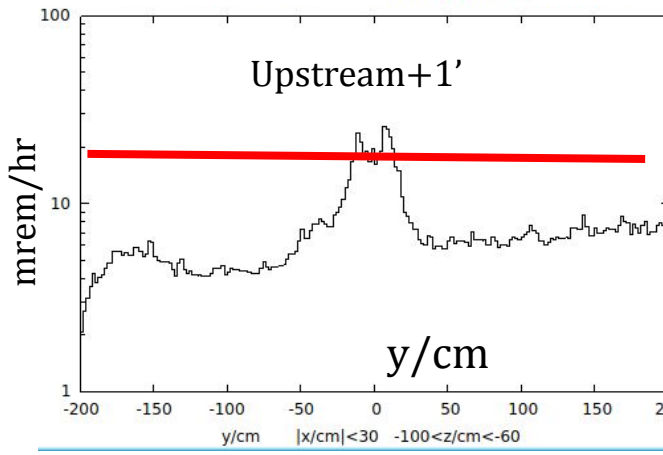
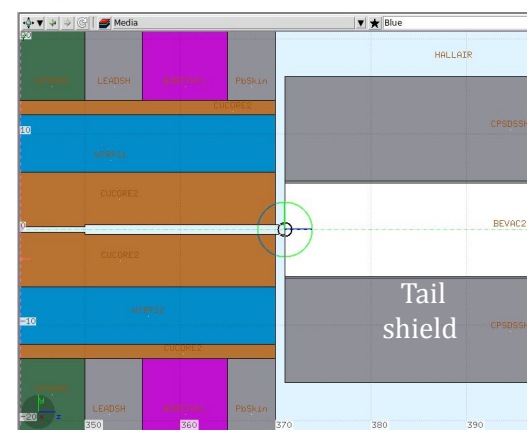
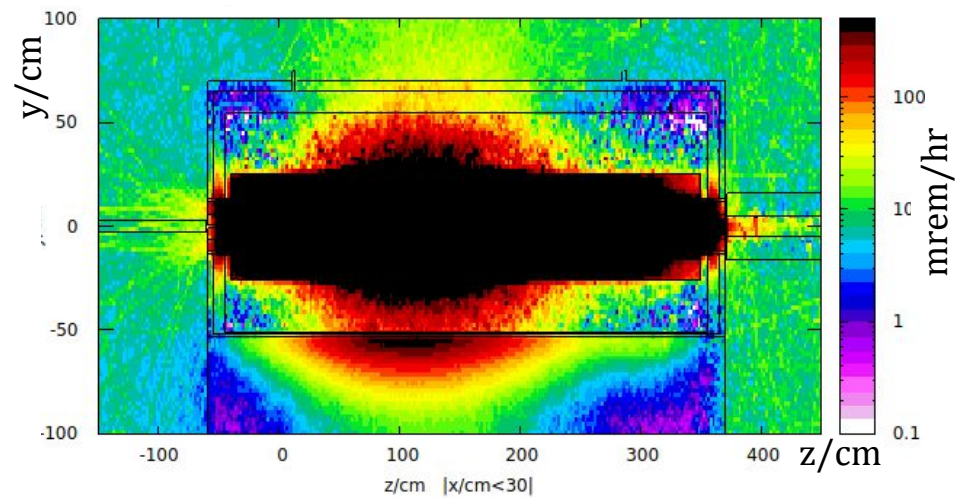

Prompt Dose Equivalent on top of Tagger hall and Beam Channel.

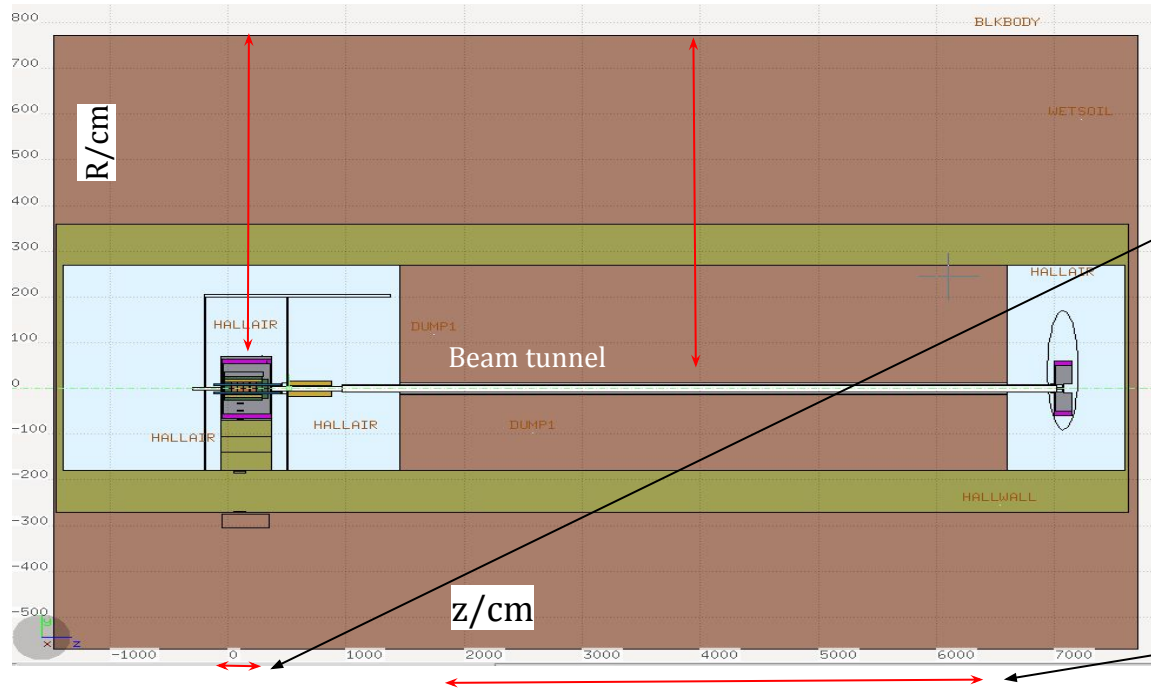

- Prompt DE is below **1 mrem/hr** at $R = \sim 2.5$ on top of Beam Tunnel.
- Prompt DE on top of hall mound $R=7.7$ m below **1 mrem/hr**.

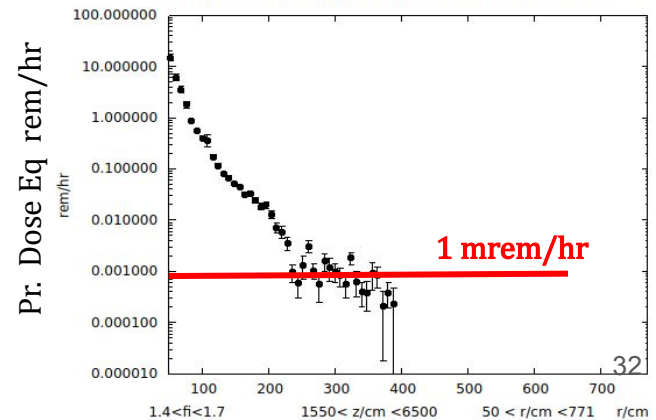
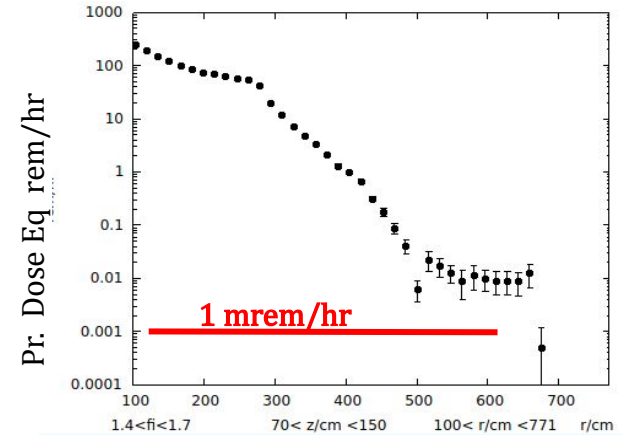

Prompt Dose Equivalent and Activation in KPT Alcove.

Prompt Dose Equivalent

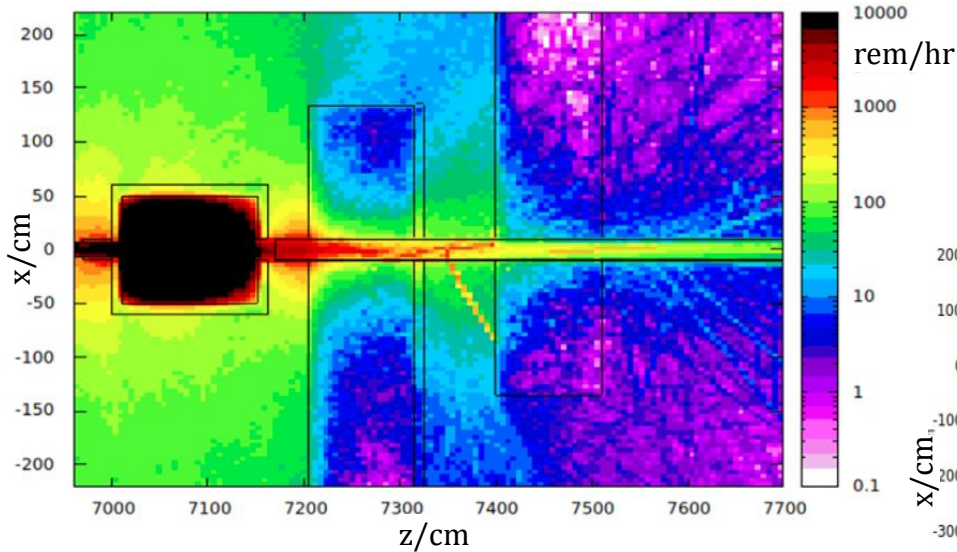

Activation: Dose Equivalent after 1000+1 hr

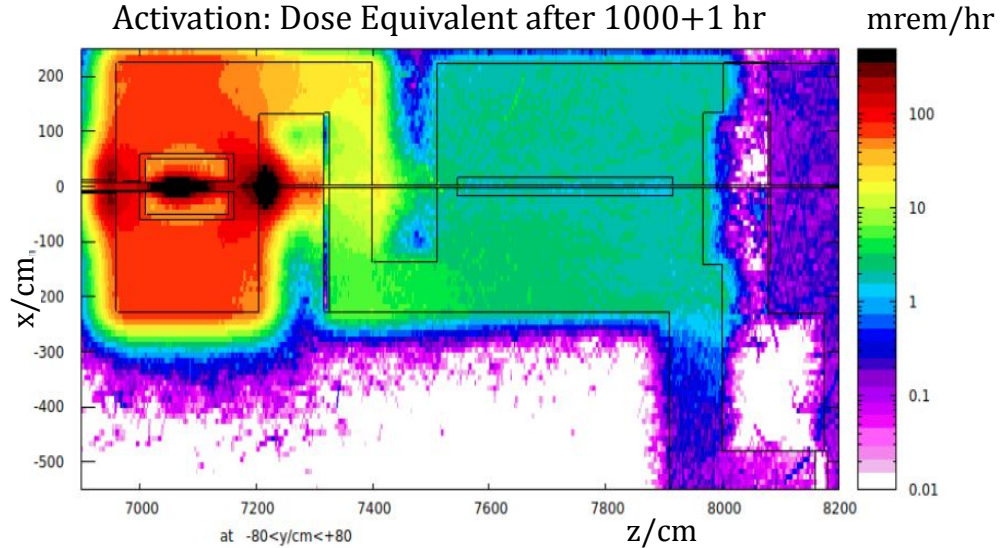

- Dose rates meet JLab radiation safety requirements.

Tritium activity in Soil and Cooling Water

Tritium detector in FLUKA model

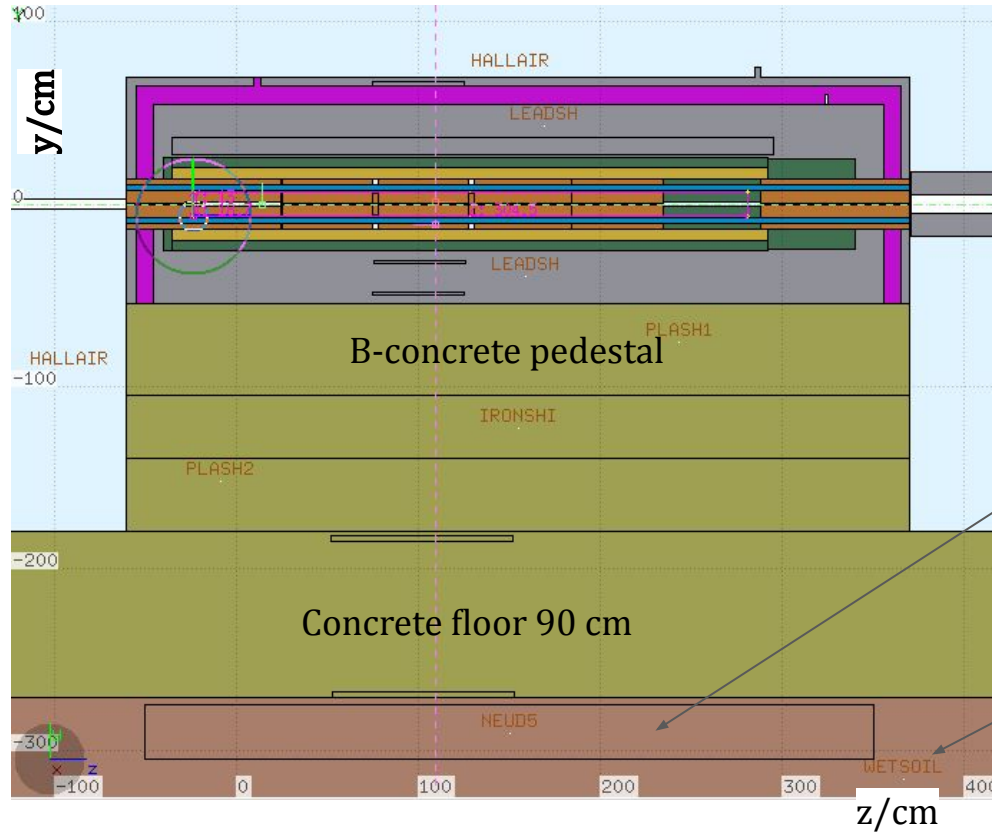

Tritium detector
 $V=2*0.3*4 \text{ m}^3=$
 2.4 m^3

Soil.
Wet sand with 20% of
water

Neutron fluence and Tritium in ground waters ($V=2.4 \text{ m}^3$).

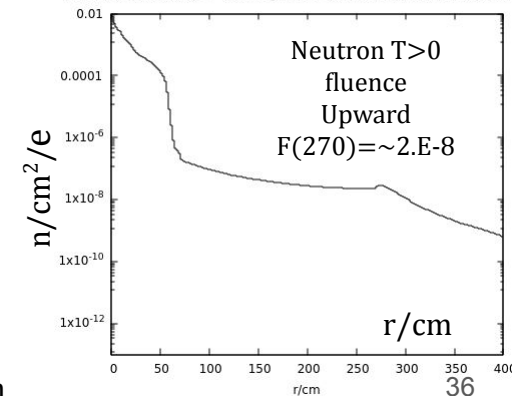
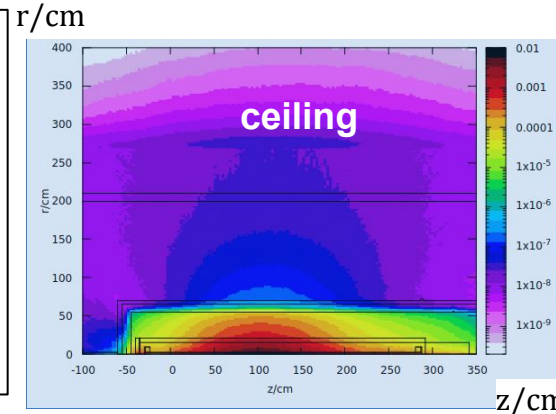
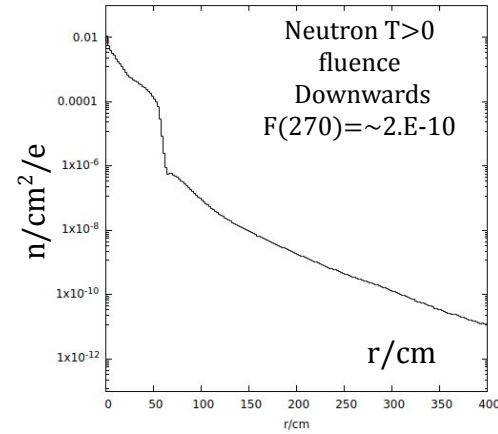
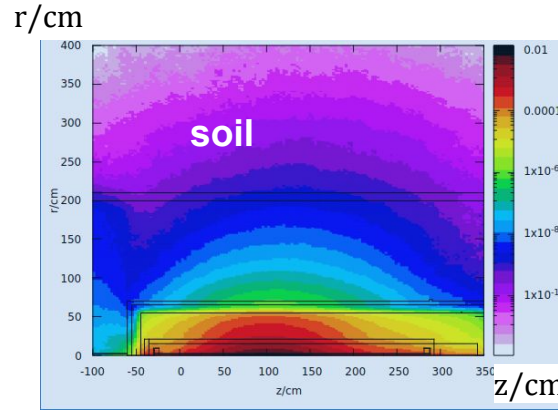
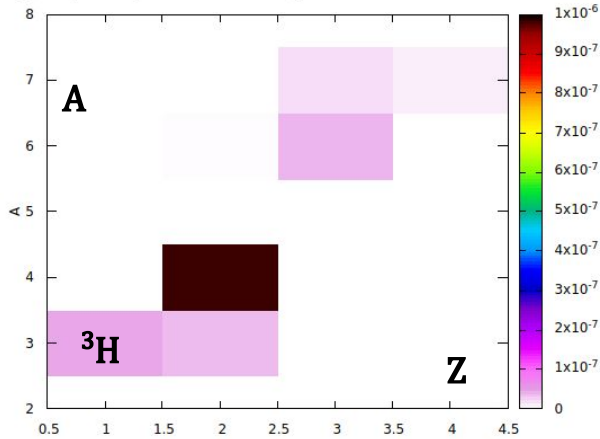

- ^3H yield in $V=2.4\text{E}+6 \text{ cm}^3 = 1.\text{E}-7 \text{ [T/e]}$.
 ^3H yield per year $N=1.\text{E}-7 \text{ [T/e]} 3.\text{E}+13 \text{ [e/s]} 3.14\text{E}+7 \text{ [s]} = 1.\text{E}+14$.
 Activity of soil volume after one year :=
 $-dN/dt = 1.\text{E}+14 / (12 * 3.14\text{E}+7 \text{ s}) = 2.6\text{E}+4 \text{ Bq}$
 Or $\sim 200 \text{ Bq/L}$ in water ($\sim 20\%$ by volume in soil).
- **Tritium activity in ground water is 3% of VA drink water limit 7000 Bq/L.**

Tritium in water of cooling pipes.

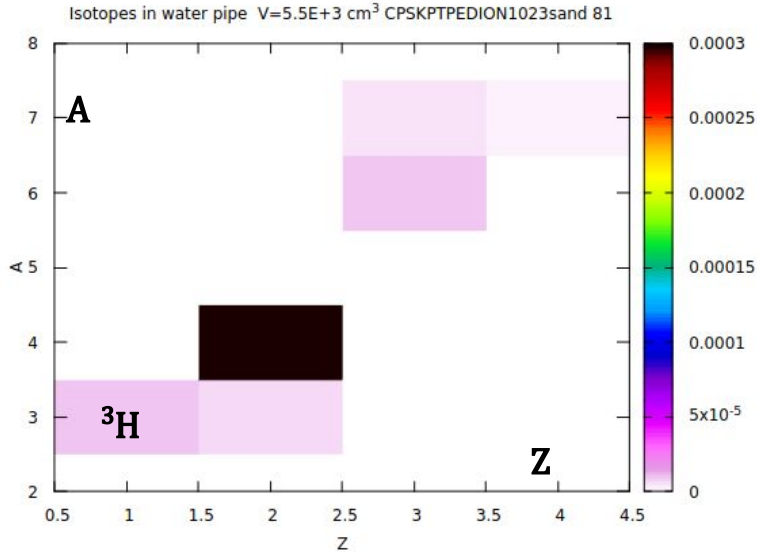

We read the yield of ³H in the cooling water: **1.E-5 [T/e]**

Number of T nuclei produced in one year: =

$$N_T = 1.E-5 \text{ [T/e]} \cdot 3.E+13 \text{ [e/s]} \cdot 3.14E+7 \text{ [s]} = 1.E+16 \text{ [T]}$$

Activity:

$$-dN_T/dt = 1.E+16 / (12 \cdot 3.14E+7 \text{ s}) = \mathbf{2.6 E+7 \text{ Bq}}$$

- This amount of Tritium may be accumulated by tritium absorbers.

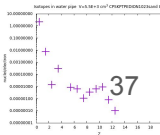

Lifetime of various materials from
FLUKA simulations.

Material lifetime from FLUKA simulations

CPS Material	“Lethal” Dose (unit)	Max. Dose rate (unit)	Life time (unit)	Life time (year)	Comment
SuperNG [16]	4×10^7 (rad)	10 (rad/h)	4×10^6 (h)	≥ 400	Connectors
EVA [12]	2×10^7 (rad)	10 (rad/h)	2×10^6 (h)	≥ 200	Cable insulation
Low Den. Polyeth. [12]	1×10^7 (rad)	10 (rad/h)	1×10^6 (h)	≥ 100	Cable insulation
Low Den. Polyeth. [12]	1×10^7 (rad)	5×10^3 (rad/h)	2×10^3 (h)	> 0.2	Shield
Alumina ceramics [14]	10^{21} (n/cm ²)	5×10^9 (n/cm ² /s)	2×10^{11} (s)	$\geq 6,000$	Coil ins.
Alum./Silica glass [13]	10^7 (Gy)	0.1 (Gy/s)	1×10^8 (s)	≥ 3	Opt. Prop. study
Silica ceramics [14]	$> 0.3 \times 10^{21}$ (n/cm ²)	5×10^9 (n/cm ² /s)	6×10^{10} (s)	$> 2,000$	3 m Coil insul.
Silica ceramics [12]	$> 10^8$ (Gy)	0.1 (Gy/s)	10^9 (s)	> 30	Coil insul.
Kapton [7]	10^7 (Gy)	0.1 (Gy/s)	10^8 (s)	≥ 3	Coil insulation
Fiber Glass Cloth [7]	5×10^7 (Gy)	0.1 (Gy/s)	5×10^8 (s)	≥ 15	Coil insulation
Epoxy [12]	6×10^7 (Gy)	0.1 (Gy/s)	6×10^8 (s)	≥ 20	Coil insul.

- Blowing He through CPS may prevent oxidation and improve lifetime of some materials.

Conclusion

In our concept, the **CPS** is an **Orientable Unit** containing the **entire Beam Channel**.

CPS is **surrounded** with several **layers of shielding** materials.

CPS provides a 98% **clear beam** of **2.E+13 photons/s** on KPT.

This concept allows **to avoid risks** and provide:

1. **No Overheating** of Copper Absorber ($T_{\max} = 210^{\circ} \text{C}$).
2. **No Short Circuit** in Magnet Coil for up to **15 years** with fiberglass based insulation.
3. **No Prompt Radiation** $> 10 \text{ rad/hr}$ around **CPS** and $> 0.1 \text{ mrem/hr}$ on top of Tagger Hall.
4. **No Activation** $> 20 \text{ mrem/hr}$ around **CPS** after 1000+1 hrs of continuous operation .
5. **No Tritium Activity** $> 200 \text{ Bq/L}$ in ground and cooling waters. ($\sim 3\%$ of VA limit).



Hall D K-Long Facility E12-19-001.

Experiment Readiness Review Phase I.

Jefferson Lab , 2023 Charge and Brief Answers.

- Is there any R&D needed to be done prior to start the construction of the KLong Facility? **No.**
- What is the status of the Compact Photon Source (CPS)? Specifically the
- 1. Conceptual design: Presented below.
- 2. **Approximations** in the MC simulations and Code used: Simplified Tagger & KPT Halls. FLUKA2021.2.9.
12 GeV beam $3.1E+13$ e/s, ($5\mu A$), FWHM=**2.5 mm**,
- 3. Evaluation of the **produced radiation**: **< 1 mrem/hr** on top of Tagger Hall and Tunnel Mounds.
- 4. Energy deposition , **Absorber** and **Lead temperature**: **<2 kW/cm³** , Cu Absorber **< 220°C** , **Pb shield < 110°C**.
- 5. Prompt **dose** and **activation** around the CPS (Tagger Hall): Dose **< 10 rad/hr** , **<20 mrem/hr**. Maps available.
- 6. **Magnet** and **insulation lifetime**: 0.25×0.5 Tm, $I \leq 1.8$ kA, wire 2×2 cm², **T<150°C**, **LT=15** years.
- 7. **Cooling system** & **ground waters contaminations**: Tritium Activity **2.6×10^7 Bq** & **200 Bq/L** after 1 year.
 - What will the photon **beam quality** be: **$\sim 2.E+13$ γ /s**, FWHM=4 cm, neutrons & \pm part**<2%** .
 - **Cost and schedule estimates** for the construction of the CPS: **\$800,000** without magnet.
 - **Civil constructions** to contain the radiation in the Tagger Hall: **No.**
 - **Decommissioning Plan** for CPS and Activated Components: To be mounted on rails to **move aside** for storage.

Optimized CPS with external layers of “elliptical” shape.

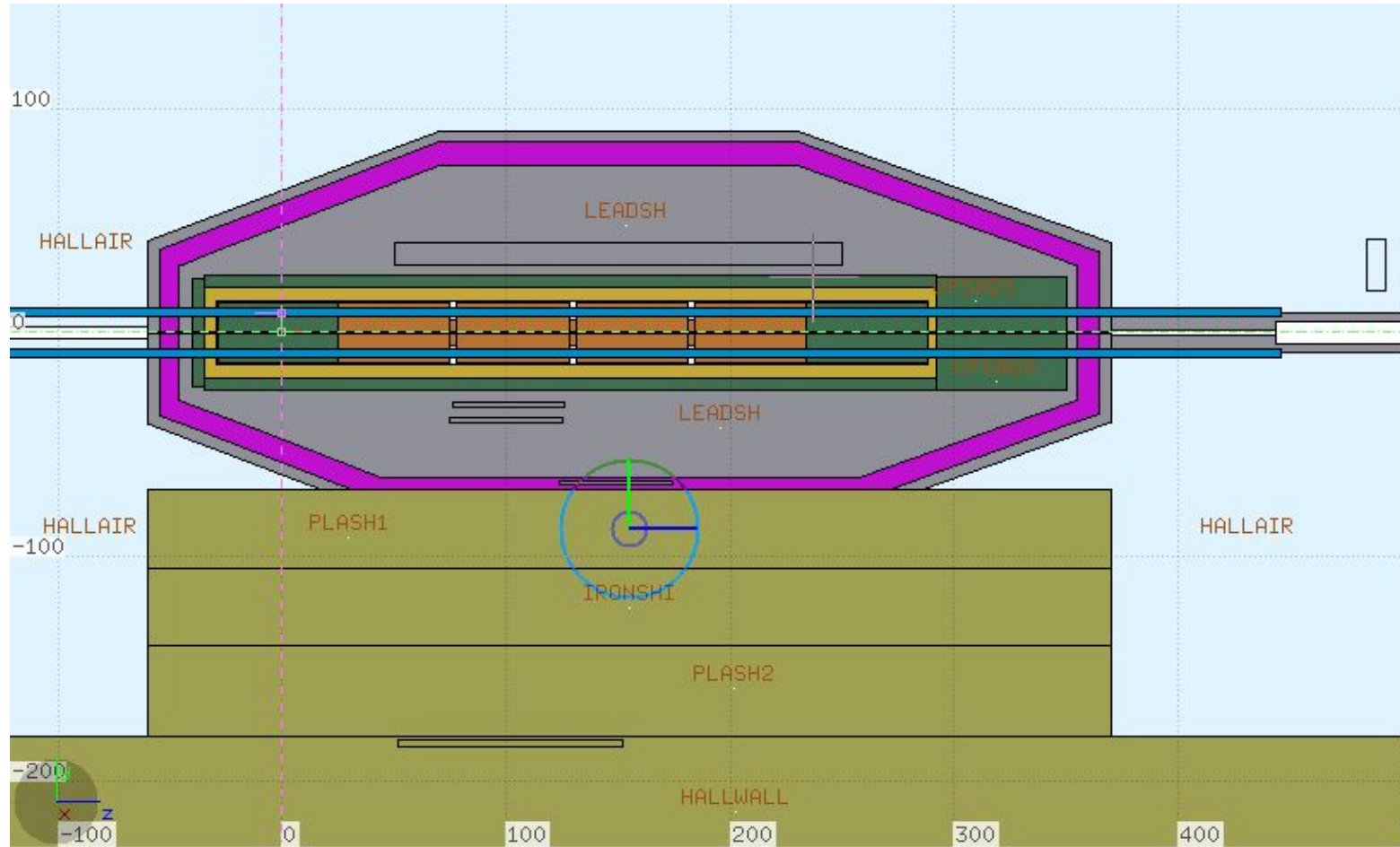

Thank you for your attention.

Hall D K-Long Facility E12-19-001. Experiment Readiness Review Phase I. Jefferson Lab , 2023 Charge.

- Is there any R&D needed to be done prior to start the construction of the KLong Facility? **No**
5 μ A electron beam on the CPS FWHM=**2.5 mm**, **3.1E+13 e/s**, steering magnet.
- What is the status of the Compact Photon Source (CPS)? Specifically the :
 1. Conceptual design: Presented.
 2. Evaluation of the **produced radiation**: < **1 mrem/hr** on top of Tagger Hall and Tunnel Mounds.
 3. **Approximations** in the MC simulations and Code used: Simplified Tagger & KPT Halls. FLUKA2021.2.9.
 4. Energy deposition , **Absorber** and **Lead temperature**: **2 kW/cm³** , Cu Absorber < **200°C** , **Pb shield < 100°C**.
 5. Prompt **dose** and **activation** around the CPS (Tagger Hall): Dose < **10** rad/hr , <**20** mrem/hr. Maps available.
 6. **Magnet** and **insulation lifetime**: 0.25 \times 0.5 Tm, I \leq 1.8 kA, 4-6 turns, wire 2 \times 2 cm², T<**150°C**, LT=**15** years.
 7. **Cooling system** and **ground water contaminations**: Tritium Activity **2.6*10⁷ Bq** and **200 Bq/L** after 1 year.
- What will the photon **beam quality** be: **1%** of neutrons and \pm part . FWHM=4 cm, **3E+13 s⁻¹**
- What are the **cost and schedule estimates** for the construction of the CPS: **800 k\$** (no magnet).
- Will **civil constructions** be needed to contain the radiation in the Tagger Hall: **No**
- What is **Decommissioning Plan** for CPS and Activated Components: mounted on a platform, **move aside**.

CPS Components. Weight and Cost.

CPS Component	Material	Density (g/cm ³)	Cost (\$/kg)	Weight (MetricT)	Total Cost (\$)
Absorb. In/Out	W	16.3	80.00	0.2	15,500
Lead skin	Pb	11.4	5.8	15.1	87,500
Plastic shield	Borated PE	1.2	20.5	0.5	10,100
Lead shield	Pb	11.4	5.8	36.5	211,400
Left shield	W	16.3	80.0	1.4	108,000
Top shield	W	16.3	80.0	0.8	67,000
Right shield	W	16.3	80.0	1.4	108,000
Bottom shield	W	16.3	80.0	0.8	67,000
Magnet	Fe	7.9	50.0	2.0	101,800
Absorber	Cu	9.0	122.6	0.2	27,400
Upstream shield	W/Cu	15.2	140.0	0.2	21,600
Downstream shield	W/Cu	15.2	140.0	1.2	171,400
CPS				60.9	894,100
Total tungsten				5.8	543,200

- CPS weight - 61,000 kg.
- CPS cost without magnet - \$793,000.
- Including Tungsten cost - \$543,000.

Coil Deformation due to Ampere's force.

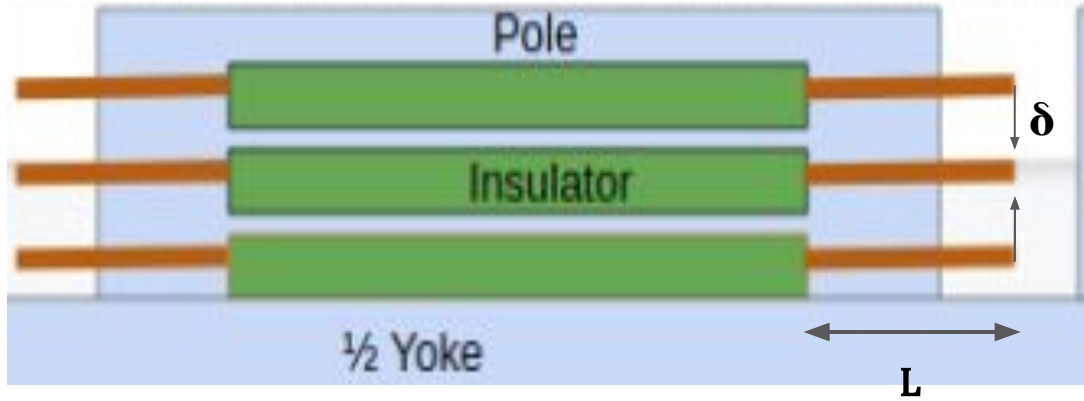

Ampere's force law:

$$f' = dF/dl = (\mu_0 / 2\pi) (I^2/d)$$

$$= 25 \text{ N/m}$$

at

$I = 1800 \text{ A}$ - current through wire

$d = 2.5 \text{ cm}$ - distance between wires

$$\mu_0 = 4\pi \times 10^{-7} \text{ N/A}^2$$

Consider a squared **Cu wire** $S = (1.7 \text{ cm})^2$, $L = 20 \text{ cm}$ as a rod with fixed end

under load including gravitation $+25.5 \text{ N/m}$, total $f = f' + 25.5 = 50.5 \text{ N/m}$.

From **tabulated formula** the maximum sag at the end of the rod:

$$\delta = 3/2 f (L/W)^4 E^{-1}$$

$$= 1.5 * (50/1.2) * (20/1.7)^4 * 10^{-11} = 12 \text{ microns (compare with 8 mm gap)}$$

where $E = 1.2 \times 10^{11} \text{ N/m}^2$ - Young's module **tabulated for copper**.

- **Insulation is not required for Coil return in high radiation area.**

Magnet at CPS exit cleans photon beam.

USRBIN CPSKPTLEAD1712narrGUNvacTRP 58

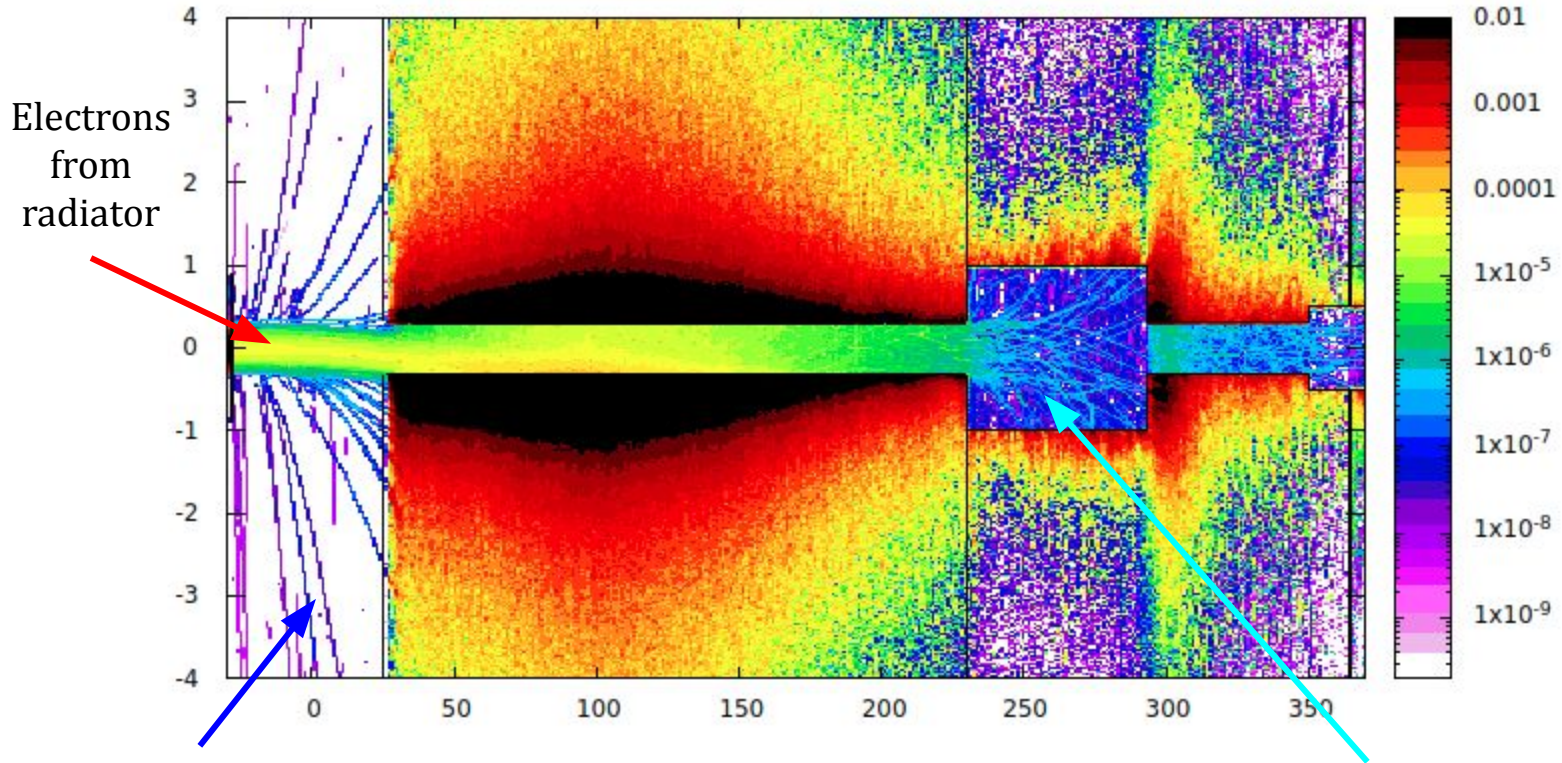

Power Deposition in Skinny Layer of Hot Segment . Fine map 0.05 cm.

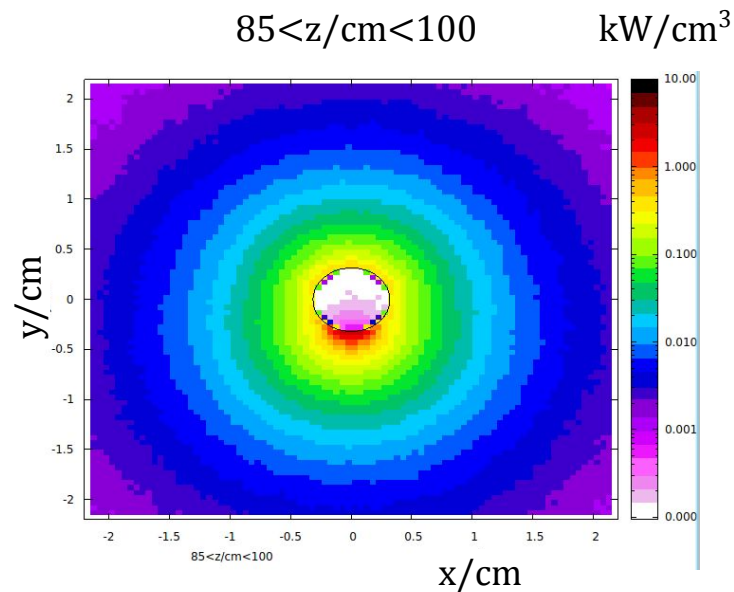
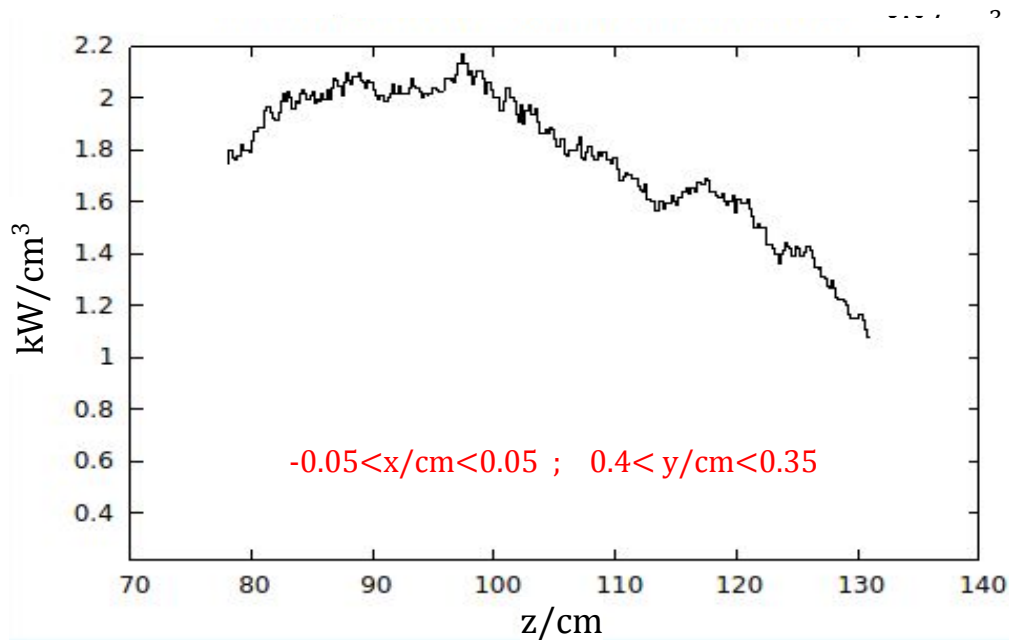

- Maximum $dP/dV = \sim 2 \text{ kW/cm}^3$
- **ANSYS calculations** are done by Tim Whitlatch (JLab) using this Map.

B: Steady-State Thermal

Temperature
Type: Temperature
Unit: °C
Time: 1 s
2/22/2023 2:28 PM

Calculation by Tim Whitlatch

Temperature field in the Hot Segment at Low Heat Transfer Coefficient, Fine mesh 2 mm.

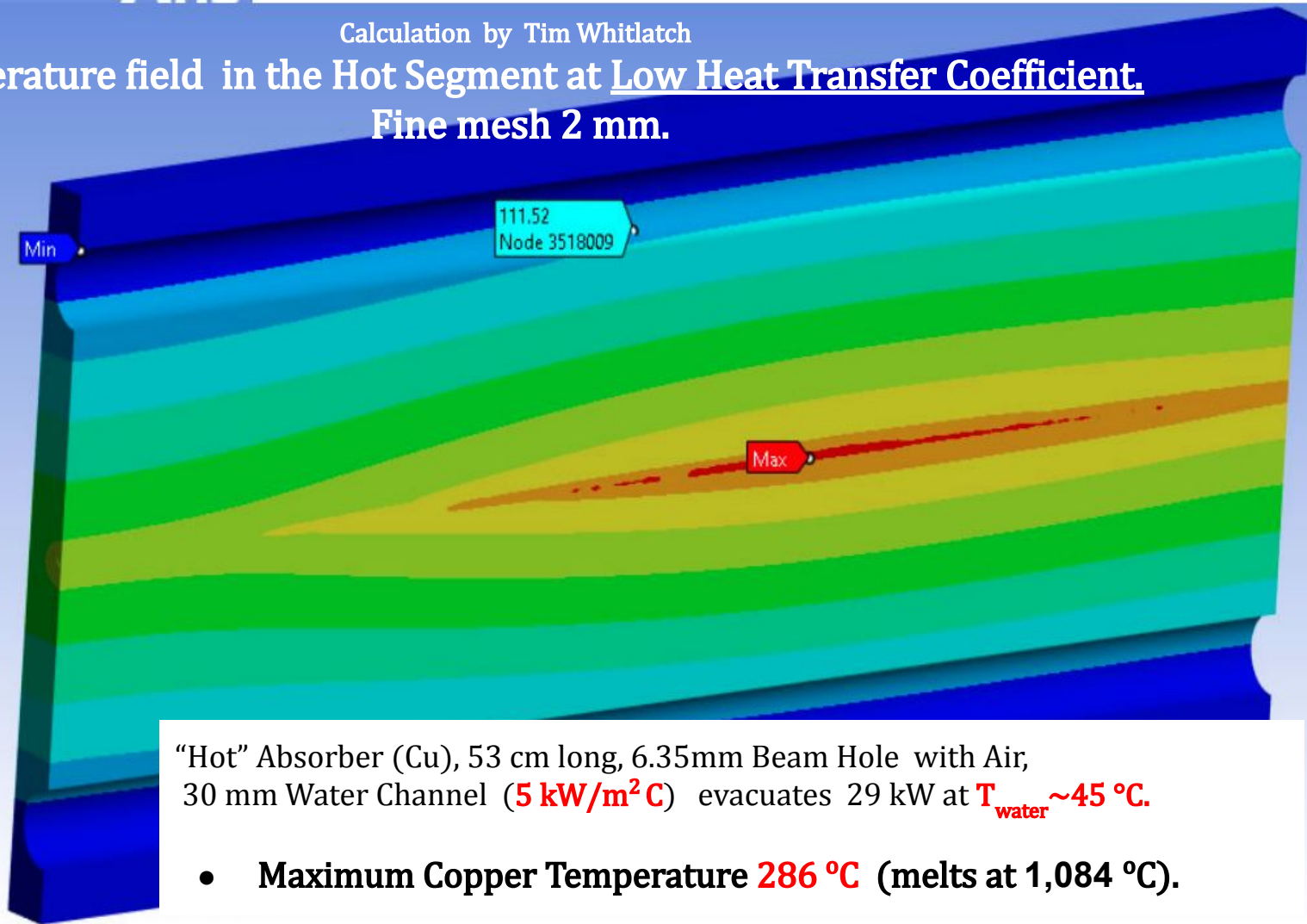
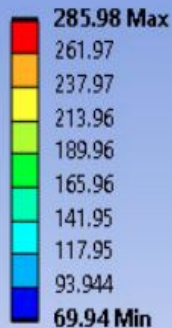

“Hot” Absorber (Cu), 53 cm long, 6.35mm Beam Hole with Air,
30 mm Water Channel ($5 \text{ kW/m}^2\text{C}$) evacuates 29 kW at $T_{\text{water}} \sim 45 \text{ }^\circ\text{C}$.

- **Maximum Copper Temperature $286 \text{ }^\circ\text{C}$ (melts at $1,084 \text{ }^\circ\text{C}$).**

Prompt dose and Polyethylene lifetime.

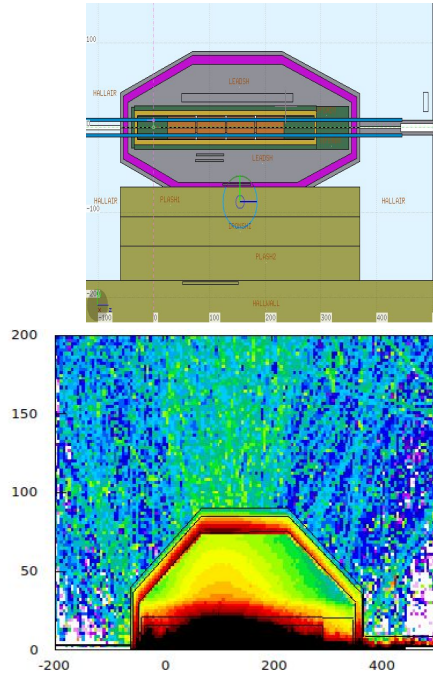

PE Tensile Strength vs Dose/kGy
1Gy=100 rd

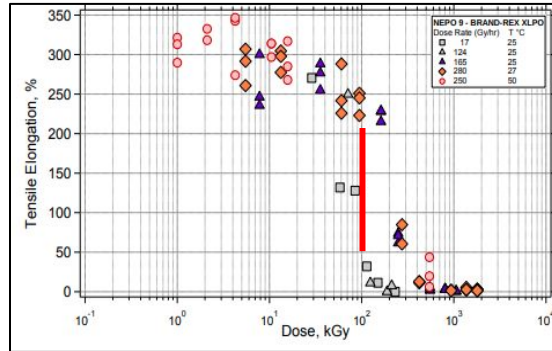

S.A. Waters, G.V. Wite , R. Tandon, L. Serna, M.Celina, R.Bernstine, "An Overview of Basic Radiation Effects on Polymers ", Sandia National Laboratories, U.S. DOE, SAND2013-8003P, 2013.

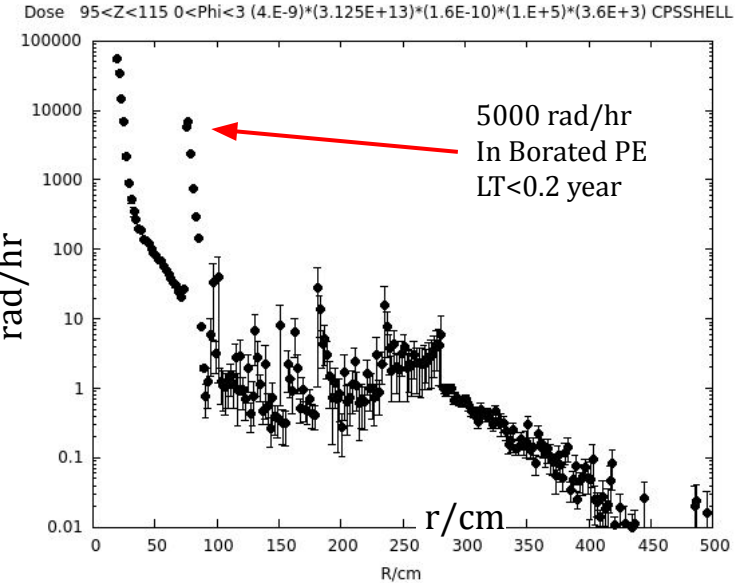

- BPE elastic properties degrade significantly after **1.E+7 rad** / 5000 rad/hr = **~0.2 year**.
- Borated polyethylene can **not** be used as **construction material**.
- Possible **solution**:- BPE granules in **metal tanks** or containers.

<https://www.osti.gov/biblio/4640611>

Neutron Flux r-profile in Hot Spot. Steel is OK up to 10^{22} n/cm²

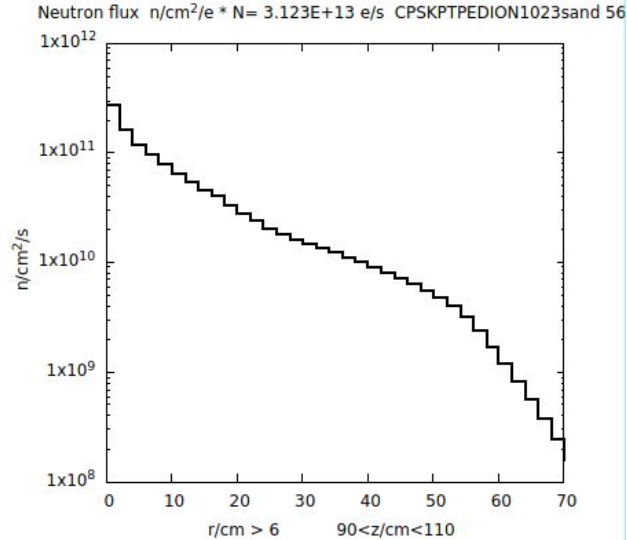

<https://www.osti.gov/biblio/4640611>

Life Time = 10^{11} s = 3200 years. Steel is OK up to 10^{22} n/cm².

Problem of High radiation in return part of Coils.

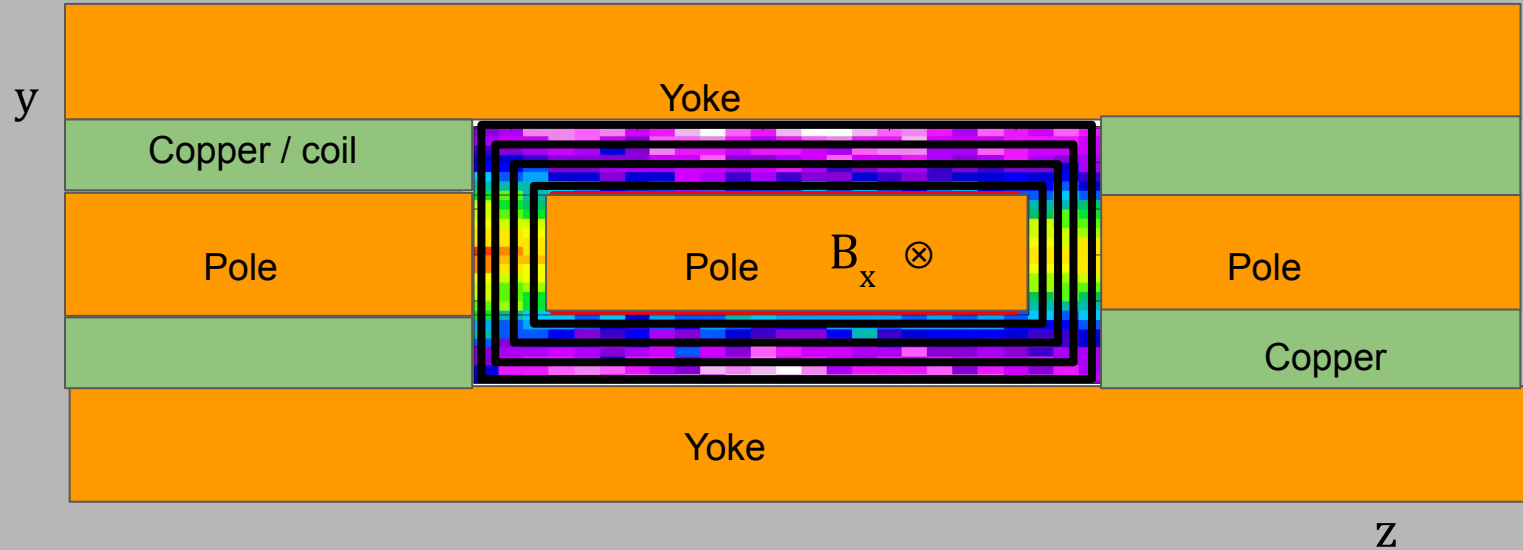

Coil Design and Insulation Exposure to Radiation.

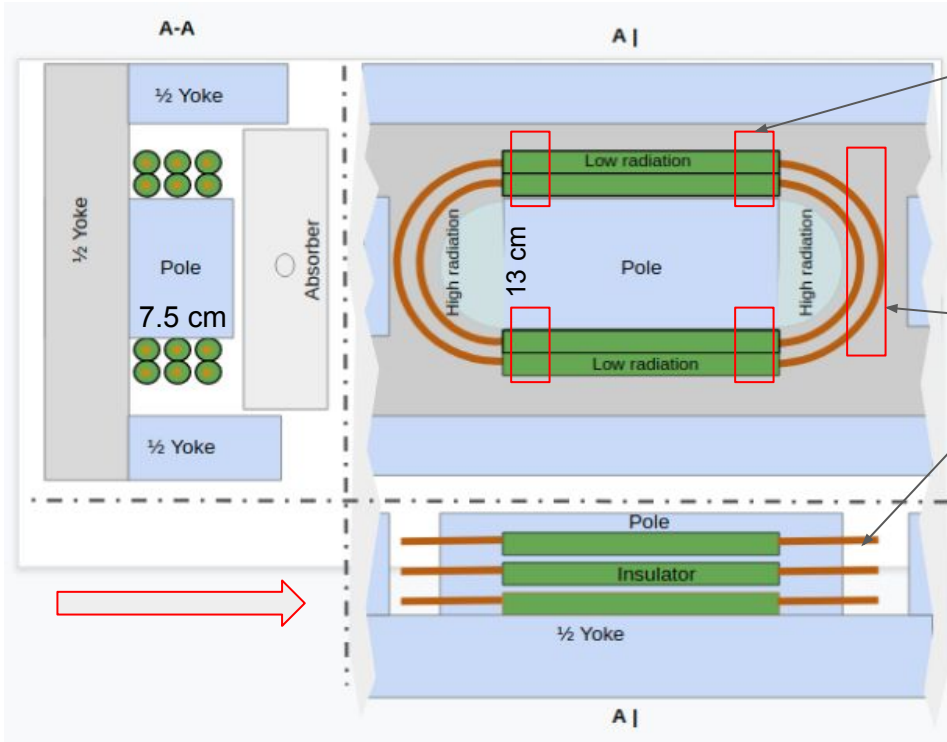

Hot area for insulation.

Very hot area,
Air insulation,
Gap between
wires
~8 mm.

Ampere's force law:

$$dF/dl = (\mu_0 / 2\pi) (I^2/d) = \sim 25 \text{ N/m}$$

at $I=1800 \text{ A}$; $d=2.5 \text{ cm}$; $\mu_0 = 4\pi \times 10^{-7} \text{ N/A}^2$

- Attractive force of bent parts $F = 25 \text{ N/m} \times 0.3 \text{ m} = 7.5 \text{ N}$.
- Copper 1.7 cm -wires (tubes) will not touch .

Leakage Current between wires.

Current through gas :

$$dI/ds \text{ [A/cm}^2\text{]} = n \text{ [e/cm}^3\text{]} \times v \text{ [cm/s]} \times e \text{ [C]}$$

1. What is concentration of electrons n ?
2. What is the drift velocity of electrons v ?

1. What is n and Ionisation in Magnet Coil.

$$dI/ds [A/cm^2] = n [e/cm^3] \times v [cm/s] \times e$$

Assume **maximum dose D in space between coil windings** is $D = 1.E-5 [GeV/g/e]$ ($\sim 10 \times$ of **FLUKA** estimate).

Assume **10 eV** is required to produce one electron-ion pair.

Dose D translate to ion **pair production** $\sim 1.E+3 [pair/g/e] = 1.E-5 [GeV/g/e] / 1.E-8 [GeV]$.

Ion pair production rate **per unit of mass** is at beam intensity $3.E+13 [e/s]$:

$$dN/dt = 3.E+16 [pair/g/s] = 1.E+3 [pairs/g/e] \times 3.E+13 [e/s].$$

Assume we have **1 cm of argon** between windings ($\rho_A = 1.7E-3 [g\ cm^{-3}] = \sim 2.E-3$).

Air - $1.3E-3$; He - $0.17E-3$

So we find the ion **production rate between coil wires** :

$$dn_p/dt = (dN/dt) \rho_A = 3.E+16 [pairs\ g^{-1}\ s^{-1}] \times 2.E-3 [g\ cm^{-3}] = 6.E+13 [pair\ cm^{-3}\ s^{-1}]$$

This rate is **balanced by recombination** of argon ions and electrons.

1. What is n. Ionisation in Magnet Coil and Leakage Current.

$$dI/ds \text{ [A/cm}^2\text{]} = n \text{ [e/cm}^3\text{]} \times v \text{ [cm/s]} \times e$$

$dn_p/dt = 6.E+13 \text{ [pairs cm}^{-3} \text{ s}^{-1}\text{]}$ is balanced by recombination of argon ions and electrons defined as:

$$dn_r/dt = \alpha n_+ n_- , \quad \text{where } \alpha = 2.E-10 \text{ [cm}^3 \text{ i}^{-1} \text{ s}^{-1}\text{]} \text{ recombination coeff. for Argon.}$$

$$(\alpha = \sim 1.E-8 \text{ [cm}^3 \text{ i}^{-1} \text{ s}^{-1}\text{]} \text{ for He, and } \alpha = 1.E-6 \text{ — } 1.e-7 \text{ for Air.)}$$

Assuming equal densities $n_+ = n_- = n$ for the equilibrium density of electrons n we write:

$$\alpha n^2 = dn_p/dt = 6.E+13 \text{ [pairs cm}^{-3} \text{ s}^{-1}\text{]} \text{ from the previous slide and}$$

$$n^2 = \alpha^{-1} dn_i/dt = 0.5E+10 \text{ [pairs s cm}^{-3}\text{]} \times 6.E+13 \text{ [pairs cm}^{-3} \text{ s}^{-1}\text{]} = 3.E+23 \text{ (pairs/cm}^3\text{)}^2.$$

- The equilibrium density of electrons yields $n = 6.E+11 \text{ (pairs/cm}^3\text{)}.$
- Density of electrons is proportional to the gas specific factor $(\alpha^{-1} q_A)^{1/2}.$

2. What is v and Electric Field between Wires at 2 kA current.

What is Voltage between windings?

Copper resistivity $\kappa=1.7E-6$ [Ohm·cm]; $L_w/S_w = 100 \text{ cm}/3 \text{ cm}^2 = 25 \text{ cm}^{-1}$

=> **Voltage between windings** ($V = I \times R_w$ where $R_w = \kappa \times L_w/S_w$)

$V = 2000 \text{ [A]} \times 1.7E-6 \text{ [Ohm·cm]} \times 25 \text{ [cm}^{-1}] = 2.E-6 \times 5.E+4 \text{ [Ohm·A]}$

$$V = 0.1 \text{ V.}$$

From **Top Plot** ⁽¹⁾ we see **drift velocity** as $v = v(E/P)$ where

E -electric field, P=gas pressure.

In our case $E=0.1 \text{ [V cm}^{-1}]$; $P \sim 1000 \text{ [mmHg]}$ =>

$$E/P = 1.E-4 \text{ [V cm}^{-1}/\text{mmHg]}$$

From Top Plot we read $v(0.1) = 2.E+6 \text{ [cm/s]}$ and linear interpolation yields:

$$v(1.E-4) = 2.E+3 \text{ [cm/s].}$$

From Bottom Plot for air we find $v(1.E-4) = 5.E+1 \text{ cm/s.}$

- (1) F. Sauli, "PRINCIPLES OF OPERATION OF MULTIWIRED PROPORTIONAL AND DRIFT CHAMBERS",

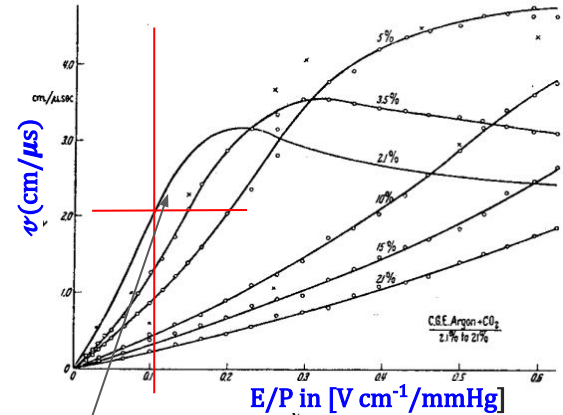

Fig. 29 Drift velocity of electrons in several argon-carbon dioxide mixtures⁽¹²⁾

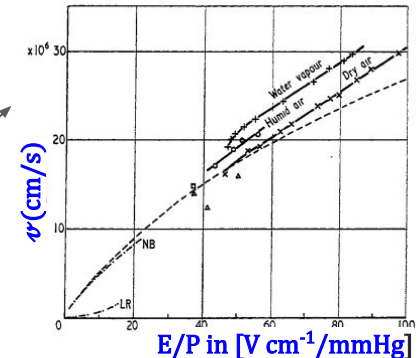

Figure 5. Electron drift velocity in dry air, humid air and water vapour as a function of reduced electrical field. Pressure readings reduced to temperature of 20 °C; humid air, $p_w/p = 16\%$. Broken line, Townsend and Tizard 1913; Δ , Raether; \square , Rieman 1944; \circ , Nielsen and Bradbury 1937; \times , Lowe and Rees 1963.

2. What is leakage current between wires .

Current density between windings:

$$dI/ds \text{ [A/cm}^2\text{]} = n \text{ [e/cm}^3\text{]} \times v \text{ [cm/s]} \times 1.6\text{E-19 [C/e]} \propto v (\alpha^{-1} \rho_A)^{1/2}$$

Where $n=6.\text{E+11 [e/cm}^3\text{]}$.

$v=2.\text{E+3 [cm/s]}$.

For the current density we find :

$$\begin{aligned} dI/ds \text{ [A/cm}^2\text{]} &= 6.\text{E+11[e/cm}^3\text{]} \times 2.\text{E+3 [cm/s]} \times 1.6\text{E-19 [C/e]} = 12 \times 1.6 \text{ E}(+11+3-19) = \\ &= 20.\text{E-5 [A/cm}^2\text{]}. \end{aligned}$$

Wire area $S=2 \text{ cm} \times 100 \text{ cm} = 2.\text{E+2 cm}^2$, and the maximum possible current yields:

$$I \text{ [A]} = 20.\text{E-5 [A/cm}^2\text{]} \times 2.\text{E+2 [cm}^2\text{]} = 40.\text{E-3 [A]} = 40 \text{ [mA]}. \text{ Compare to 2 kA !}$$

- Leakage is of 2.E-5 of the wire current. It does not affect the coil performance.
- For Helium the leakage is ~ 10 times lower - due to the gas specific factor $v (\alpha^{-1} \rho_{\text{He}})^{1/2}$.

(1)

