

Strange Hadron Spectroscopy with Secondary KL Beam in Hall-D

Moskov Amaryan

*Old Dominion University
Norfolk, VA*

(on behalf of  *Collaboration)*

PAC47, JLab, July 30, 2019

K-long Facility Collaboration

is formed through open opt-in procedure

From GlueX White Paper on Future Hall-D Physics:

There are many unresolved issues in hadron physics and the vast opportunities and advances that only become possible with KL facility. This KL facility would revolutionize our understanding of bound systems containing strange quarks, providing the long sought, high quality experimental data to reach deeper into strange quark sector. This will enable the tremendous recent progress in spectroscopy in both theory and experiment with electromagnetic beams to continue into a new frontier.

Proposal for JLab PAC47

Strange Hadron Spectroscopy with Secondary K_L Beam in Hall DExperimental Support:

S. Adhikari³⁵, M. J. Amaryan (**Contact Person, Spokesperson**)³⁵, A. Austregesilo³⁹, M. Baalouch⁴², M. Bashkanov (**Spokesperson**)⁵⁷, V. Baturin³⁵, V. V. Berdnikov^{52,32}, T. Black⁵⁵, W. Boeglin³⁰, W. J. Briscoe⁵³, V. D. Burkert³³, E. Chudakov³³, P. L. Cole³, O. Cortes-Becerra⁵³, V. Crede⁴⁵, D. Day¹², P. Degtyarenko³³, S. Dobbs (**Spokesperson**)⁴⁵, G. Dodge³⁵, A. G. Dolgolenko³¹, H. Egiyan³³, P. Eugenio⁴⁵, S. Fegan⁵¹, A. Filippi⁴⁹, S. Furletov³³, L. Gan⁵⁵, A. Gasparyan²⁰, G. Gavalian³³, D. I. Glazier¹⁹, V. S. Goryachev³¹, L. Guo³⁰, A. Hayrapetyan¹⁸, G. M. Huber⁵⁰, A. Hurley⁵⁴, C. E. Hyde³⁵, I. Illari⁵¹, D. G. Ireland¹⁹, K. Joo⁴⁴, V. Kakoyan⁵⁶, G. Kalicy⁵², M. Kamel³⁰, C. D. Keith³³, C. W. Kim⁵¹, G. Krafft³³, S. Kuhn³⁵, S. Kuleshov⁴³, A. B. Laptev²⁸, I. Larin¹, D. Lawrence³³, D. I. Lersch⁴⁵, W. Li⁵⁴, V. E. Lyubovitskij^{49,46,47,51}, D. Mack³³, D. M. Manley²⁷, H. Marukyan⁵⁶, V. Matveev³¹, M. McCaughan³³, B. McKinnon¹⁹, C. A. Meyer³⁹, F. Nerling^{16,14}, G. Niculescu²², A. Ostrovidov⁴⁵, Z. Papandreou⁴⁰, K. Park³³, E. Pasyuk³³, L. Pentchev³³, W. Phelps⁵³, J. W. Price¹¹, J. Reinhold³⁰, J. Ritman (**Spokesperson**)^{7,25}, D. Romanov³², C. Salgado³⁴, T. Satogata³³, A. M. Schertz⁵⁴, S. Schadmand²⁵, D. I. Sober⁵², A. Somov³³, S. Somov³², J. R. Stevens (**Spokesperson**)⁵⁴, I. I. Strakovsky (**Spokesperson**)⁵³, V. Tarasov³¹, S. Taylor³³, A. Thiel¹⁹, D. Watts⁵⁷, L. Weinstein³⁵, D. Werthmüller⁵⁷, T. Whitlatch³³, N. Wickramaarachchi³⁵, B. Wojtsekhowski³³, N. Zachariou⁵⁷, J. Zhang¹²

Theoretical Support:

A. V. Anisovich^{8,15}, A. Bazavov¹³, R. Bellwied²⁴, V. Bernard³⁸, G. Colangelo⁴, A. Cieply⁴¹, M. Döring⁵³, S. Eidelman^{36,37}, A. Eskandarian⁵³, J. Goity^{33,21}, H. Haberzettl⁵³, M. Hadžimehmedović⁵⁰, R. L. Jaffe¹⁰, B. Z. Kopeliovich⁵¹, H. Leutwyler⁴, M. Mai⁵³, V. Mathieu²⁹, M. Matveev¹⁵, U.-G. Meißner^{8,26}, V. Mokeev³³, C. Morningstar³⁹, B. Moussallam³⁸, K. Nakayama², V. Nikonov^{8,15}, Y. Oh⁵⁹, R. Omerović⁵⁰, H. Osmanović⁵⁰, J. R. Pelaez²⁹, A. Pilloni³³, D. Richards³³, D.-O. Riska²³, A. Rodas²⁹, J. Ruiz de Elvira⁴, H.-Y. Ryu⁹, E. Santopinto¹⁷, A. V. Sarantsev^{8,15}, J. Stahov⁵⁰, A. Švarc⁵⁸, A. Szczepaniak^{6,33}, R. L. Workman⁵⁰, B. Zou⁵,

¹ University of Massachusetts, Amherst, MA 01003, USA

² University of Georgia (UGA), Athens, GA 30602, USA

³ Lamar University, Beaumont, TX 77710, USA

⁴ University of Bern, CH-3012 Bern, Switzerland

Outline

Current Status

- *Hyperon Spectroscopy*
- *Strange Meson Spectroscopy*
- *Thermodynamics of Early Universe*

Future Prospects with K_L Facility at JLab

- *Electron Beam*
- *Compact Photon Source*
- *Be Target*
- *Flux Monitor*
- *K_L Beam*
- *LH_2/LD_2 Target*

Summary

Measurements on Proton Target

existing data

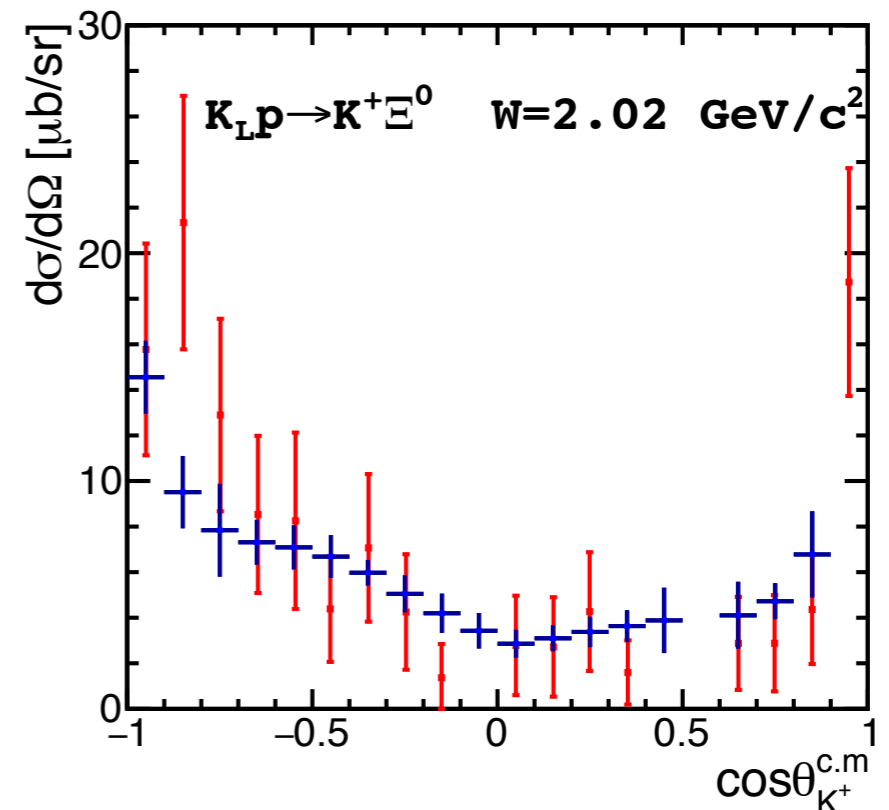
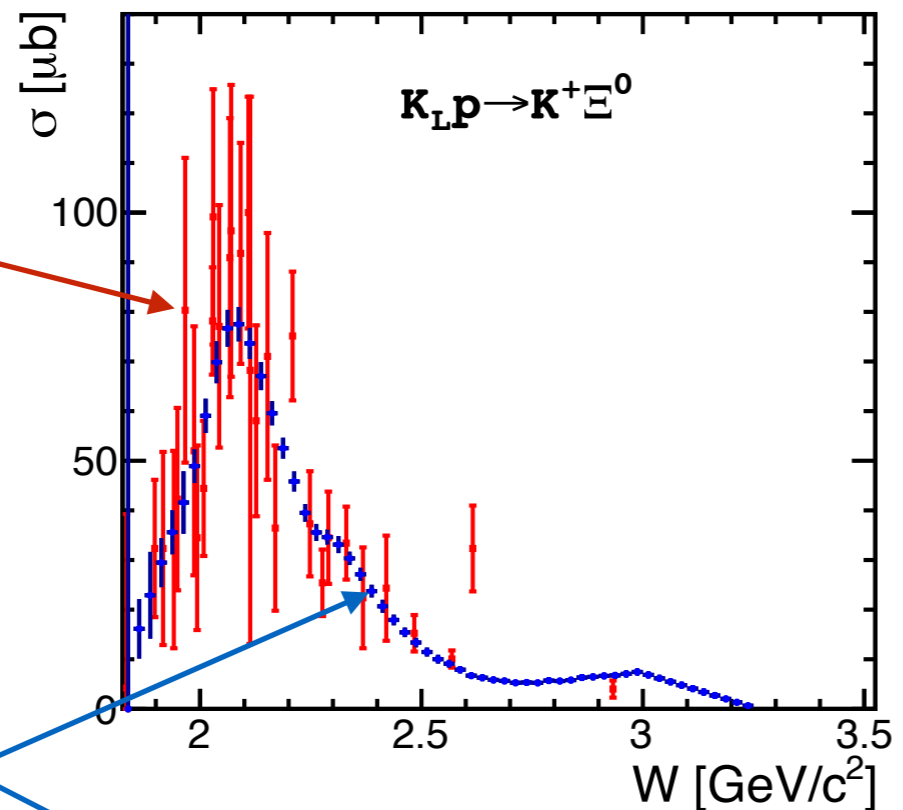

KLF 100 days

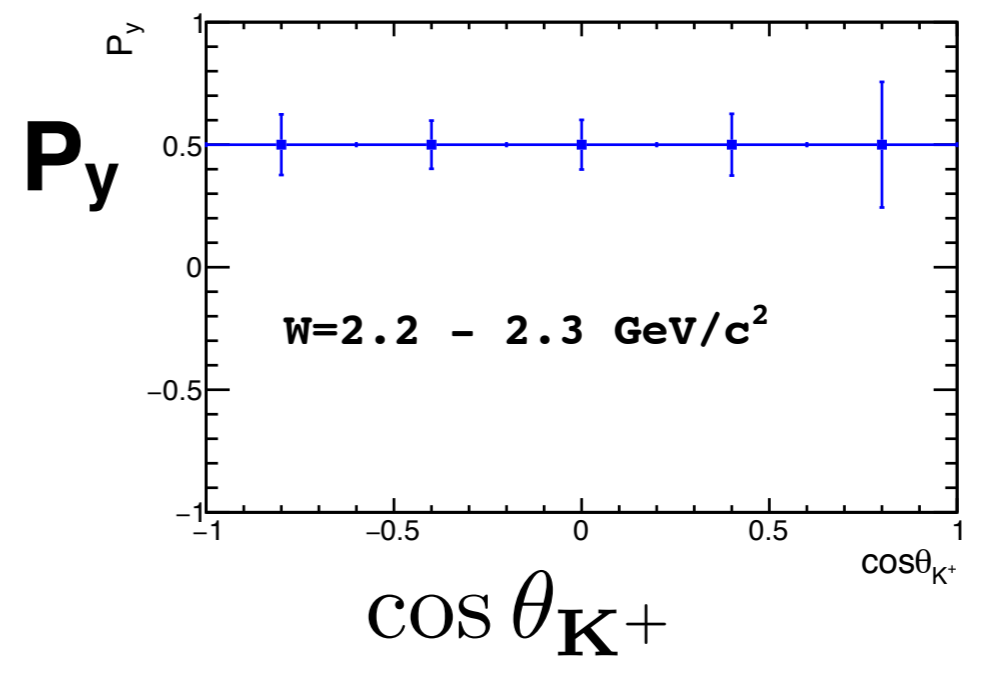
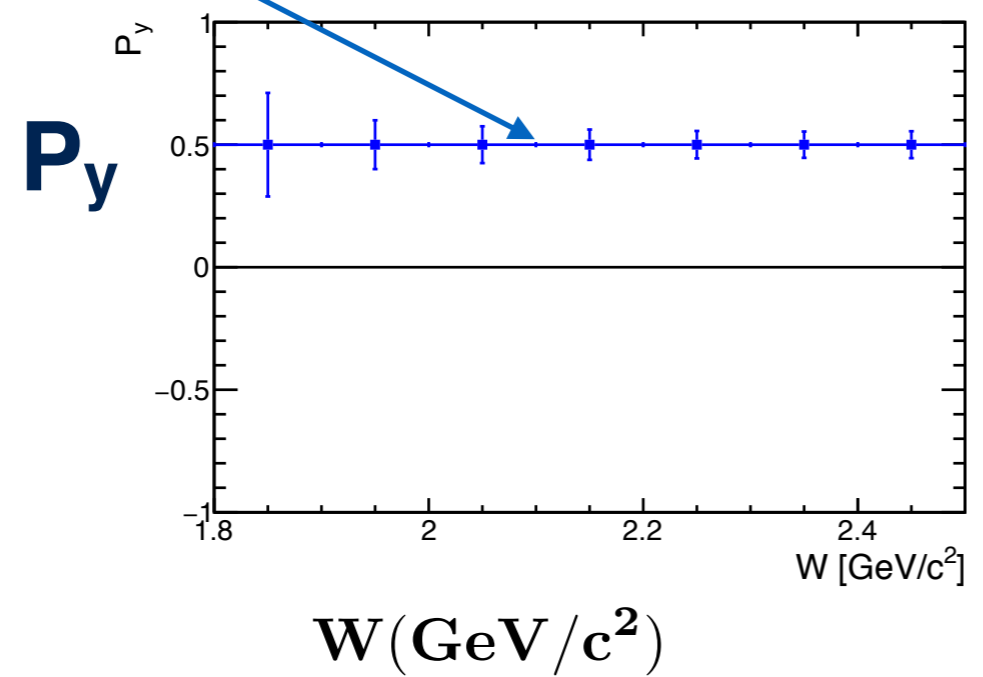

Hyperon Spectroscopy

According to *LQCD* there should be many more states including hybrids (thick bordered)

8-states

5-states

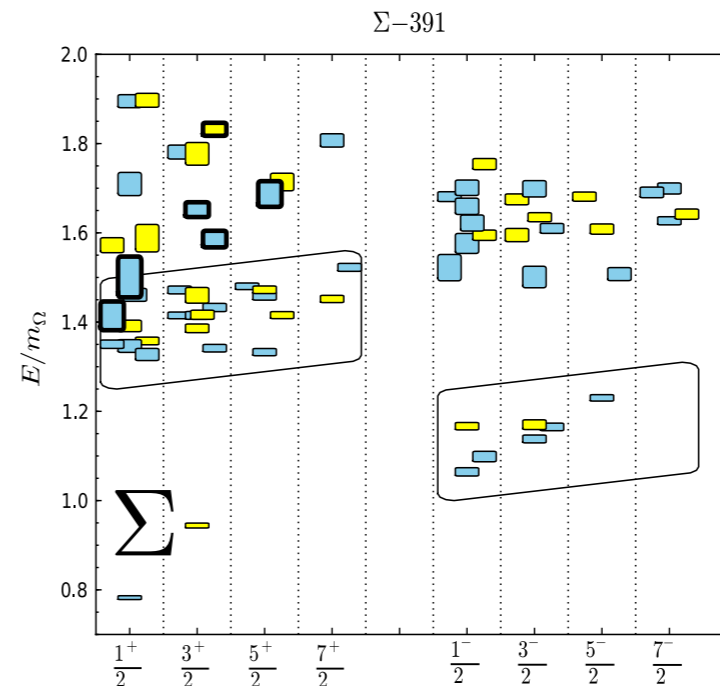
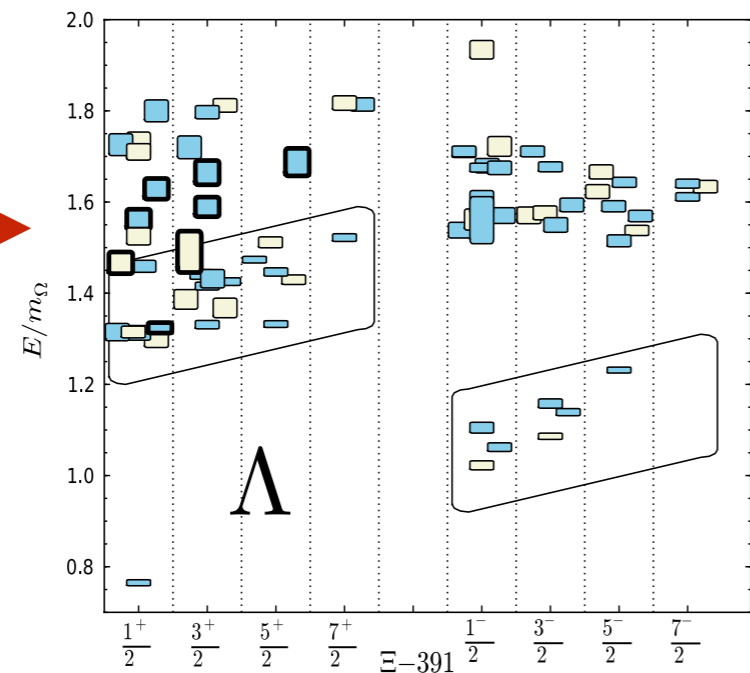

6-states

4-states

3-states

4-states

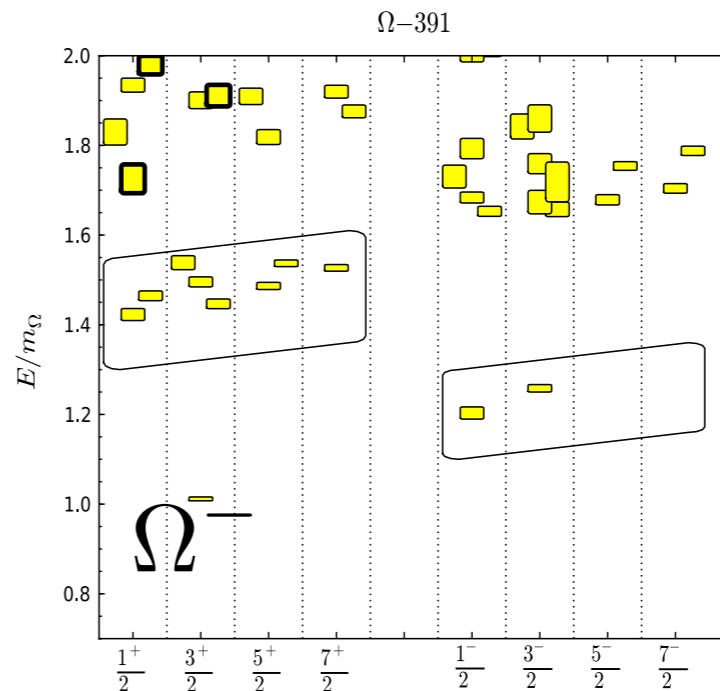
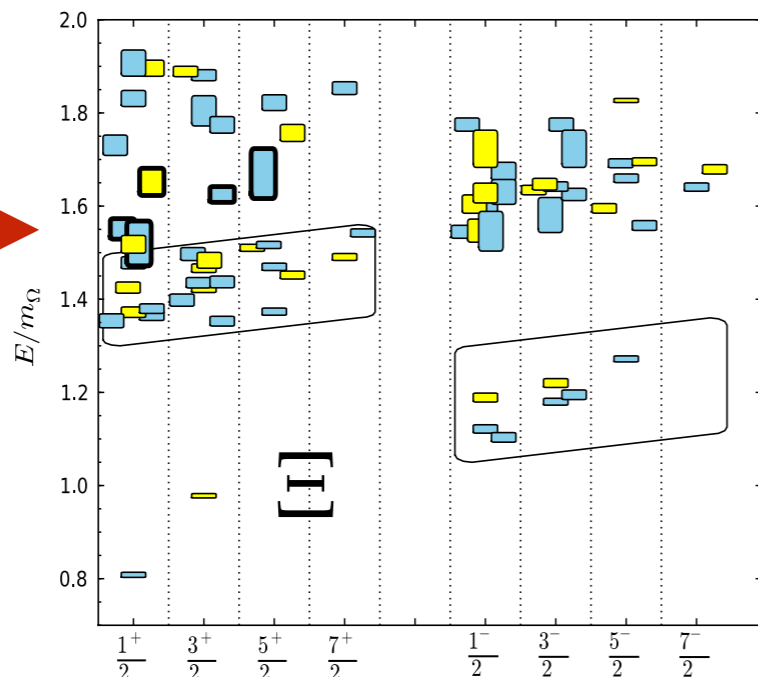

1-state

1-state

Search for Hyperon Resonances with PWA

For Scattering experiments on both proton & neutron targets one needs to determine:

- differential cross sections**
- self polarization of strange hyperons**
- perform coupled-channel PWA**
- look for poles in complex energy plane
(contrary to naïve bump hunting)**
- identify all Λ^* , Σ^* , Ξ^* & Ω^* up to 2400 MeV**

**we use KN scattering data with statistics
generated according to expected K-long Facility (KLF)
data for 20 and 100 days to show PWA sensitivity
to obtain results close to the best fit**

Bonn-Gatchina PWA

Total Cross Section

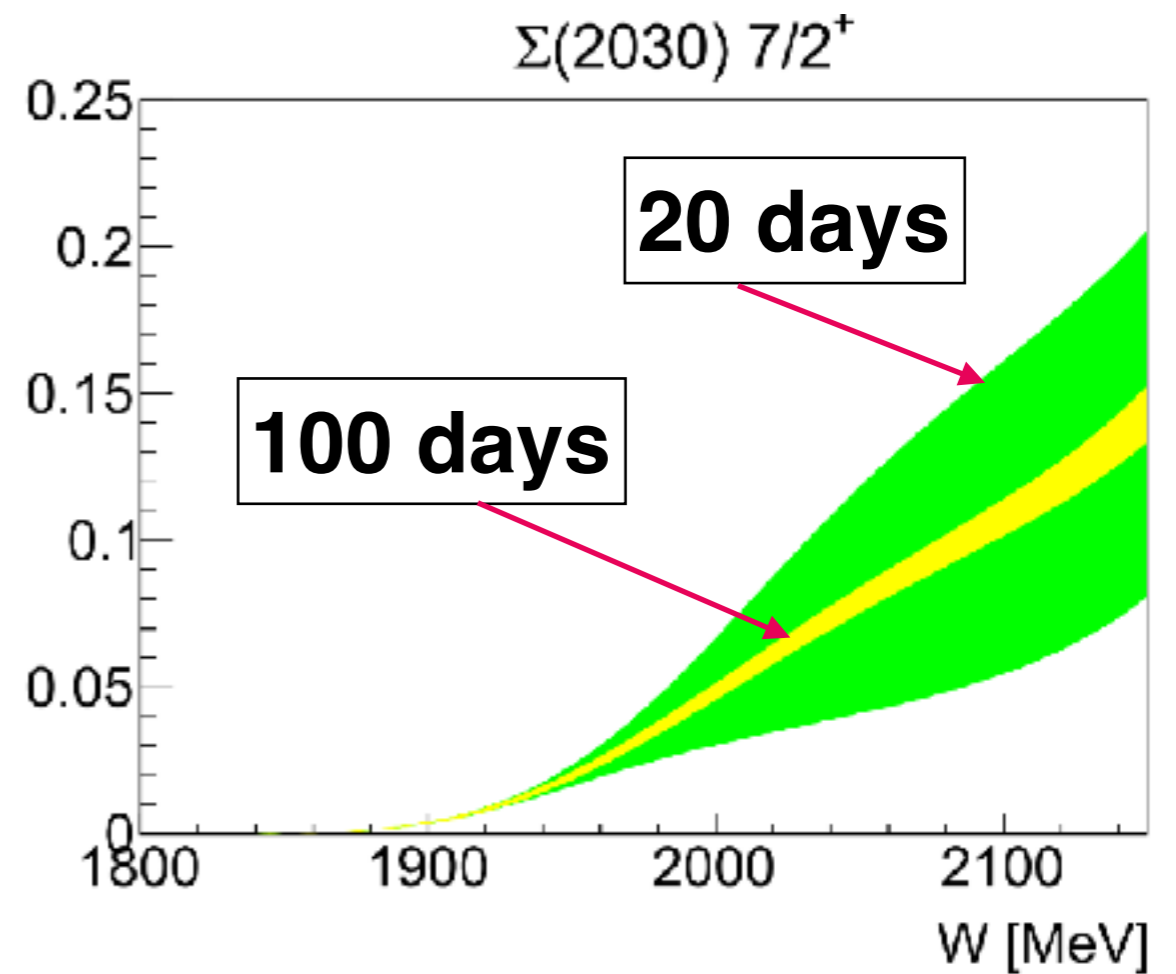
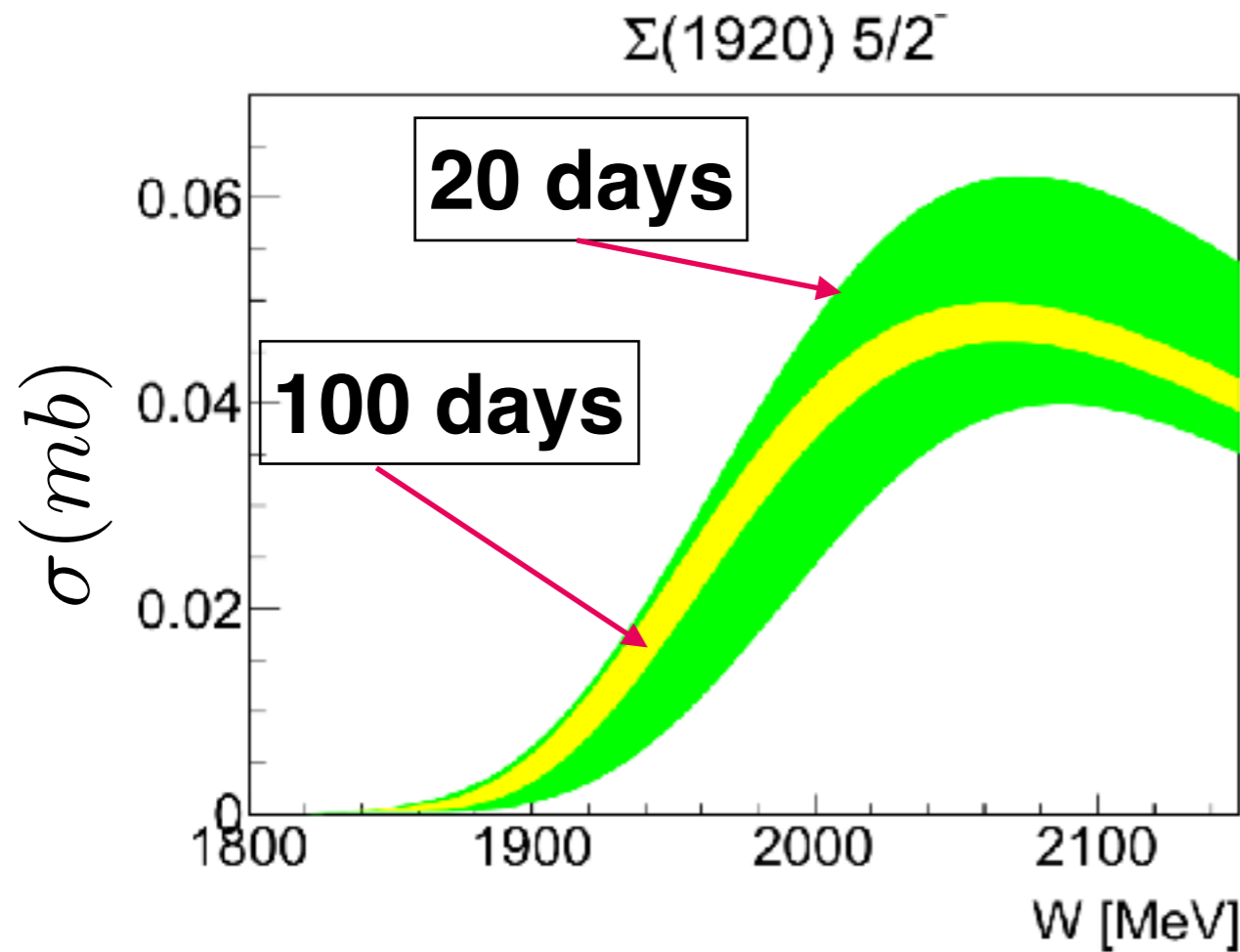
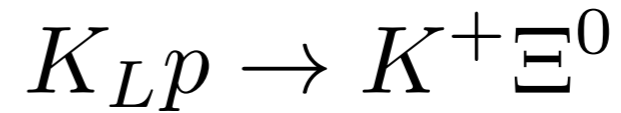

Obviously: at least 100 days needed to get precise solution

Bonn-Gatchina PWA

Diff. Cross Section

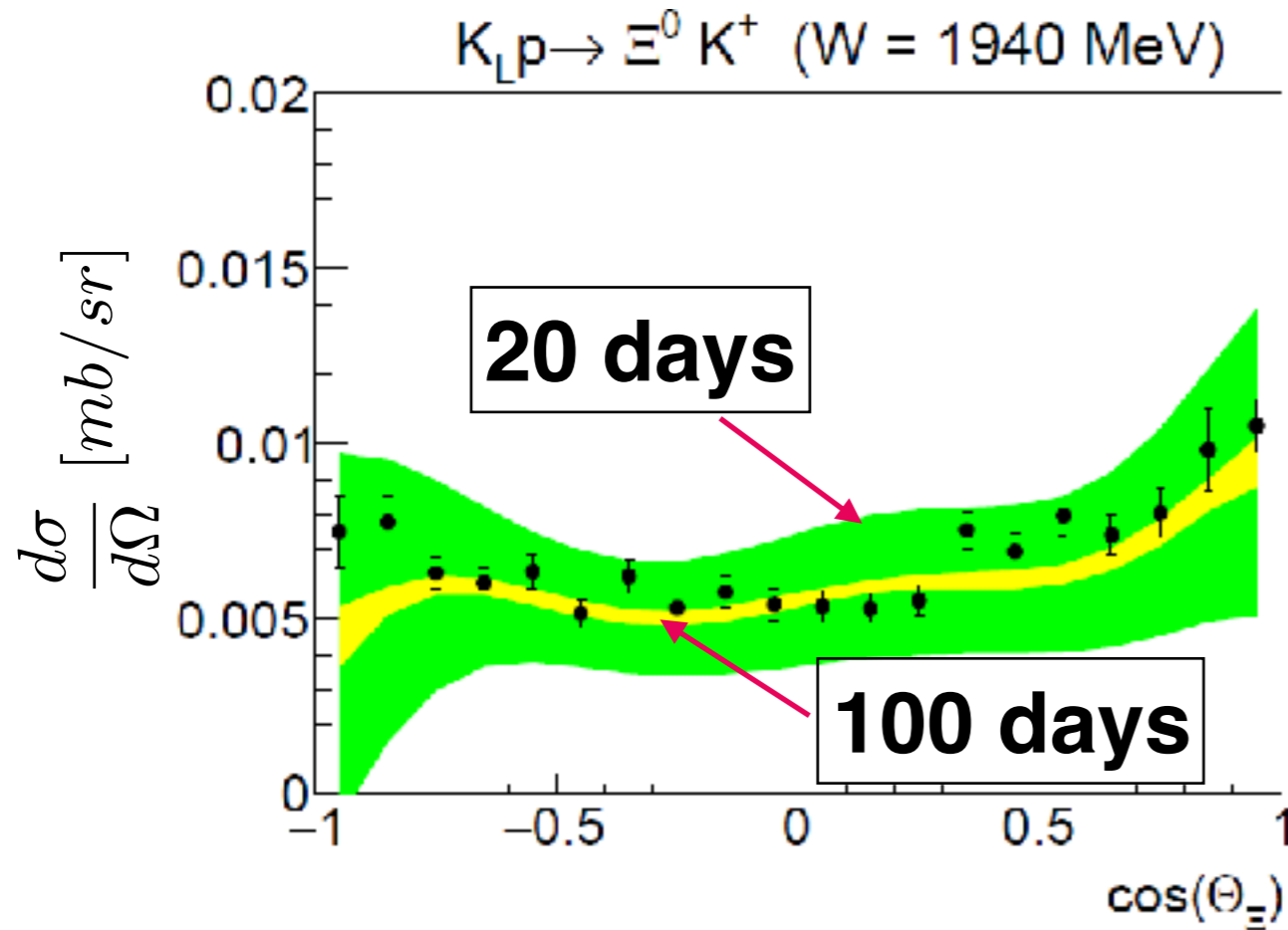

Polarization

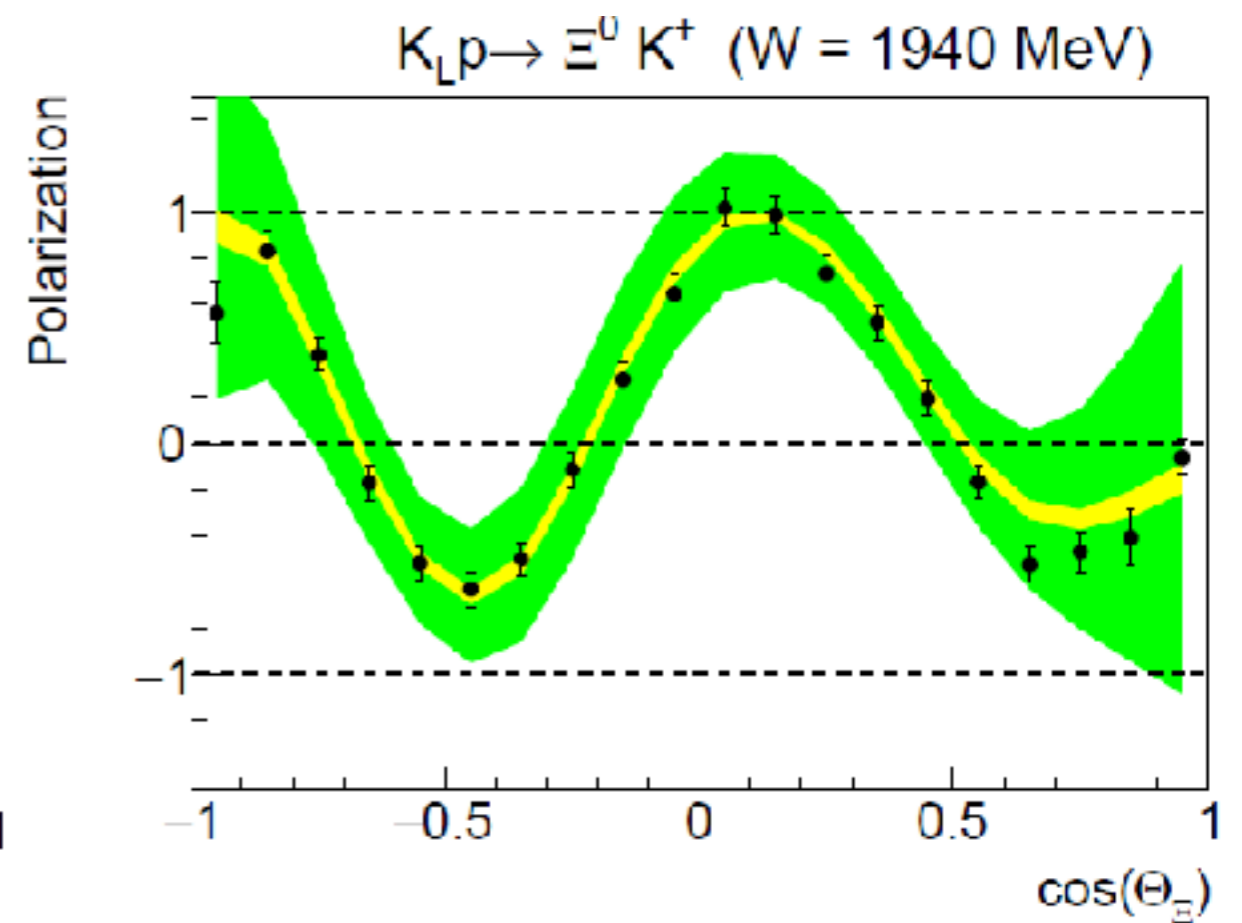

Again: **at least 100 days** to get precise solution

Some Numerical Results

Simulated $\Sigma(1920) \ 5/2^-$

$$\left\{ \begin{array}{l} 100d \ M = \underline{1.923} \pm 0.010 \pm 0.010 \text{ GeV} \\ \quad \Gamma = 0.321 \pm 0.01 \pm 0.010 \text{ GeV} \\ 20d \ M = \underline{1.977} \pm 0.021 \pm 0.025 \text{ GeV} \\ \quad \Gamma = 0.327 \pm 0.025 \pm 0.025 \text{ GeV} \end{array} \right.$$

PDG2018 $M = 1.775 \pm 0.005$

LQCD M=

**2.027 GeV
2.487 GeV
2.659 GeV
2.781 GeV**

**R.G. Edwards et al.,
PRD 87,no.5. 054506 (2013)**

LQCD Results are still in progress

Comparison of KLF Measurements and LQCD

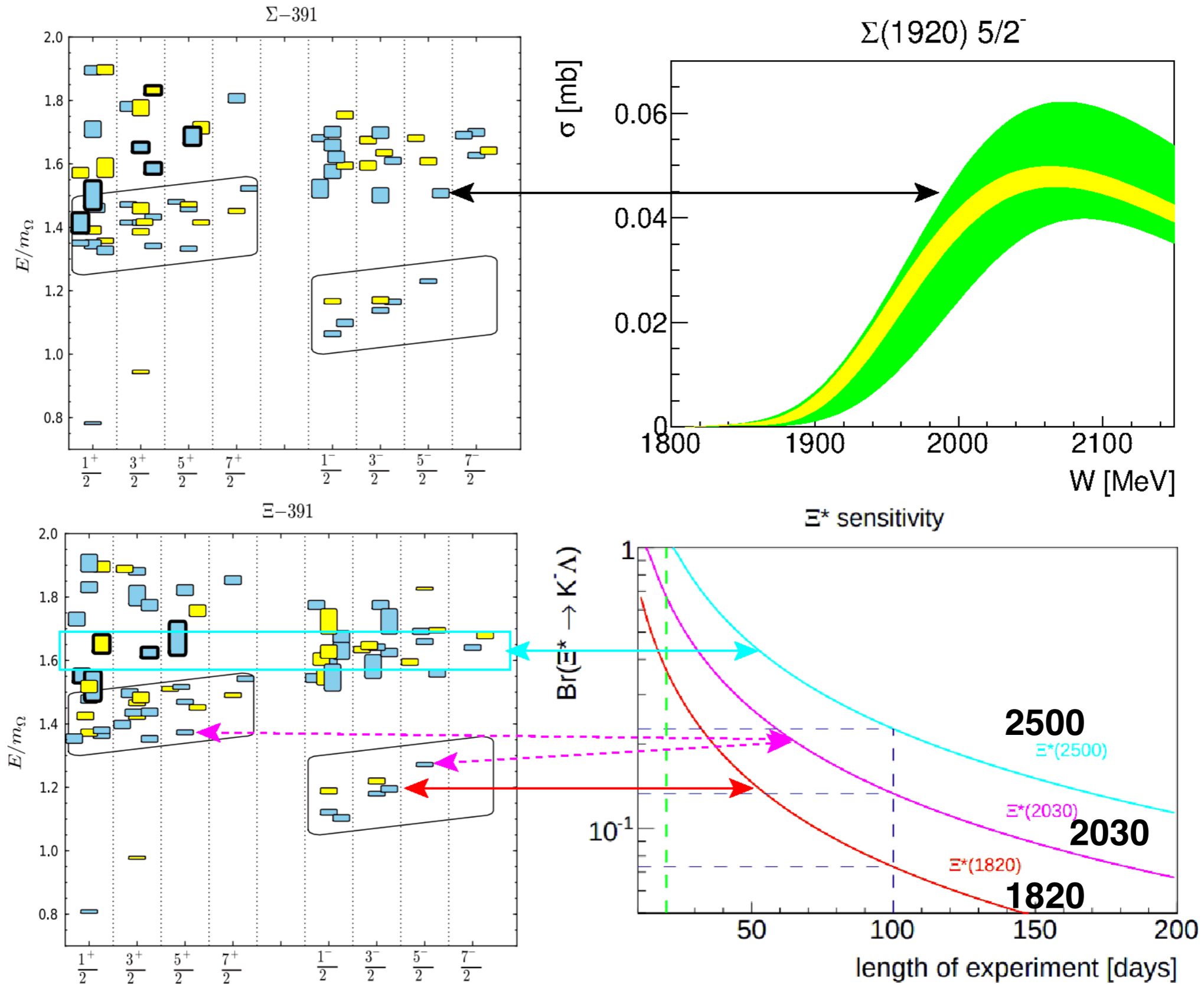

Summary of Hyperon Spectroscopy

We showed that KLF sensitivity with 100 days of running will allow to discover many states with a good precision

Why should it be done with KL beam?

This is the only realizable way to observe s-channel resonances having all momenta of KL at once

Why should it be done at JLab?

Because nowhere else in existing facilities this can be done

Why should we care that there are dozens of missing states?

... The new capabilities of the 12-GeV era facilitate a detailed study of baryons containing two and three strange quarks. Knowledge of the spectrum of these states will further enhance our understanding of the manifestation of QCD in the three-quark arena.

2015 Long Range Plan for Nuclear Science

Strange Meson Spectroscopy

$K\pi$ Scattering

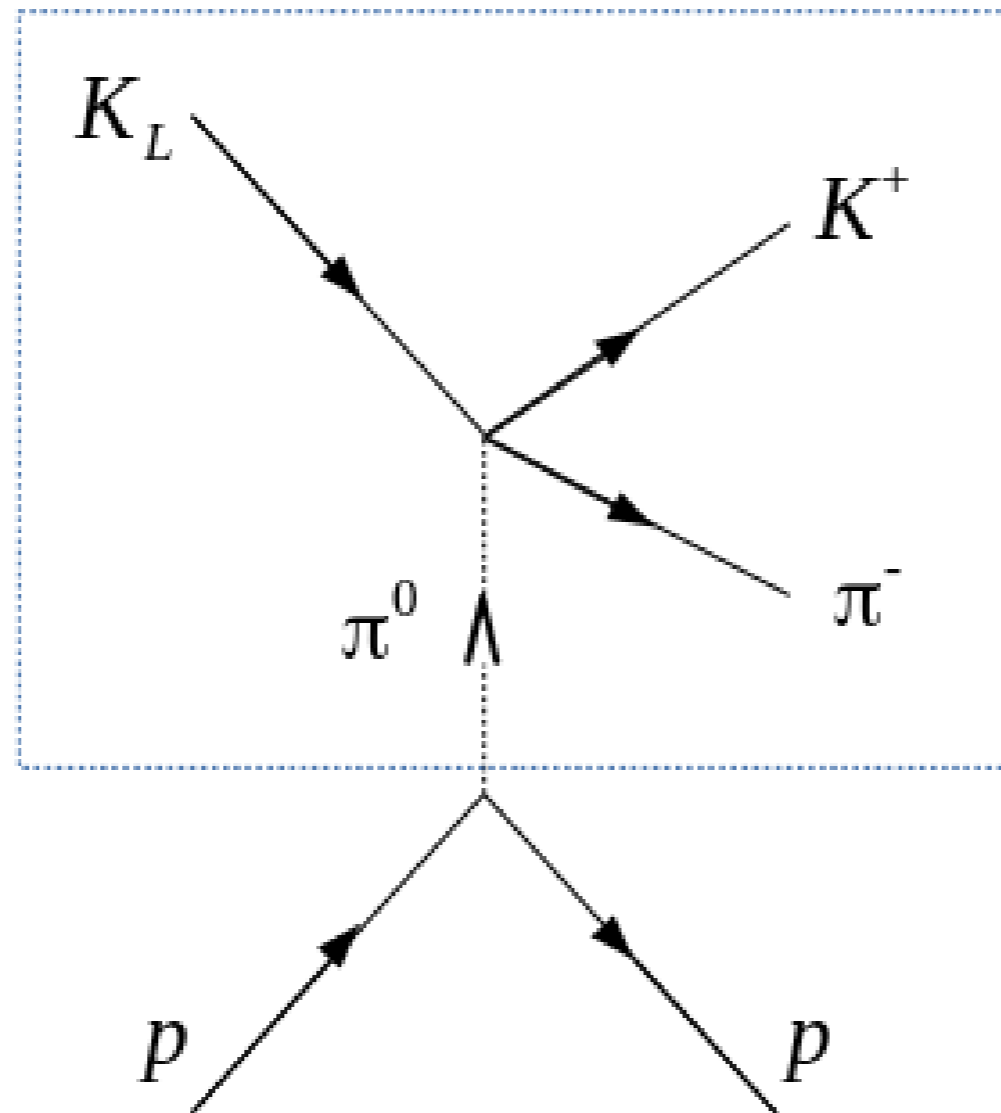

Proposed Measurements

SLAC

$$K^- \pi^+ \rightarrow K^- \pi^+$$

Belle

$$\tau \rightarrow K \pi \nu_\tau$$

KLF

$$K_L \pi^0 \rightarrow K^+ \pi^-$$

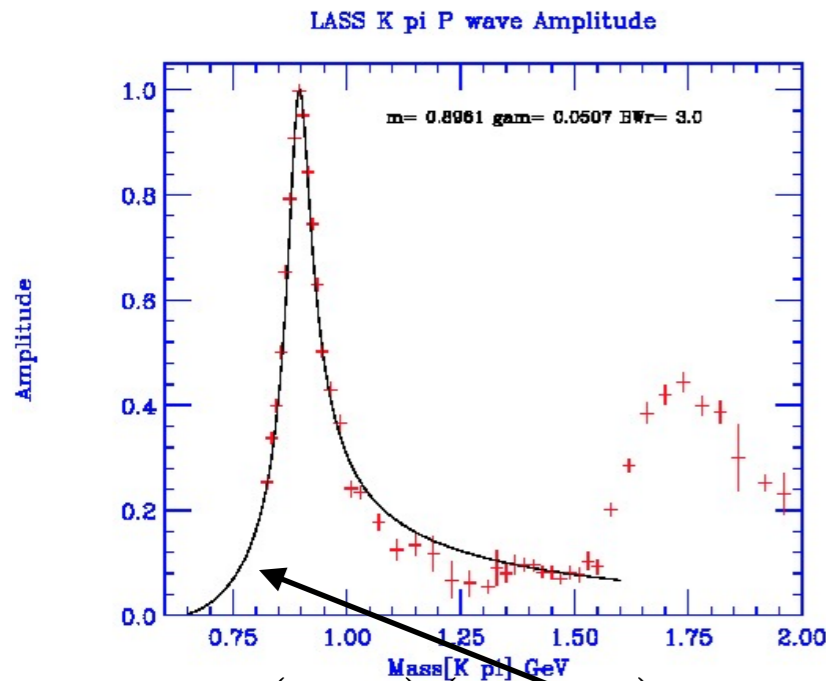

$M(K\pi)$ (GeV)

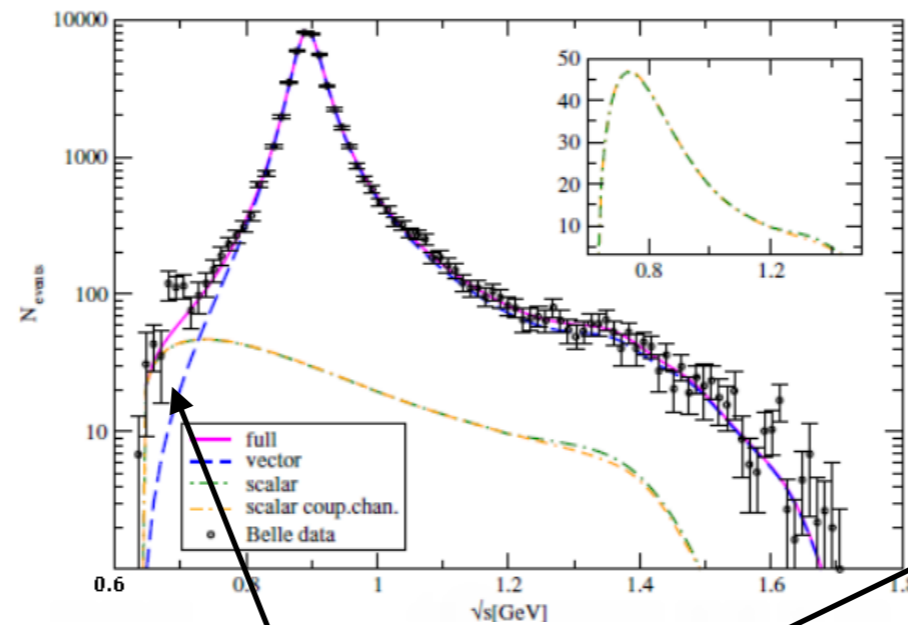

$M(K\pi)$ (GeV)

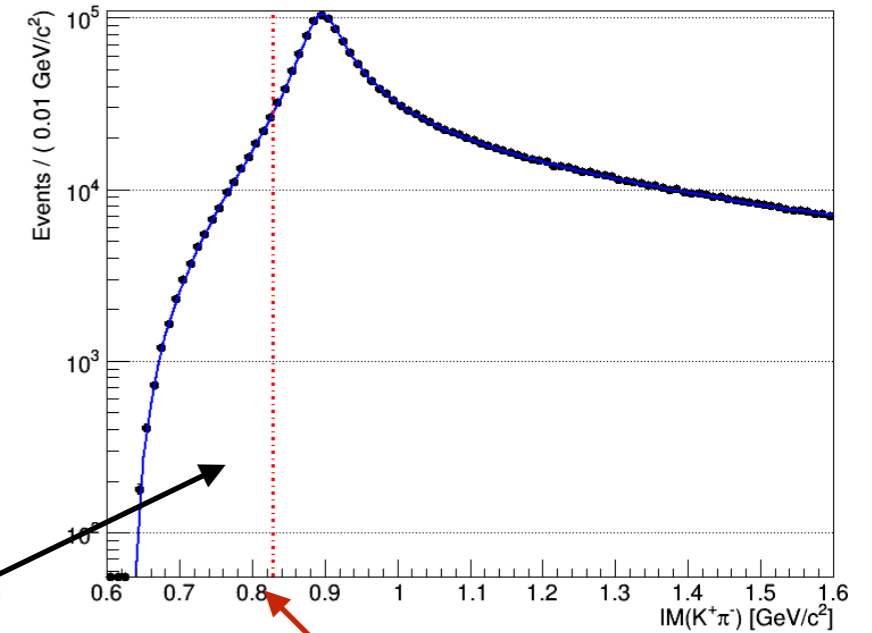

$M(K\pi)$ (GeV)

region of $\mathcal{K}(800)$

SLAC Lower limit

Transfer Four Momentum Efficiency

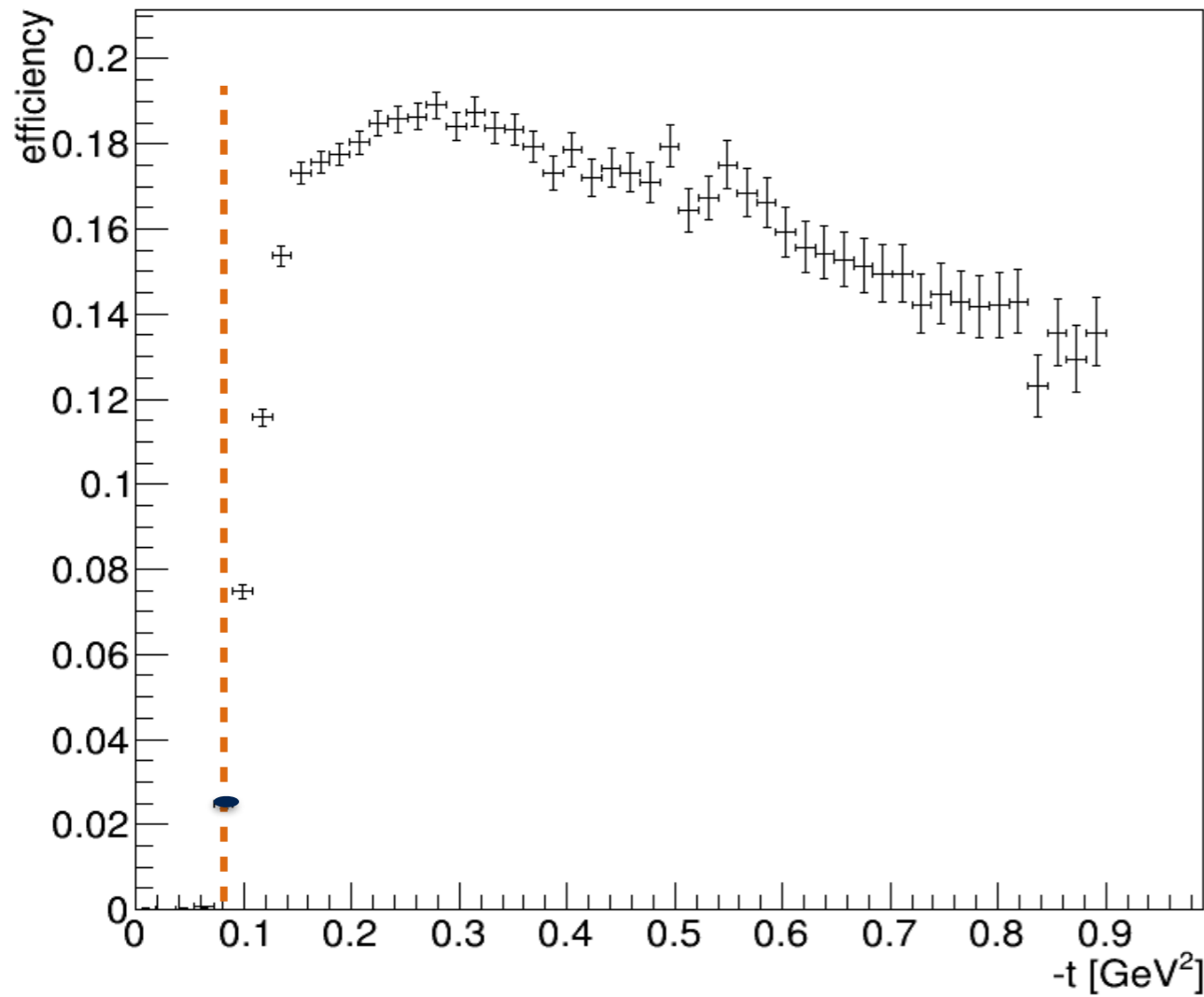

Transfer Four Momentum Efficiency

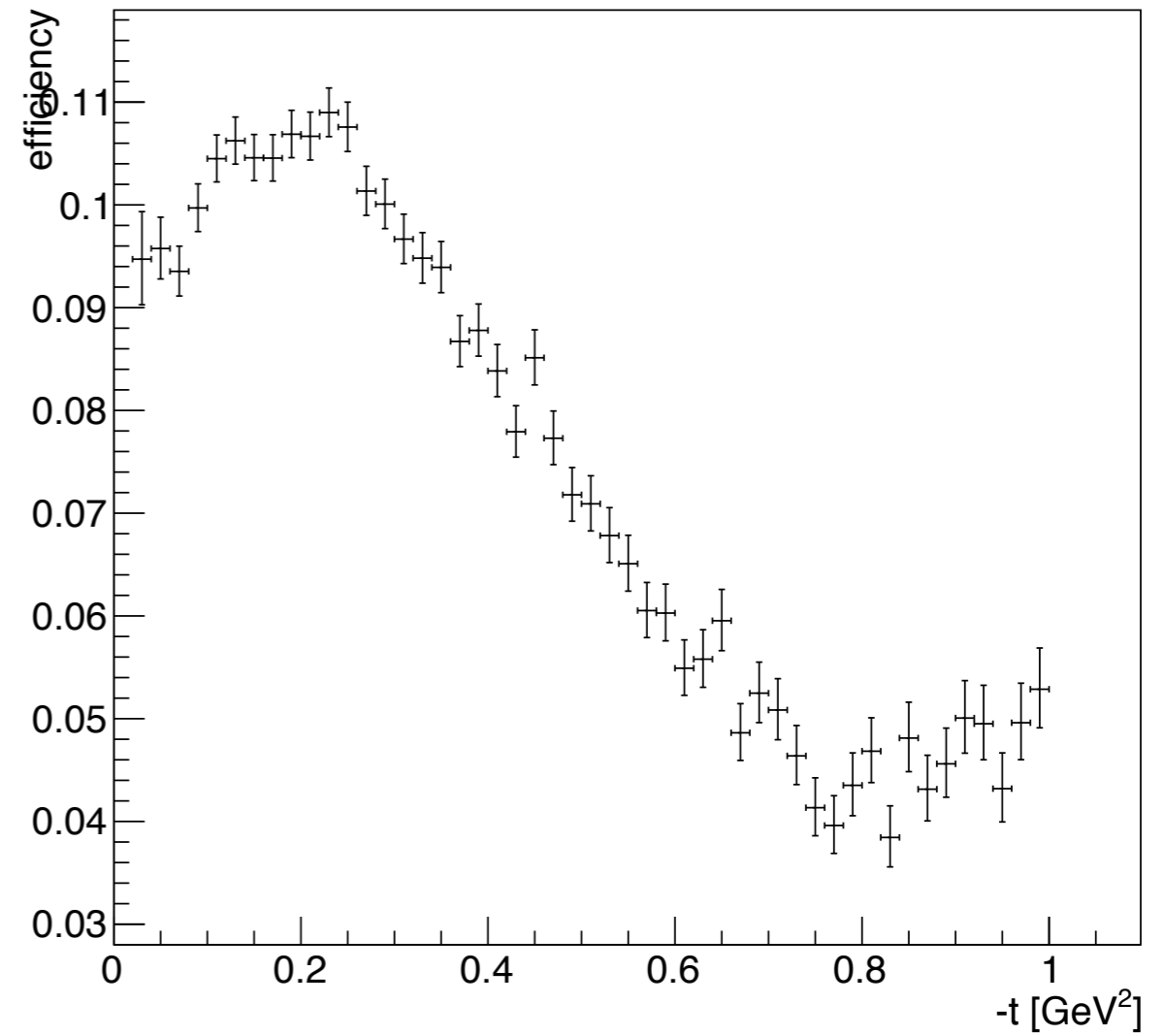

**t-down to 0.08 GeV² is measurable
with proton being detected**

**t-down to pion pole
proton missing**

$K\pi$ Scattering

(proton detected)

Four Momentum Resolution for $K_L p \rightarrow K^+ \pi^- p$

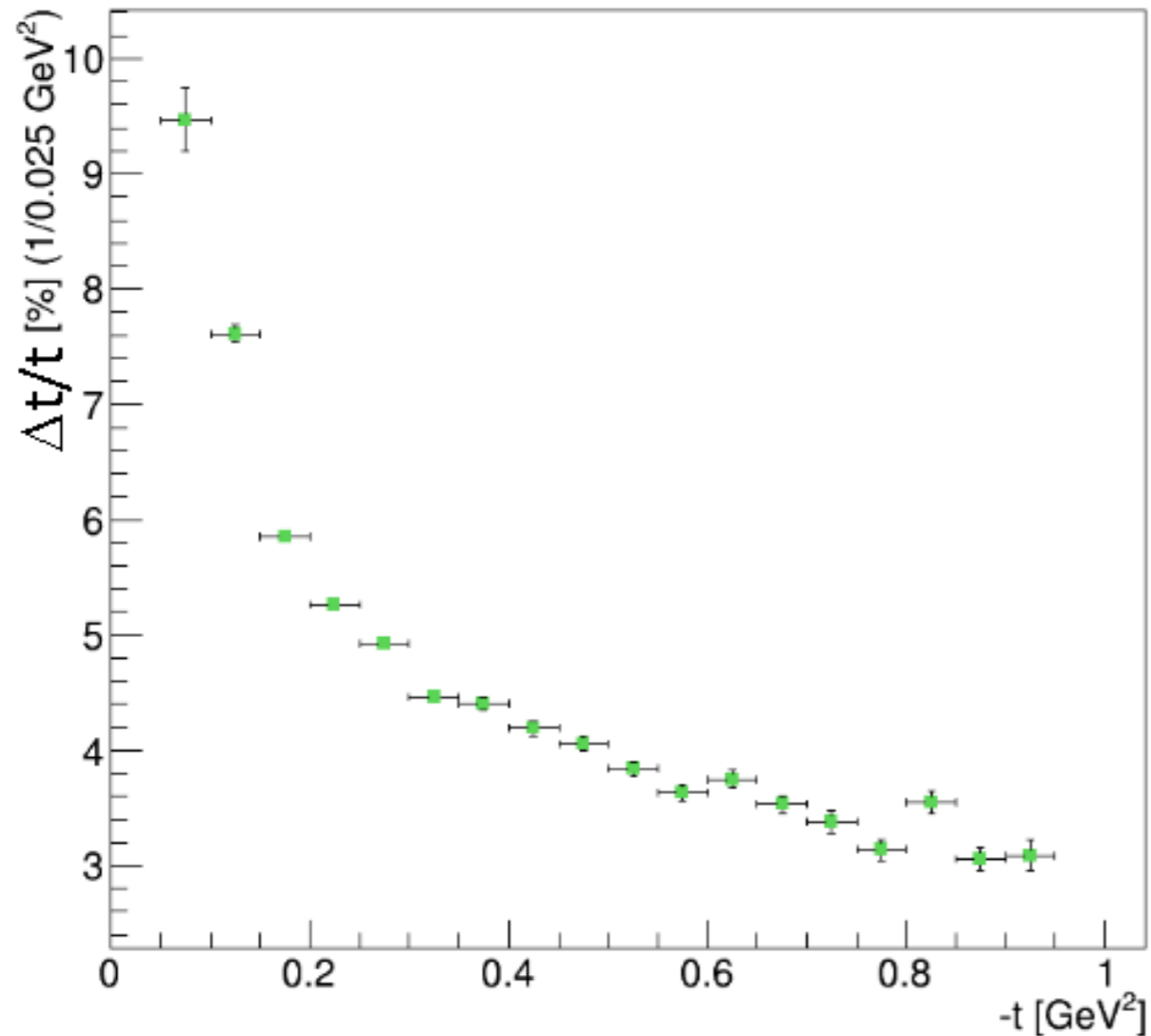

-Good resolution at low- t is needed to be close to pion pole

$K^+ \pi^-$ Invariant Mass Resolution for $K_L p \rightarrow K^+ \pi^- p$

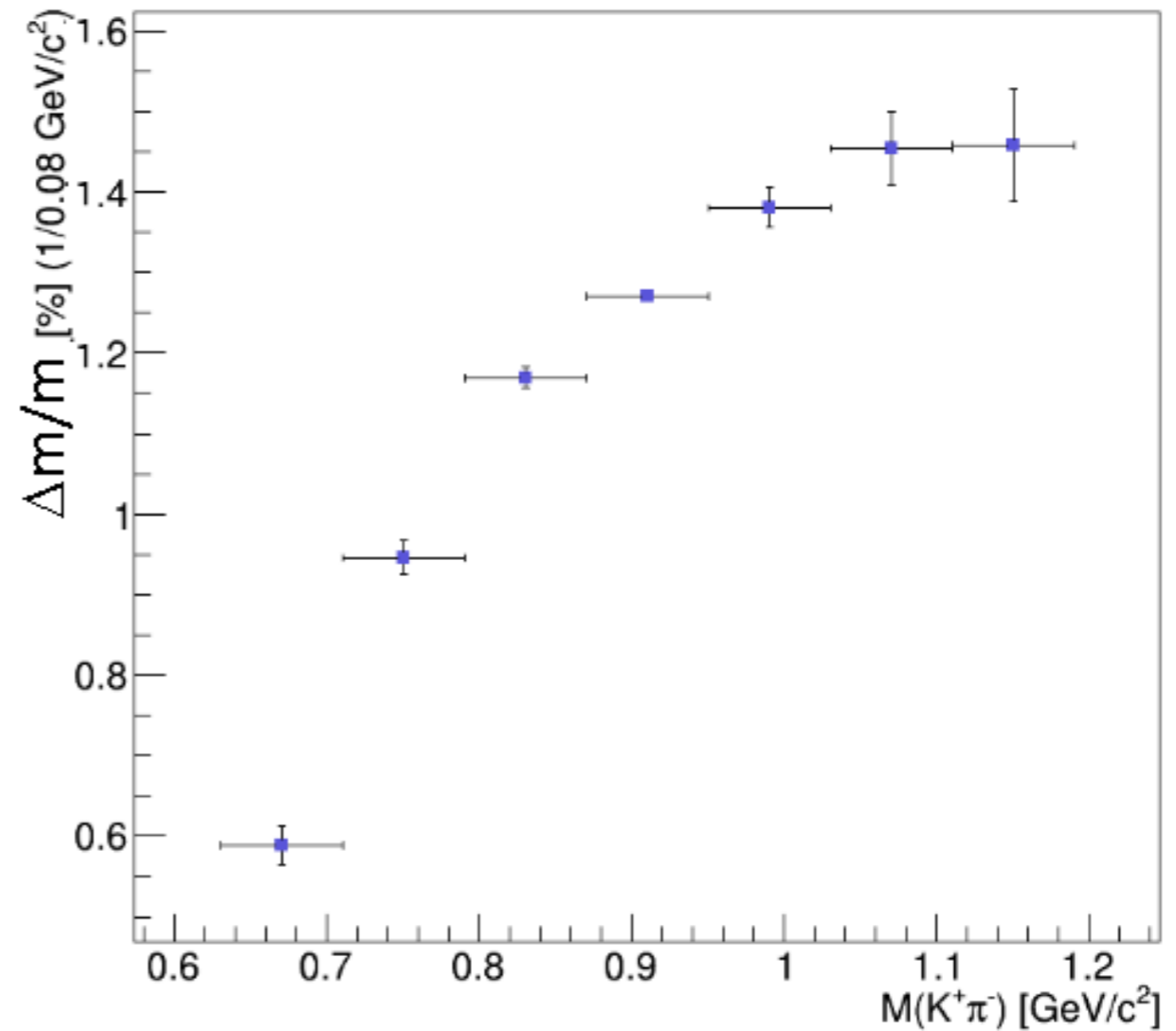

-Binning in $\sim 10 \text{ MeV}$ will cover almost entire elastic K - π scattering range

$K\pi$ Scattering

(proton missing)

Four Momentum Resolution for $K_L p \rightarrow K^+ \pi^- (p)$

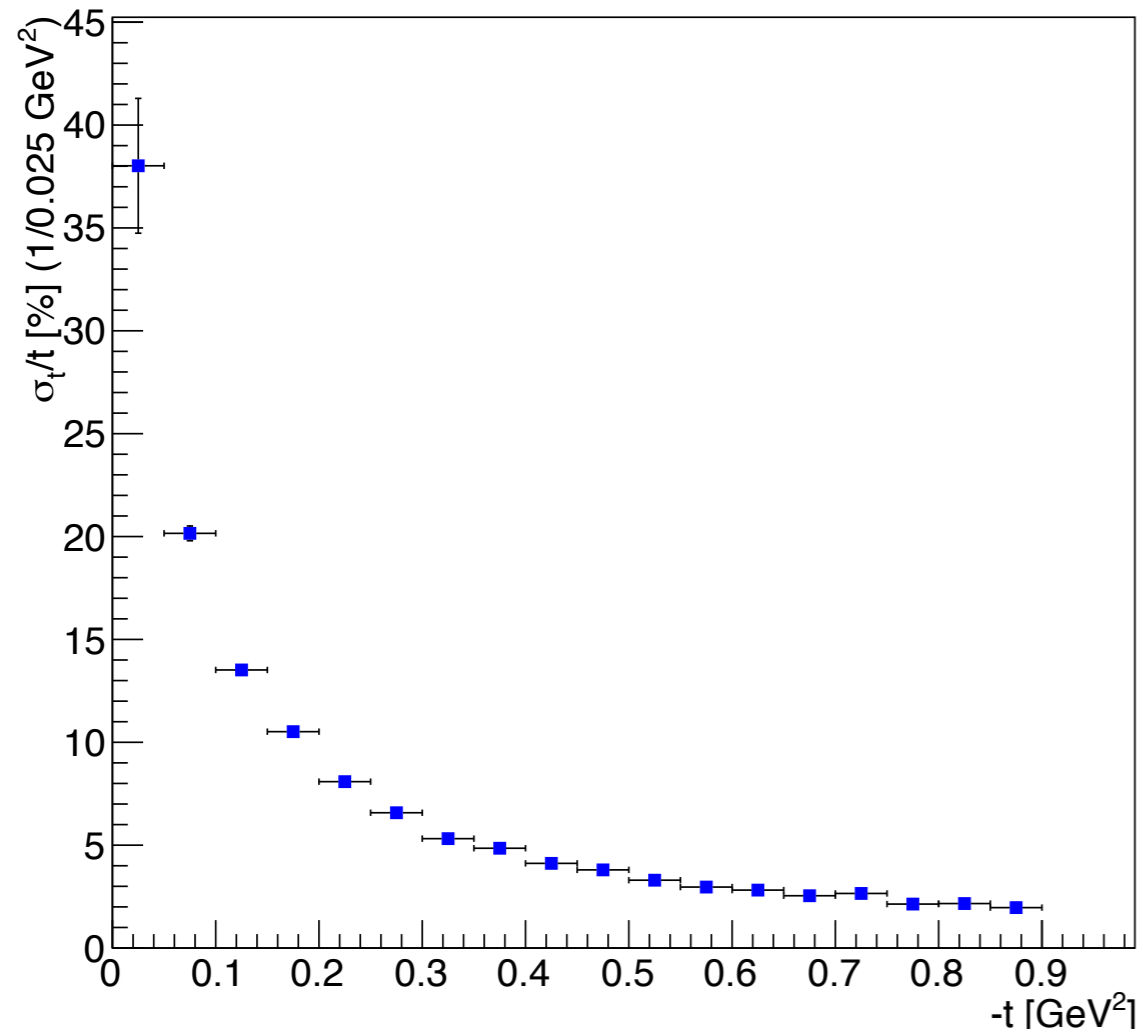

$K^+ \pi^-$ Invariant Mass Resolution for $K_L p \rightarrow K^+ \pi^- (p)$

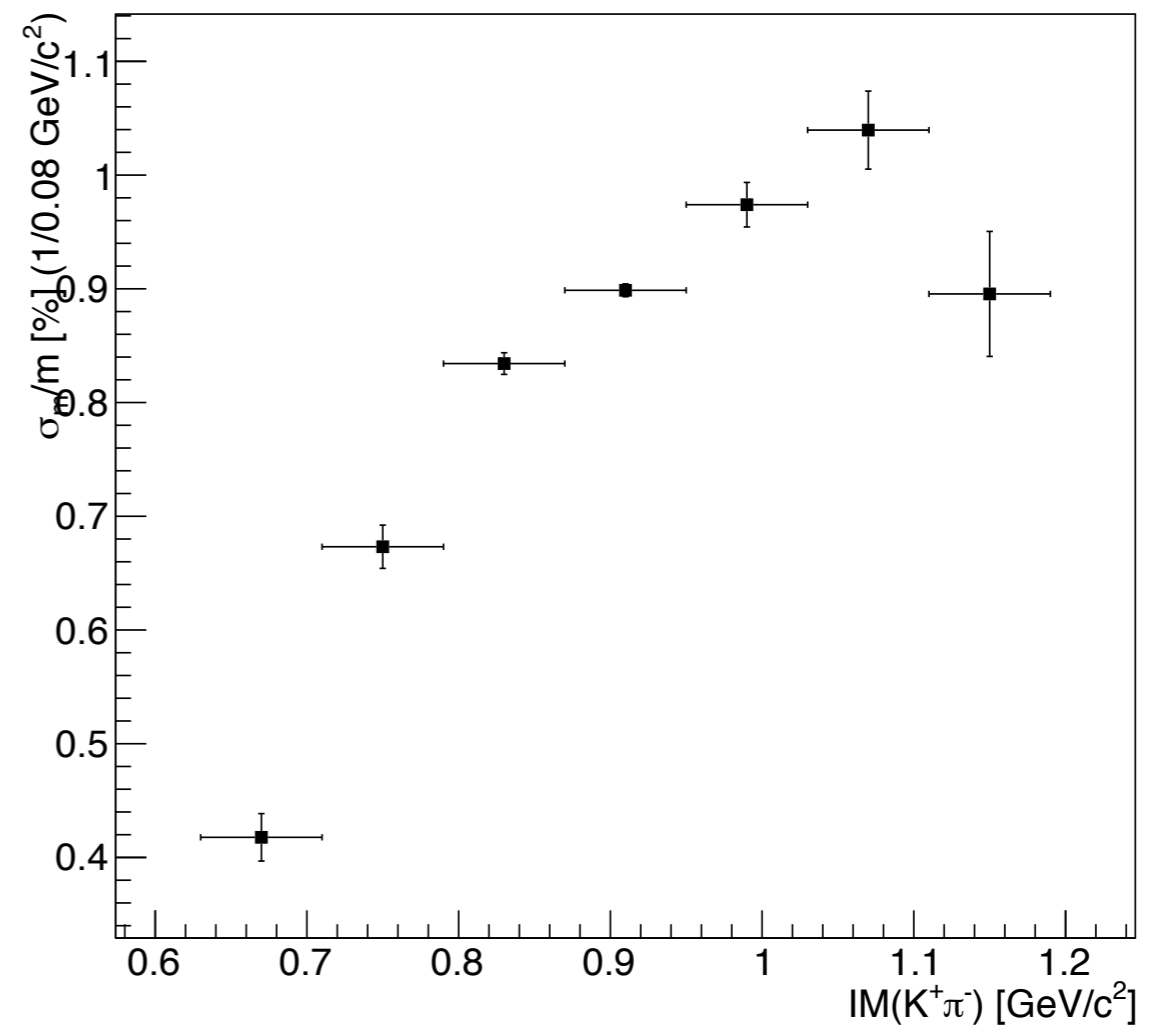

Missing Mass of $K^+\pi^-$ system

MM($K^+\pi^-$) vs $p(K_L)$

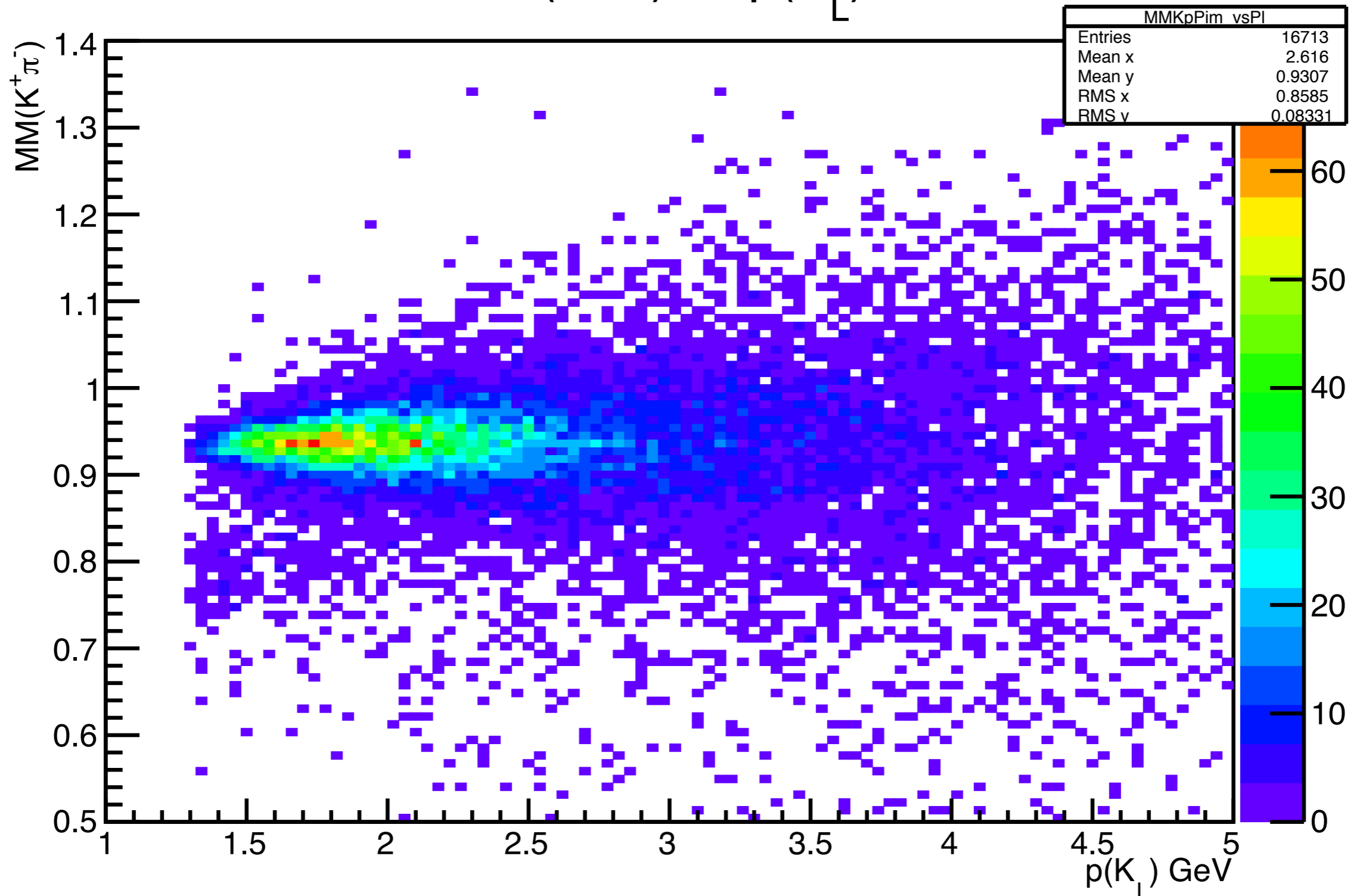

Missing Mass $MM(K^+\pi^-)GeV$

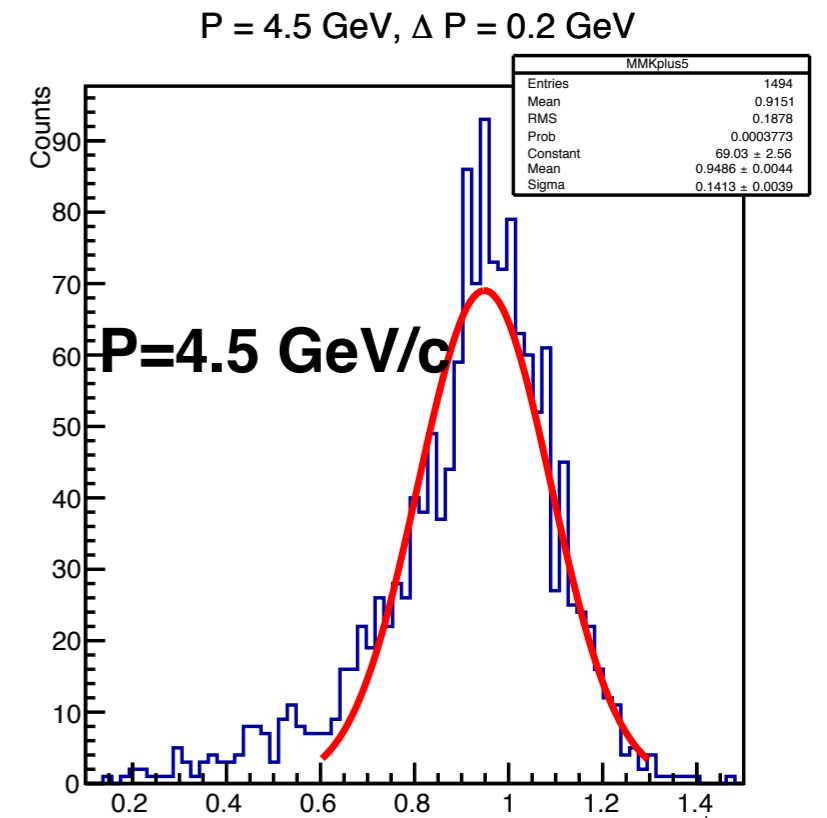
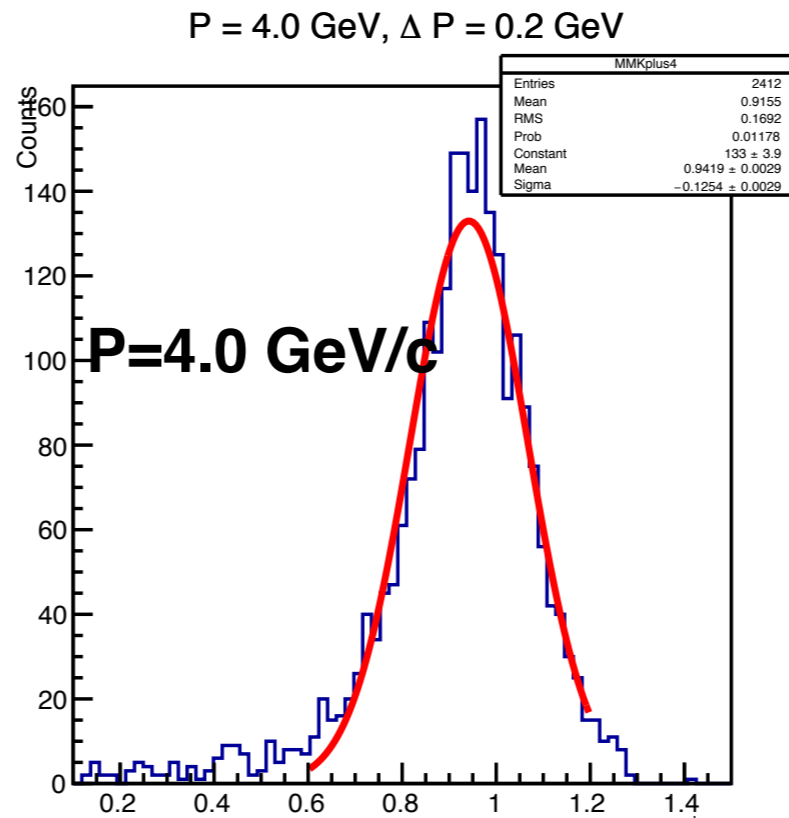
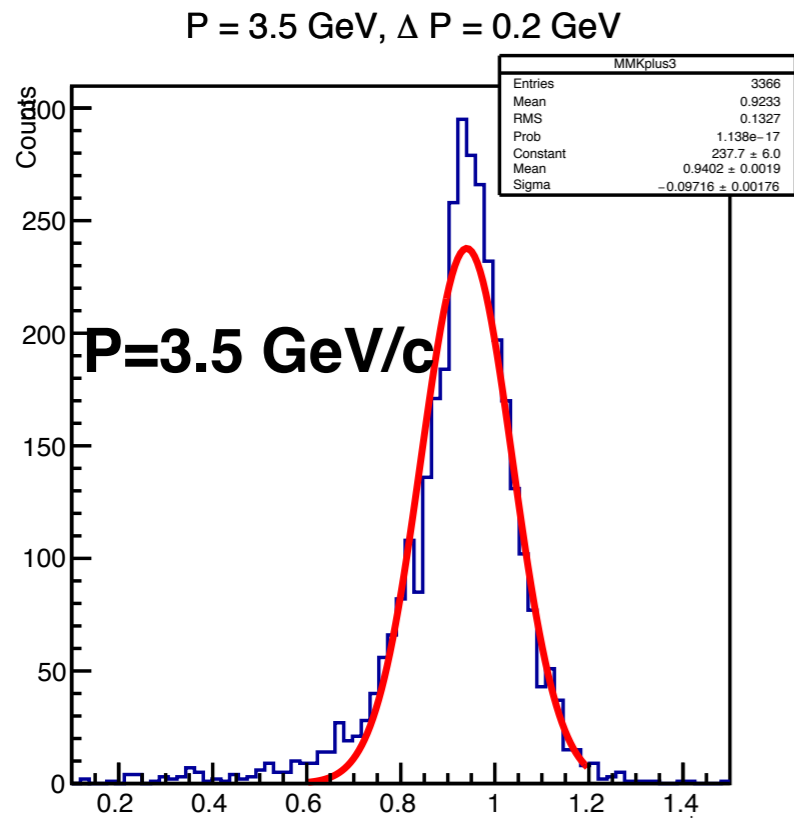
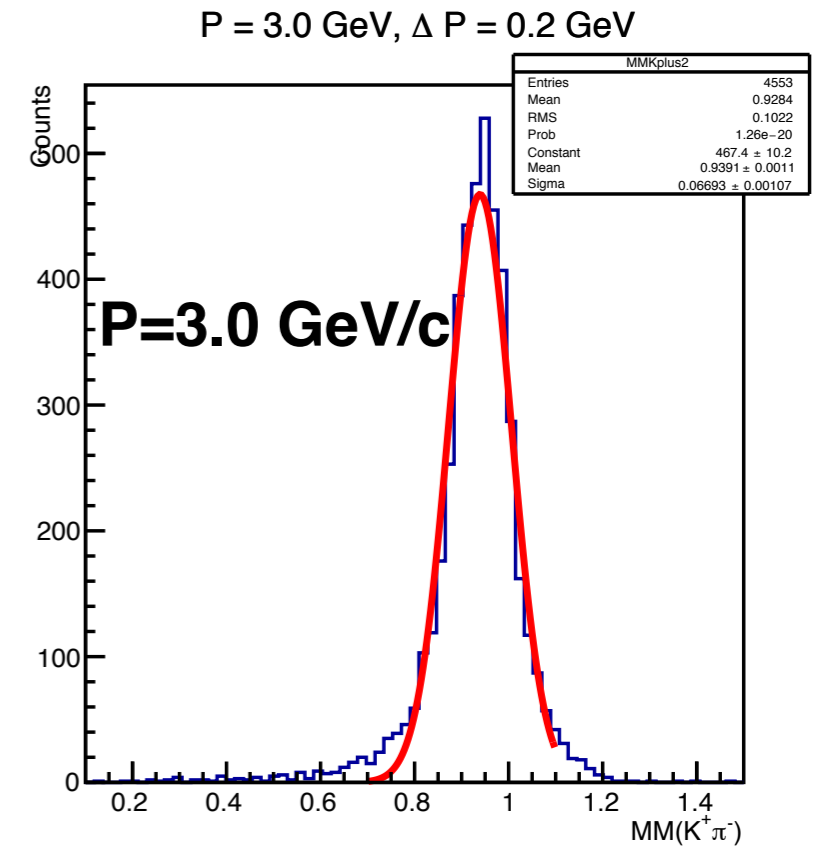
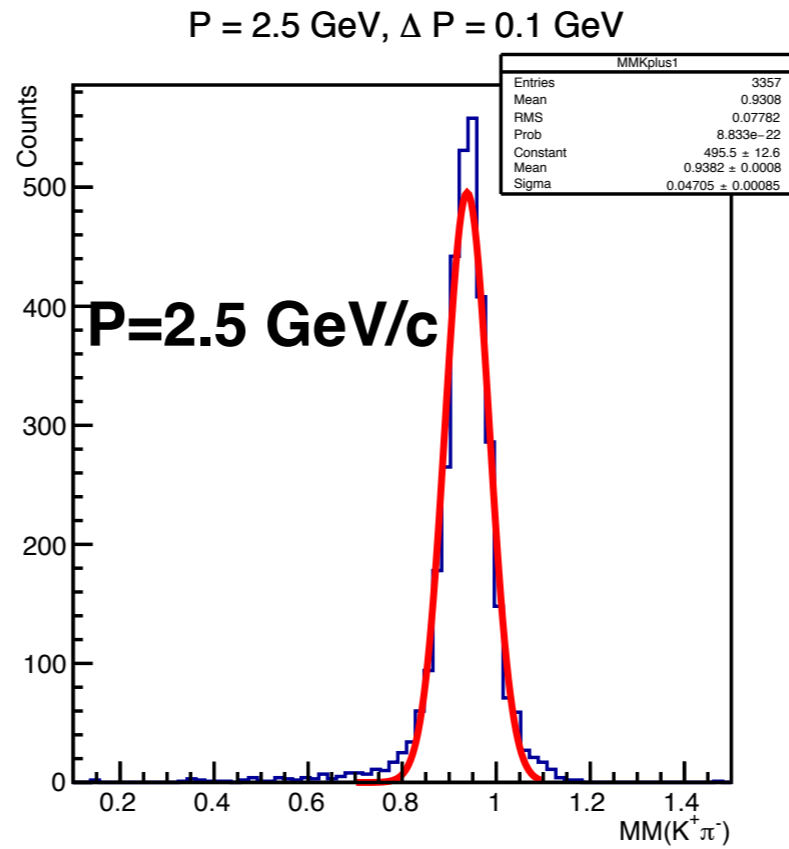
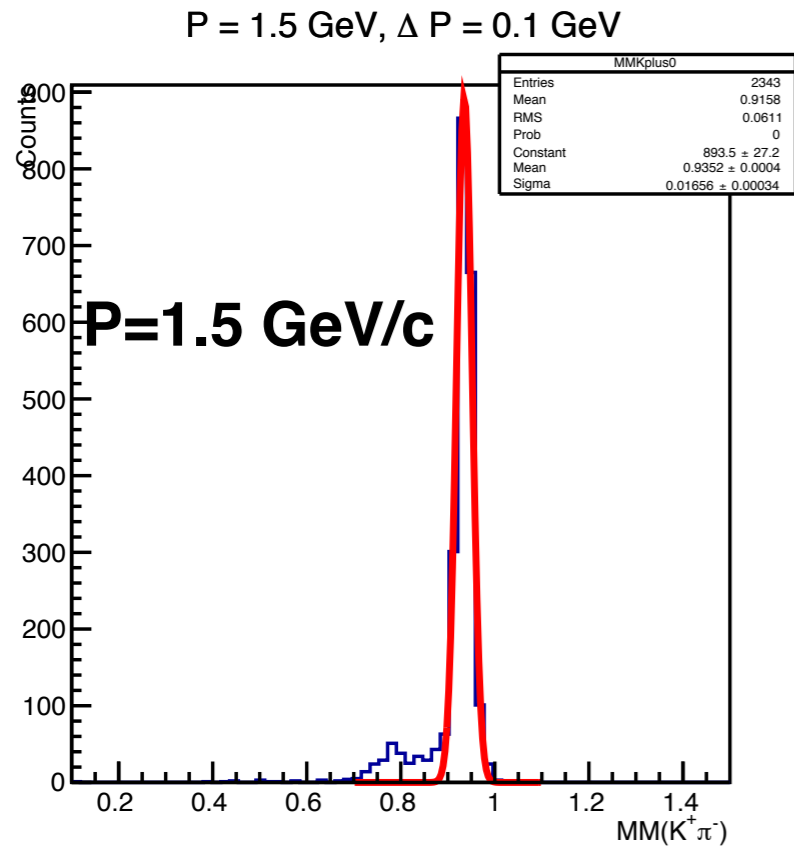

Proton reconstructed via missing mass

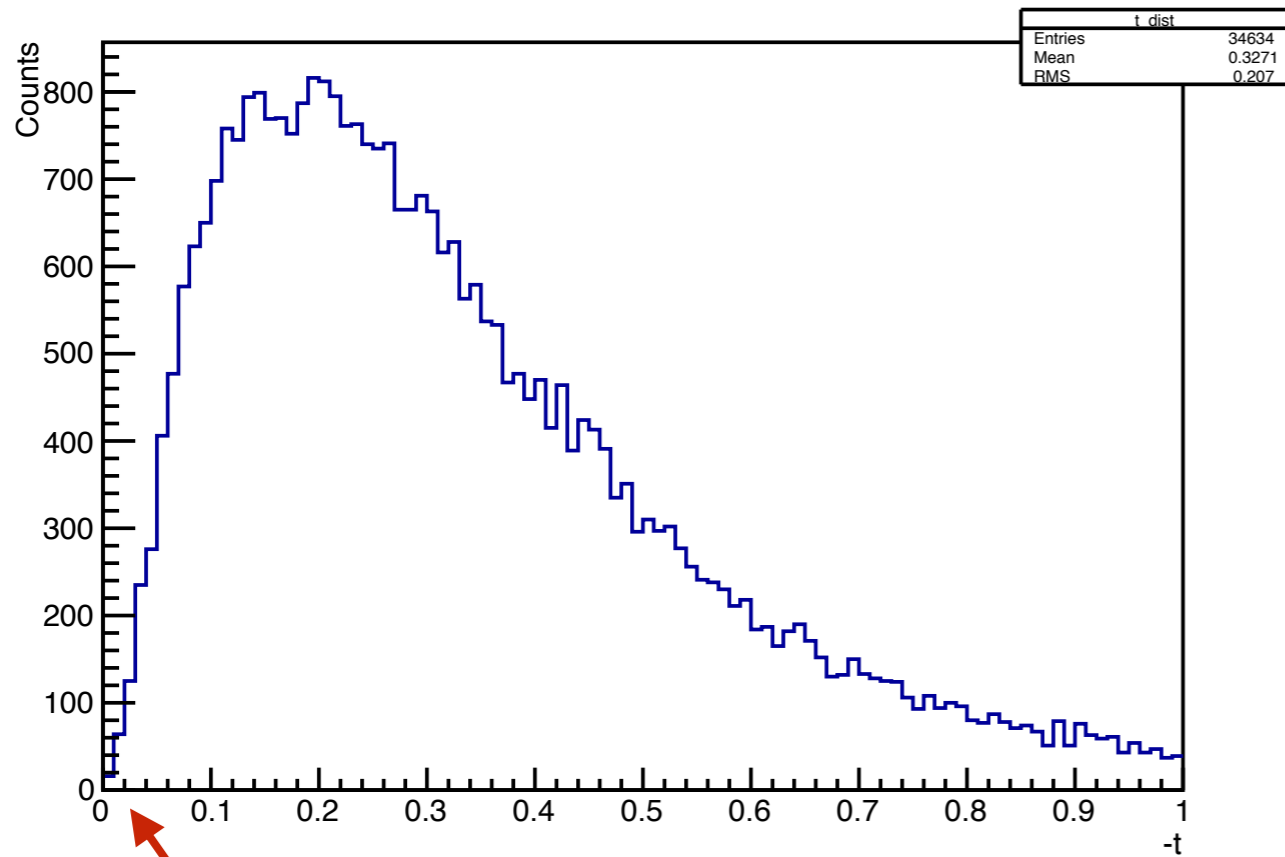

$-t, (\text{GeV}/c)^2$

Down to pion pole

K_L beam profile

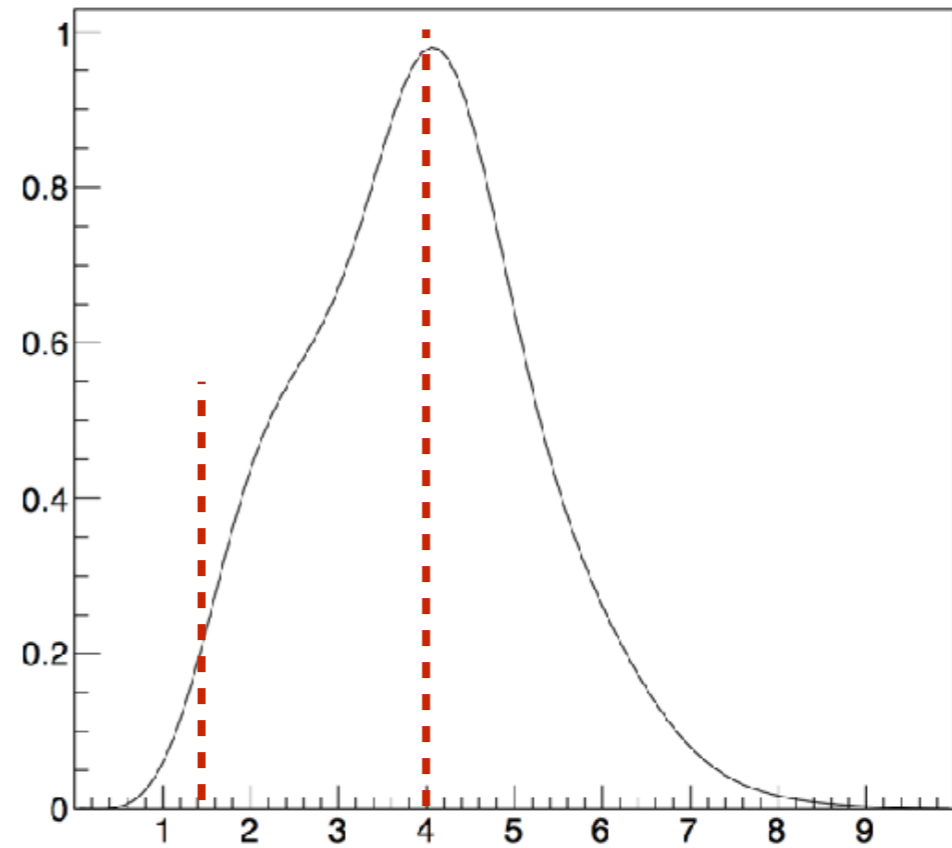

$P(K_L), \text{GeV}/c$

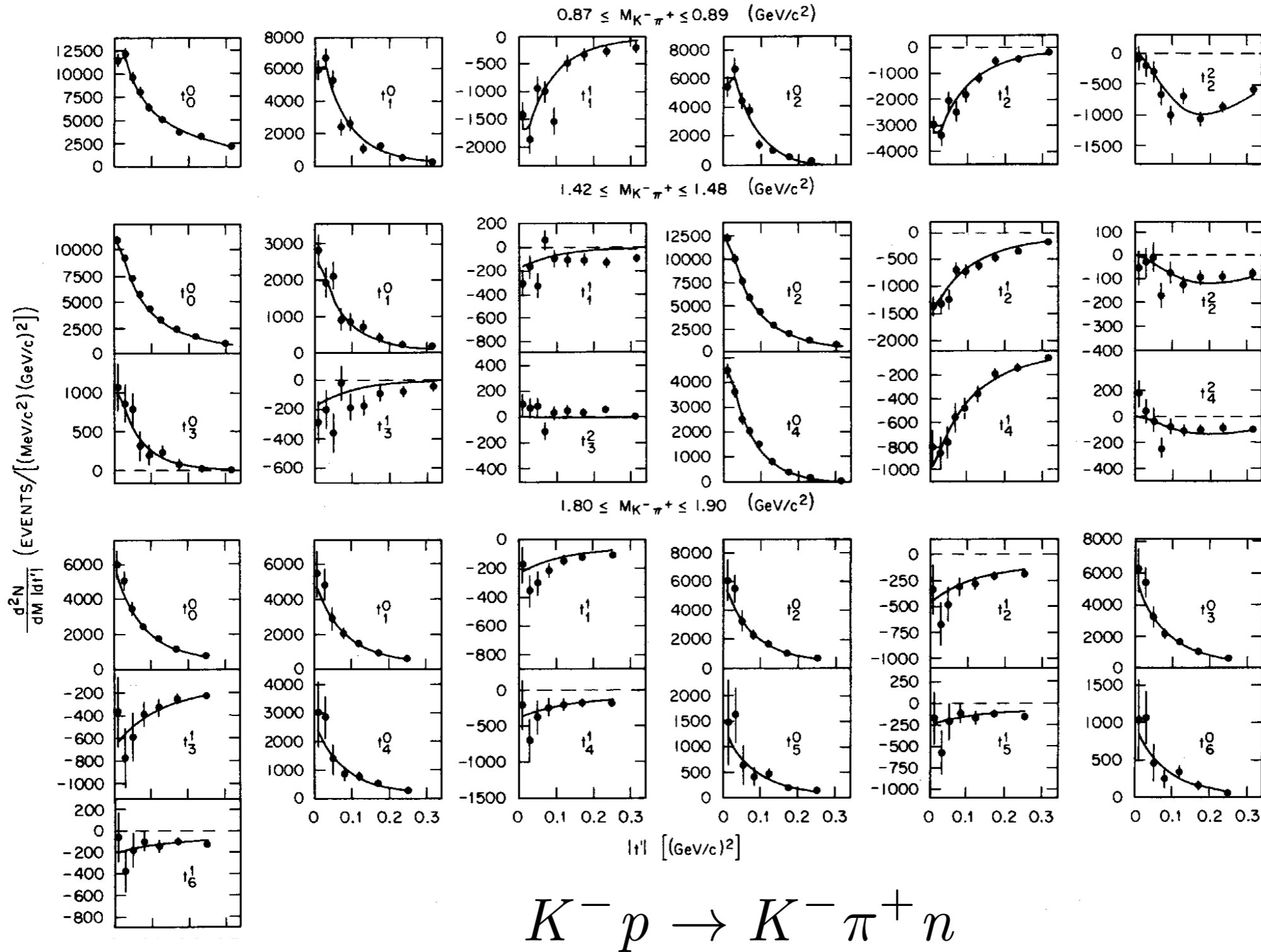
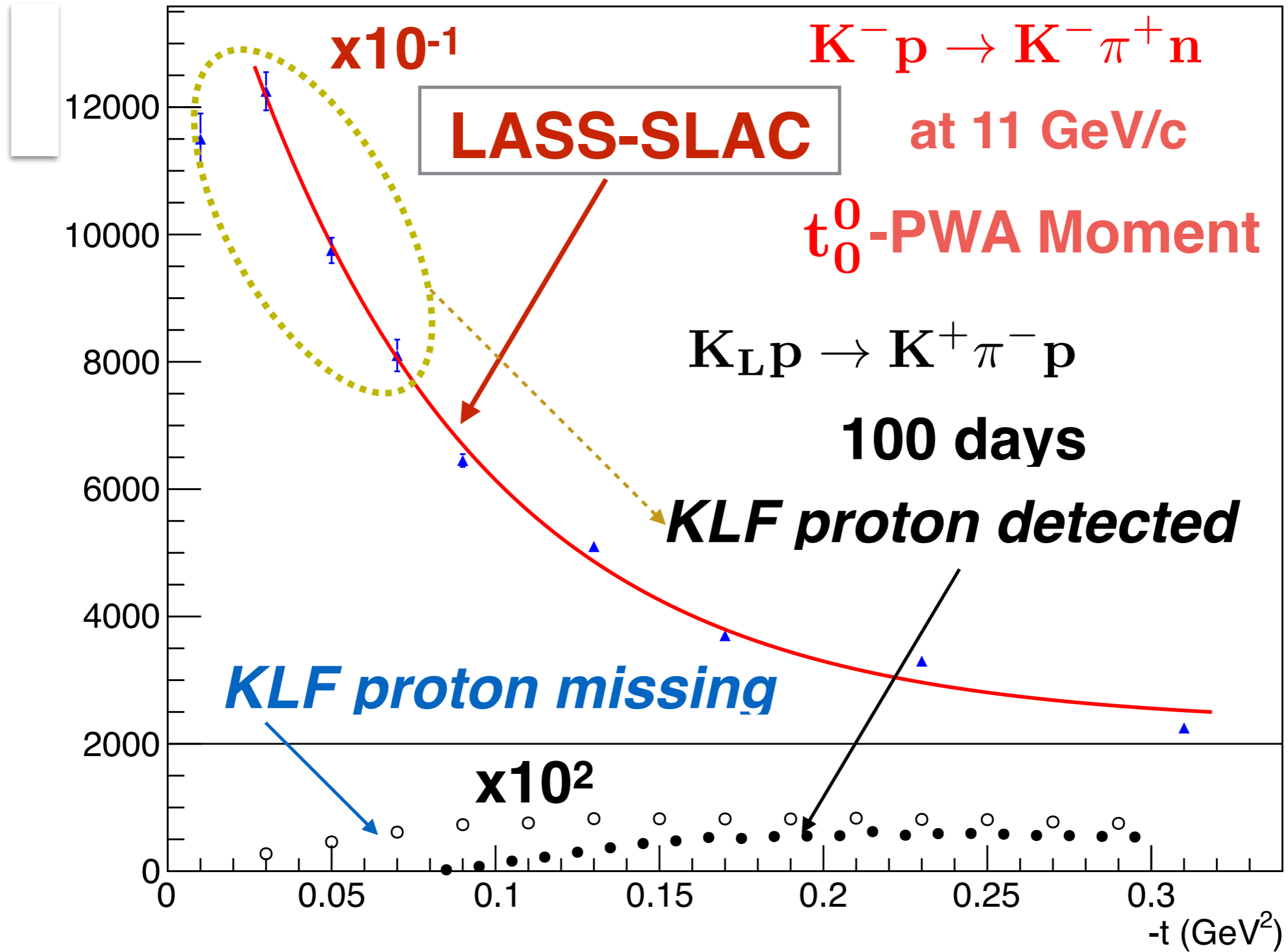

Fig. 9. The acceptance corrected unnormalized $K^- \pi^+$ moments as a function of $|t'|$. Three different mass regions are shown; $0.87 \leq M_{K\pi} \leq 0.89 \text{ GeV}/c^2$, $1.42 \leq M_{K\pi} \leq 1.48 \text{ GeV}/c^2$, and $1.80 \leq M_{K\pi} \leq 1.90 \text{ GeV}/c^2$. The curves are the result of a fit to the production model described in the text.

$$M_{K-\pi^+} = 0.87 - 0.89 \text{ GeV}$$



Two orders of magnitude higher statistics with KLF plus down to the threshold of $M(K-\pi)$!

Projected Measurements

$I=3/2+1/2$

S -wave

SLAC Data

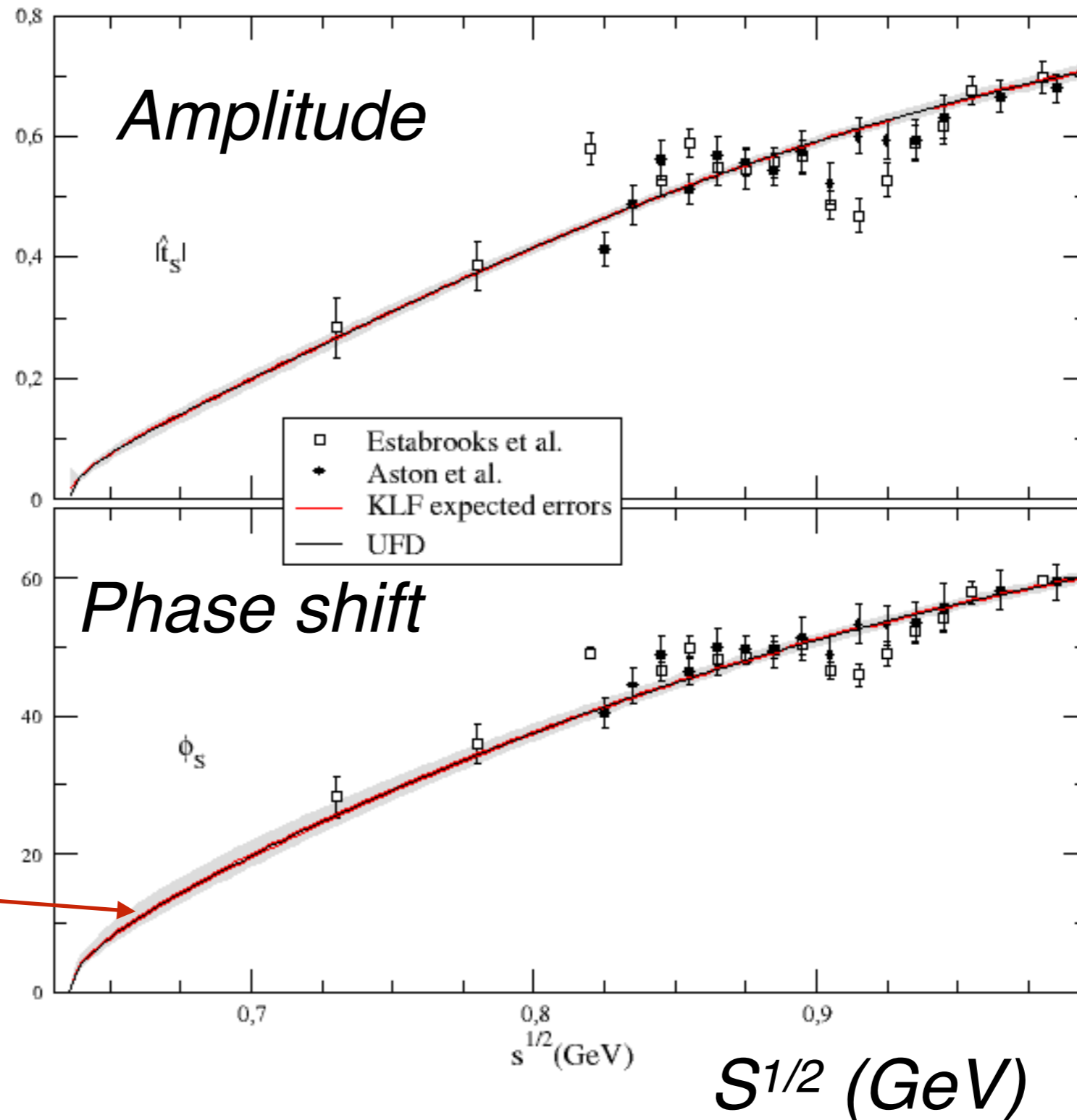

Scalar Meson Nonet

$$J^{PC} = 0^{++}$$

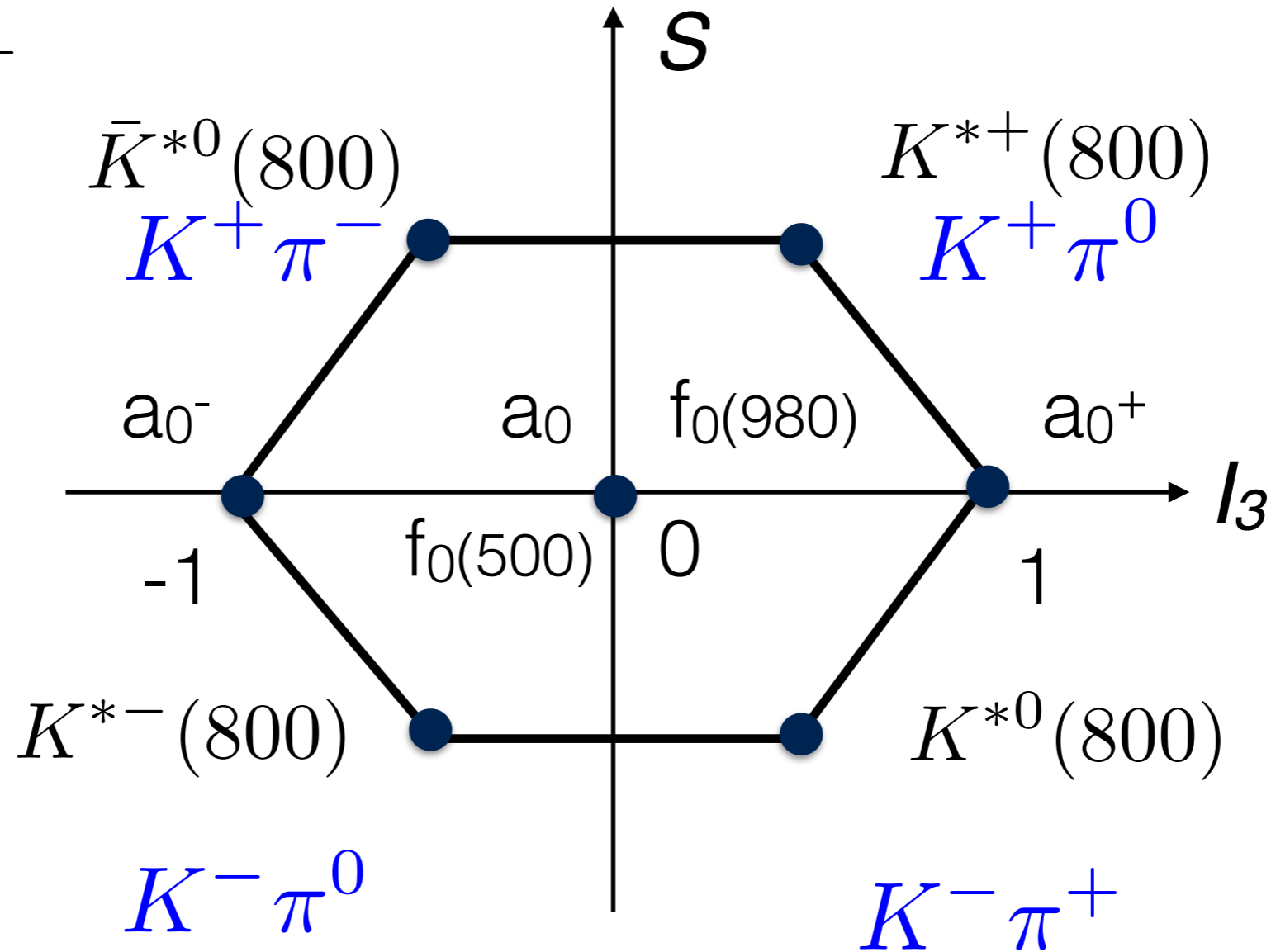

Four states called \mathcal{K}

still need further confirmation(PDG)

We can measure all of them

Width and Mass of κ (800)

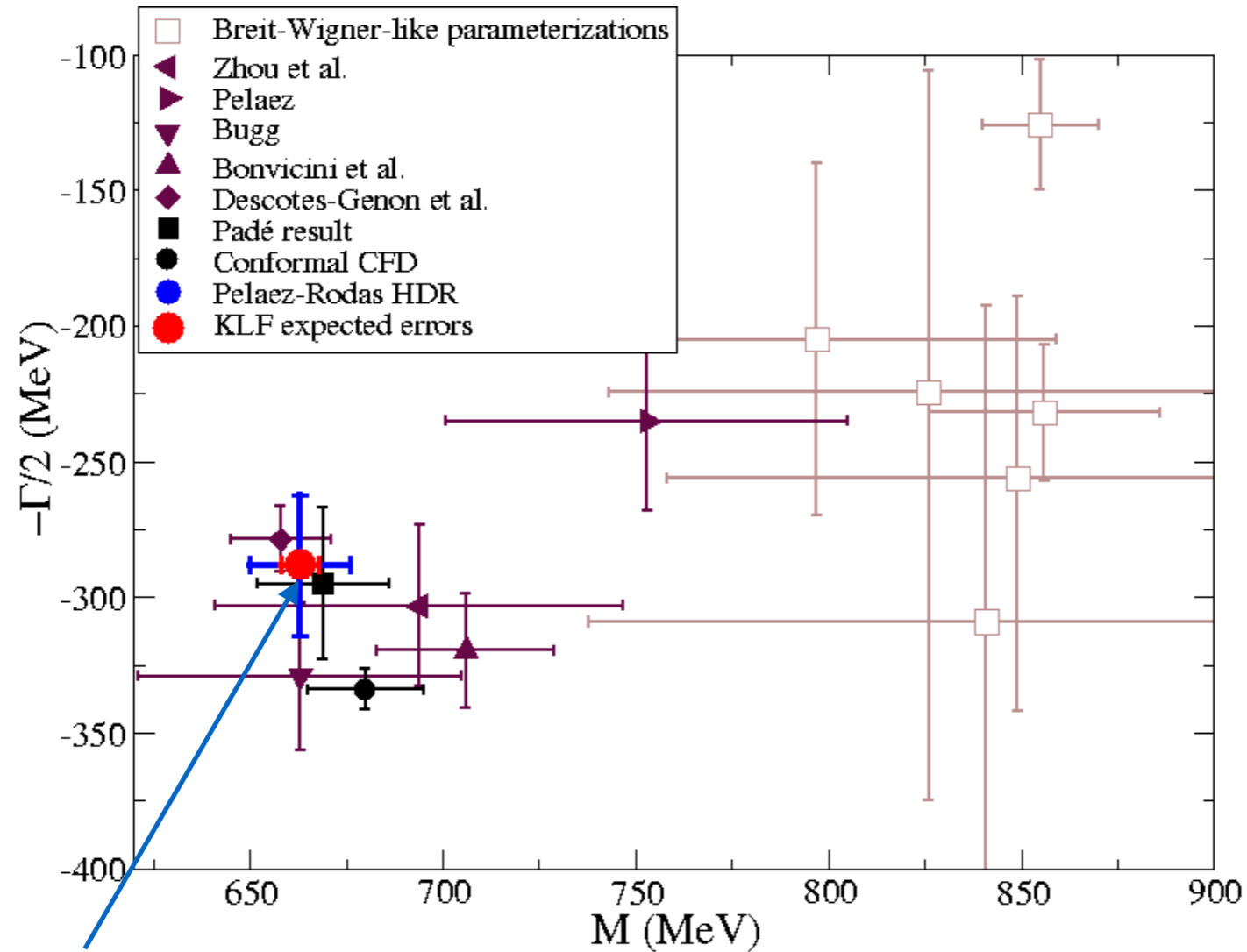

100 days of running

**Measurement with KLF will reduce:
Uncertainty in the mass by factor of two
Uncertainty in the width by factor of five!**

Summary of $K\pi$ Scattering

- The KLF will have a very significant impact on our knowledge on $K\pi$ scattering amplitudes
- It will certainly improve still conflictive determination of heavy K^* 's parameters
- It will help to settle the tension between phenomenological determinations of scattering lengths from data versus ChPT and LQCD
- Finally, and very importantly, it will reduce by more than a **factor of two** the **uncertainty in the mass determination of $K^*(800)$** and by **factor of five** the **uncertainty on its width**, and therefore **on its coupling**
- It will help to clarify debates of **its existence**, and therefore a long standing problem of **existence of the scalar meson nonet**

Evolution of an Early Universe at Freeze-out

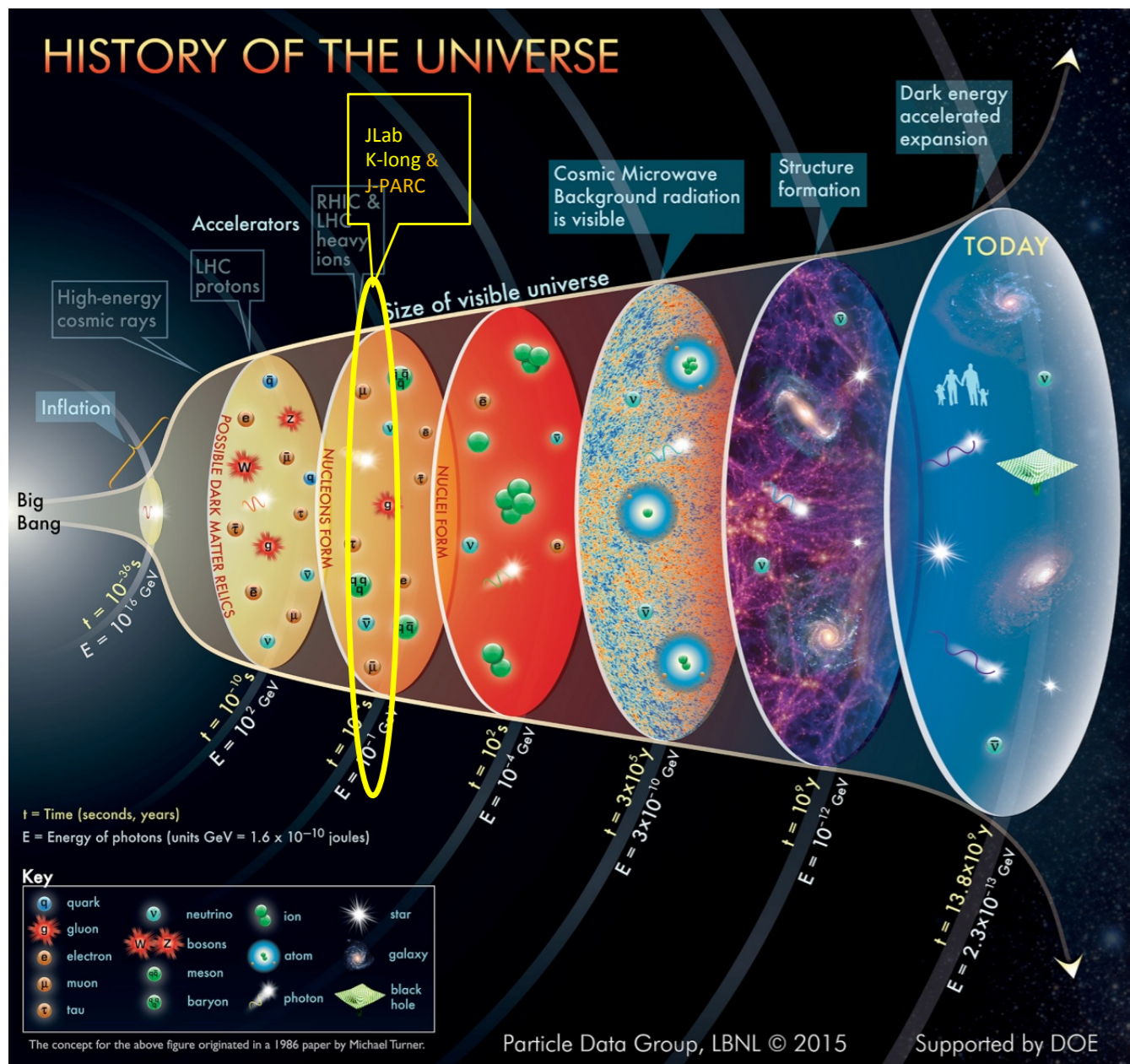

Chemical potential

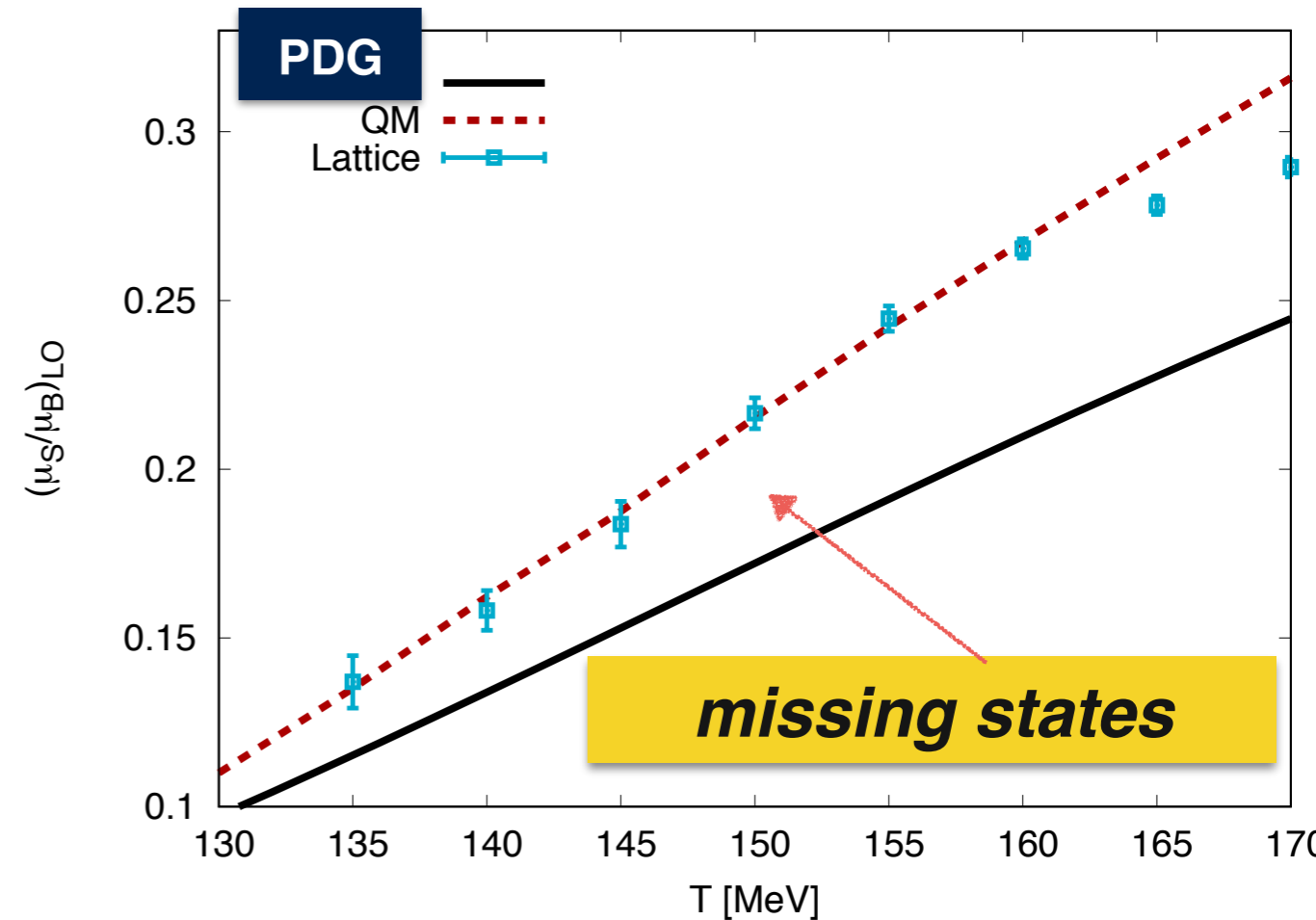

YSTAR2016 Proceedings arXiv:
1701.07346

KL Project will shed a light on thermodynamic properties of EU $1\mu s$ after the Big Bang

The main part of deficit is due to missing hyperon states

Hall-D beamline and GlueX Setup

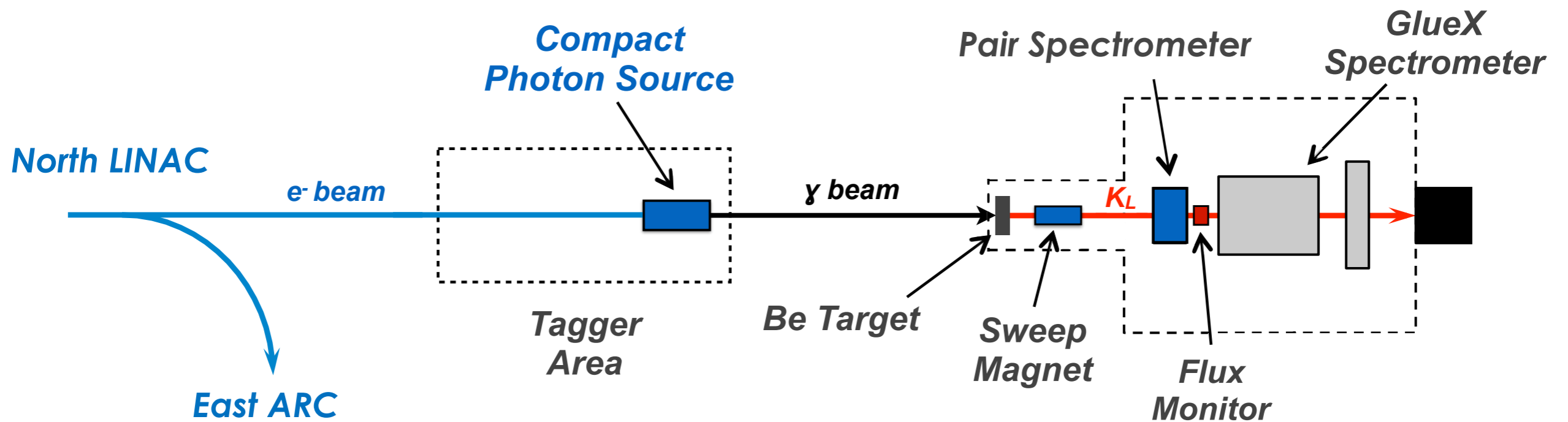

Electron Beam Parameters

$$E_e = 12 \text{ GeV} \quad I = 5 \mu\text{A}$$

$$\text{Bunch spacing} \quad 64 \text{ ns}$$

No major problems.

Doable !

Confirmed by accelerator experts

Compact Photon Source

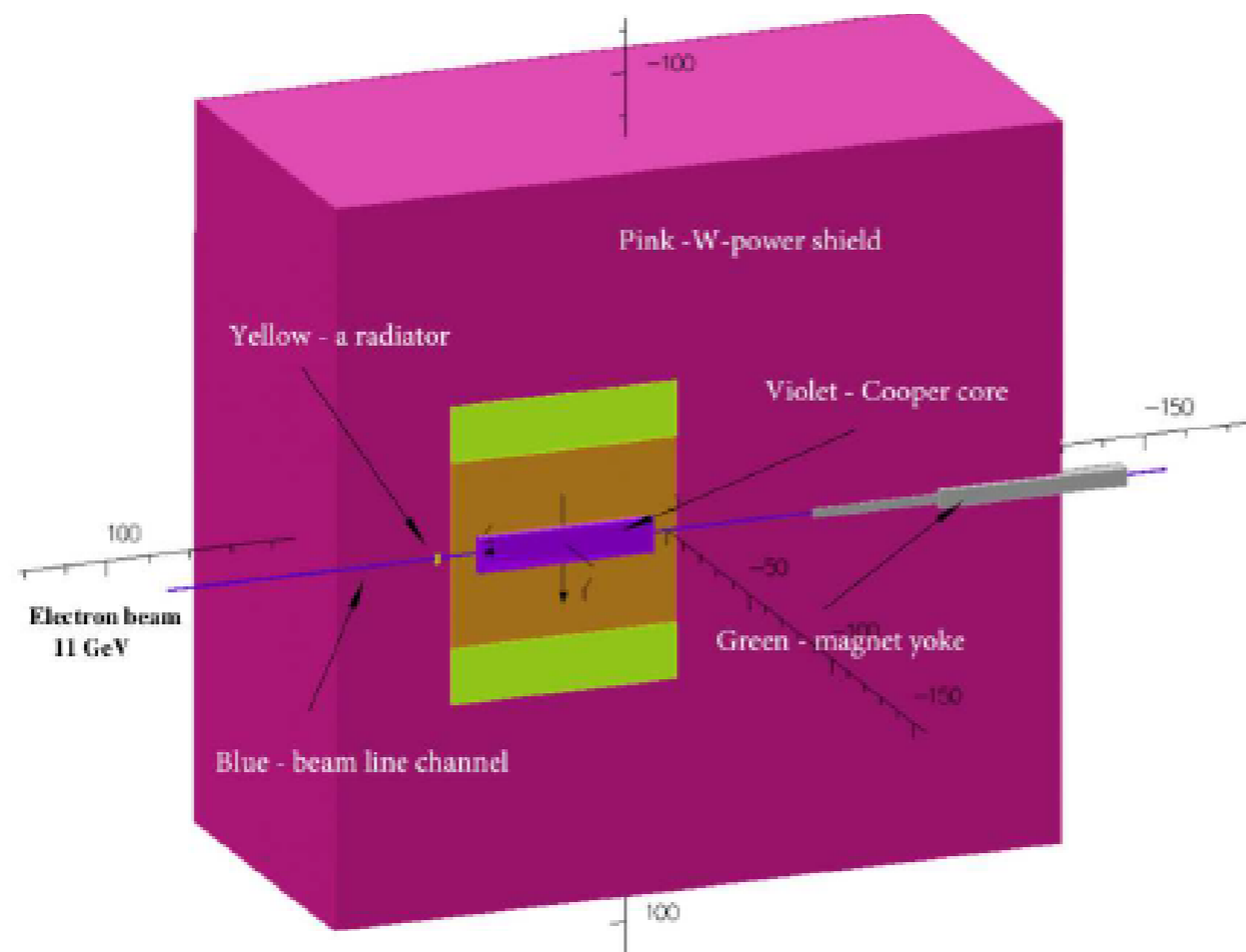

Conceptual design is completed for Halls A&C

The details of the CPS are designed by the CPS Collaboration

Meets RadCon Radiation Requirements

Be Target Assembly: Conceptual Design

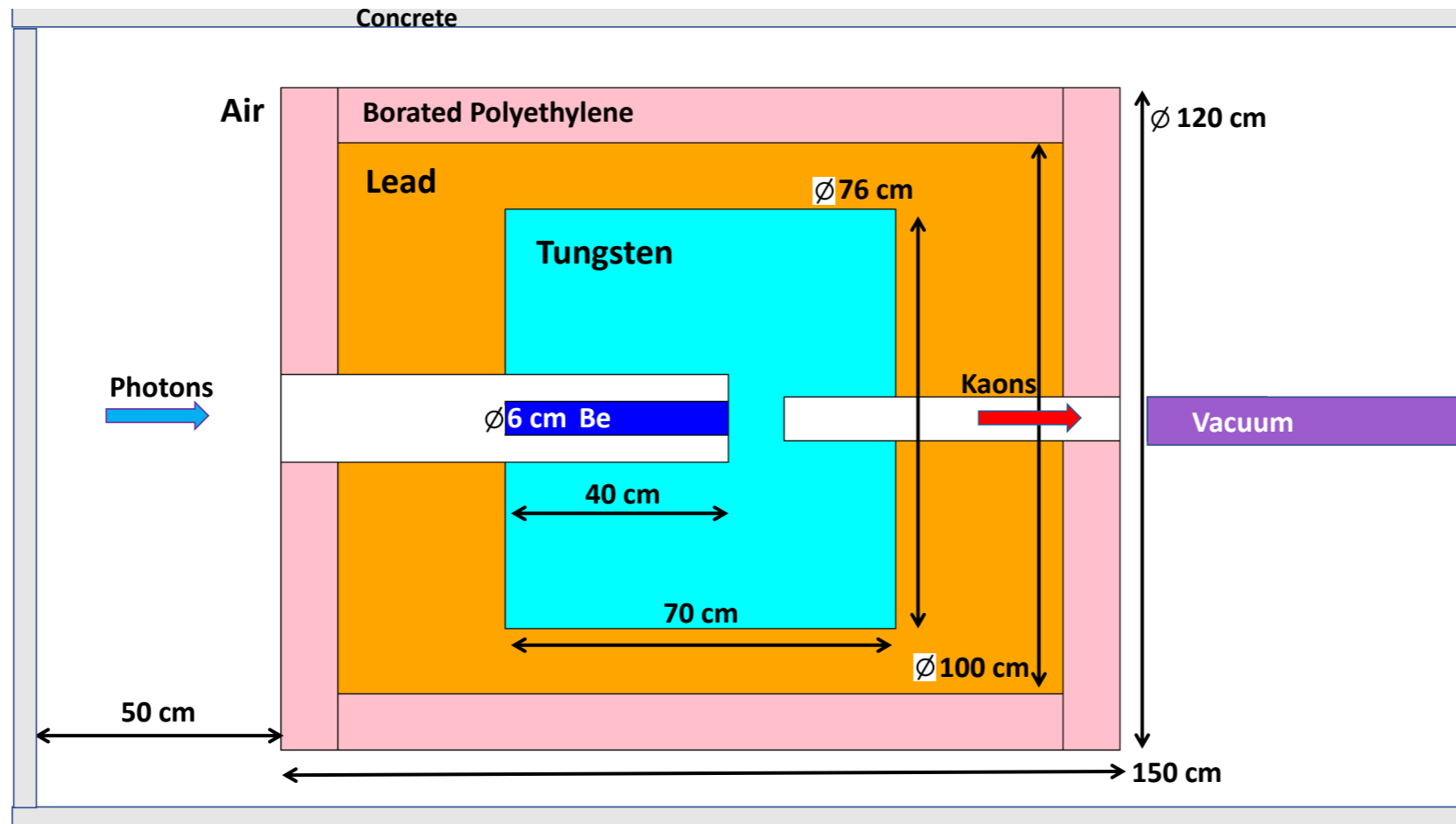

-Meets RadCon Radiation Requirements

-Conceptual Design Endorsed by Hall-D Engineering Staff

Flux Monitor

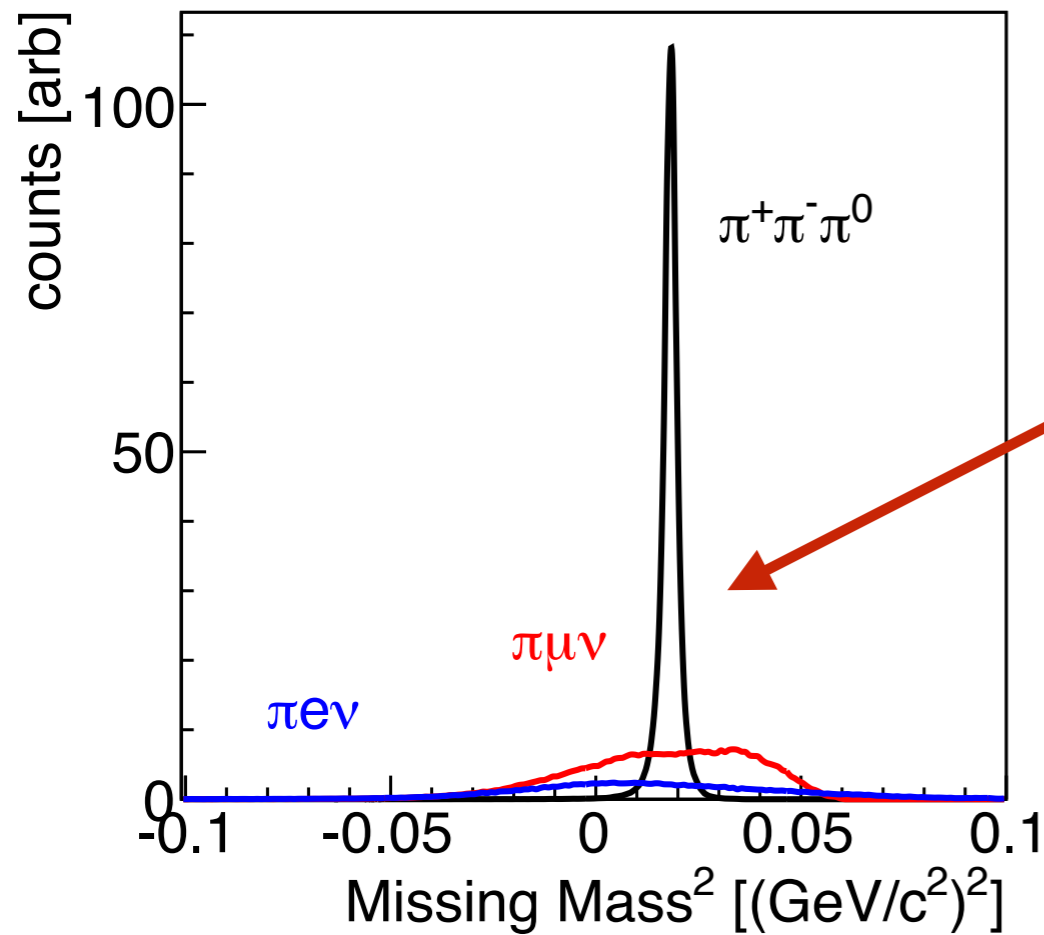
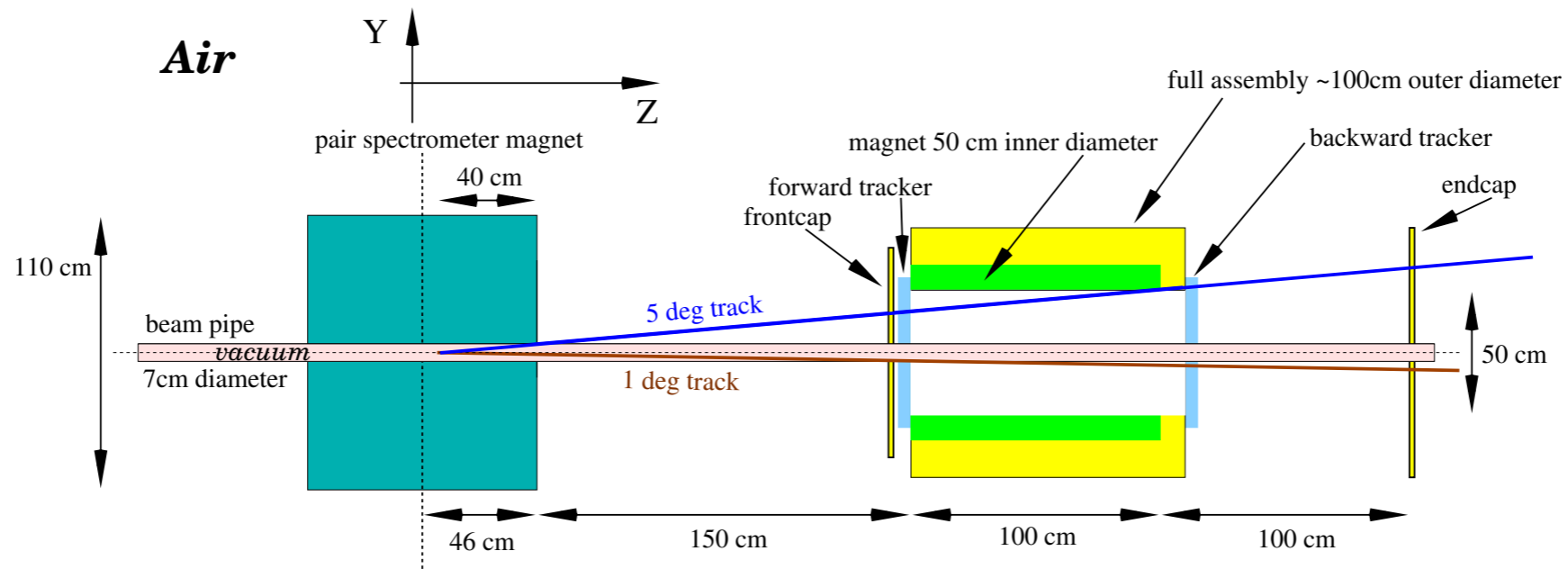

Reconstructed K_L

via missing (π^0)

Flux measurement stat. err. <1%

Estimated syst. err. ~5%

K_L Beam Flux

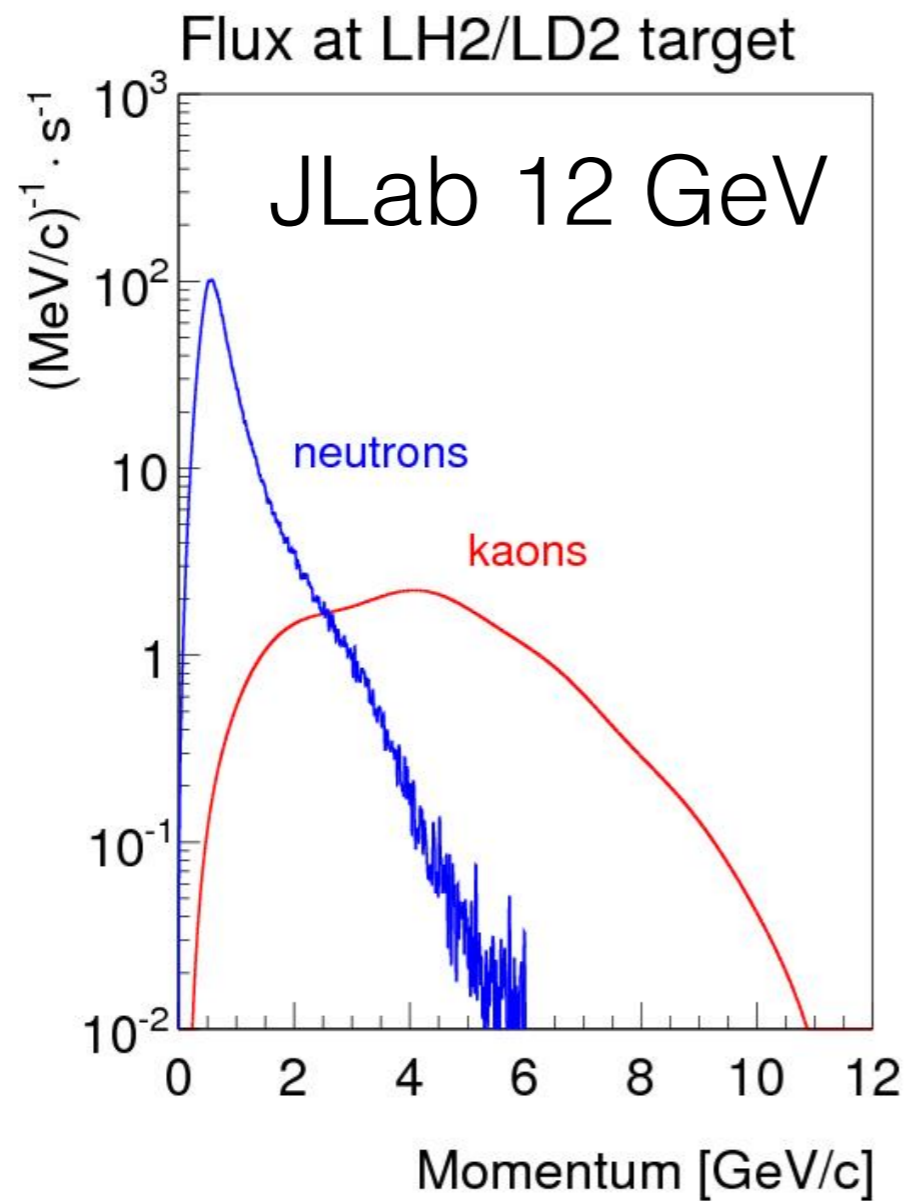

$$N(K_L)/sec \sim 10^4$$

SLAC 16 GeV

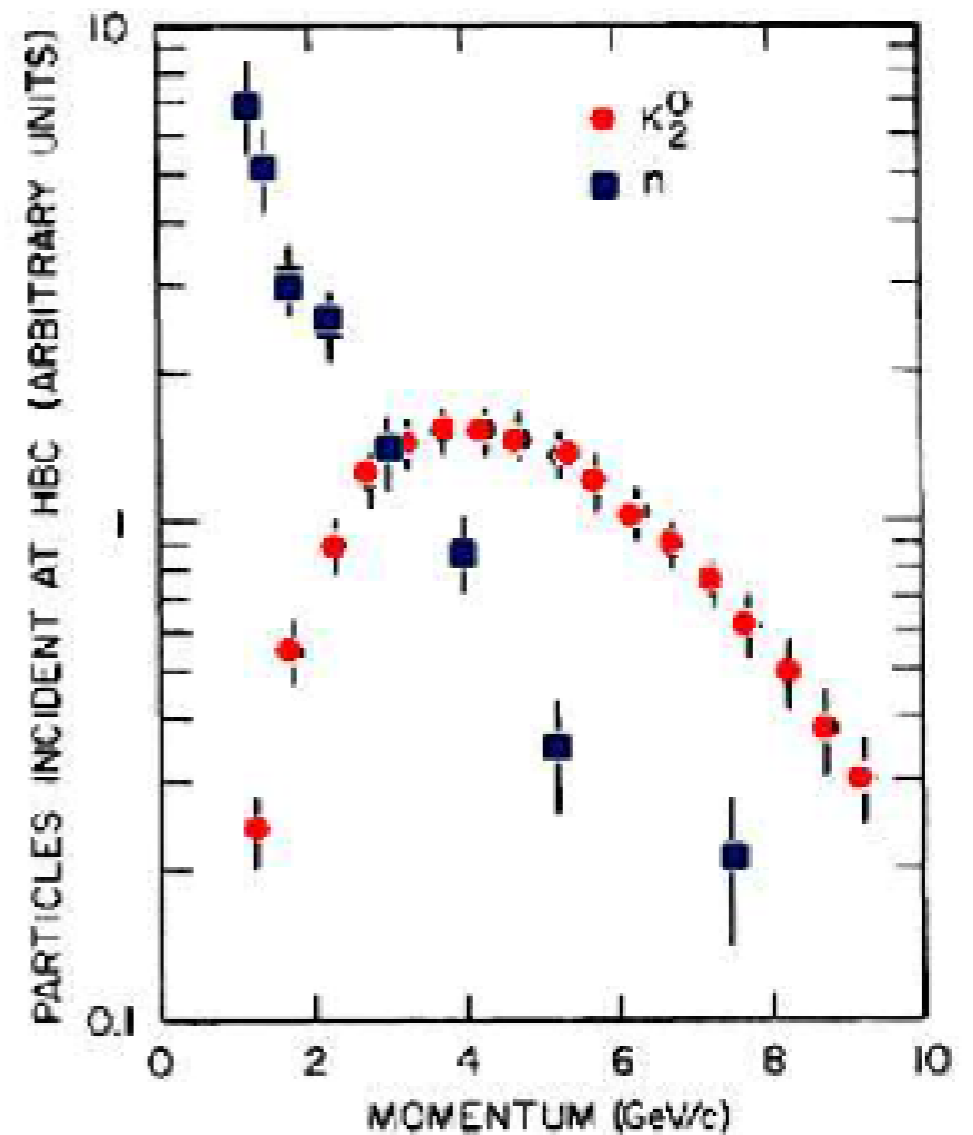

$$\frac{N(K_L)_{JLAB}}{N(K_L)_{SLAC}} \sim 10^3$$

LH₂/LD₂ Cryogenic Target for Neutral Kaon Beam at Hall D

The GlueX liquid hydrogen target.

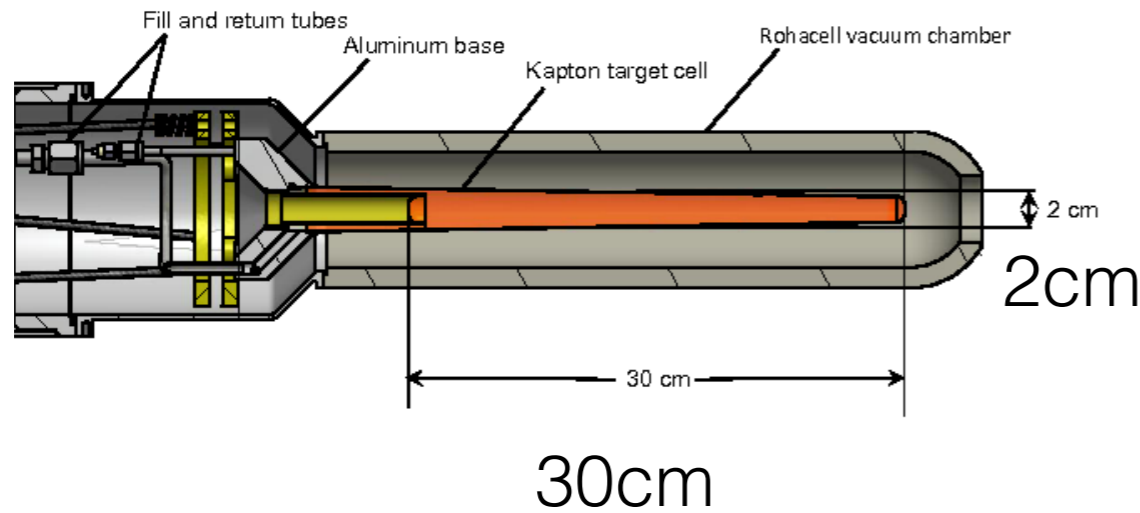

Current

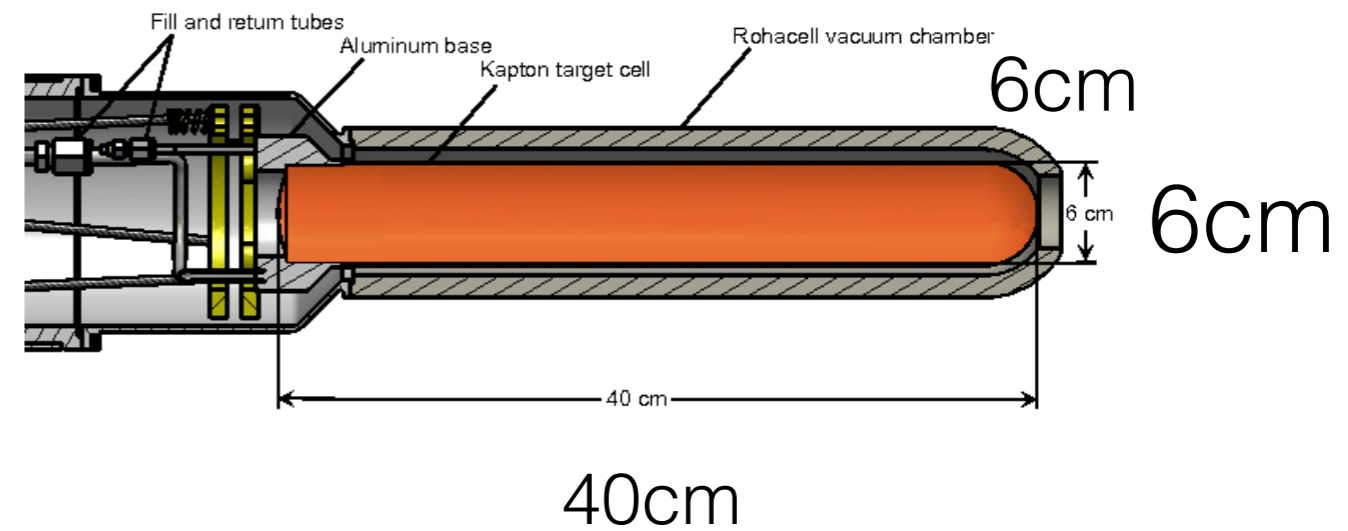

Proposed & Feasible

Longer and thicker target is needed to enhance production rate

Conceptual design has been endorsed by the JLAB target group

PHYSICS WITH NEUTRAL KAON BEAM AT JLAB
KL2016

FEBRUARY 1-3, 2016
JEFFERSON LAB
NEWPORT NEWS, VIRGINIA

SCOPE

The Workshop is following Lo112-15-001 "Physics Opportunities with Secondary KL beam at JLab" and will be dedicated to the physics of hyperons produced by the kaon beam on unpolarized and polarized targets with GlueX set up in Hall D. The emphasis will be on the hyperon spectroscopy. Such studies could contribute to the existing scientific program on hadron spectroscopy at Jefferson Lab.

The Workshop will also aim at boosting the international collaboration, in particular between the US and EU research institutions and universities.

The Workshop would help to address the comments made by the PAC43, and to prepare the full proposal for the next PAC44.

ORGANIZING COMMITTEE

Moskov Amaryan, ODU, chair
Eugene Chudakov, JLab
Curtis Meyer, CMU
Michael Pennington, JLab
James Ritman, Ruhr-Uni-Bochum & IKP Jülich
Igor Strakovsky, GWU

WWW.JLAB.ORG/CONFERENCES/KL2016



YSTAR
Excited Hyperons in QCD
Thermodynamics at Freeze-Out **2016**

NOVEMBER 16-17, 2016

Jefferson Lab
Newport News, Virginia

A workshop to discuss the influence of possible "missing" hyperon resonances (JLab KLF Project) on QCD thermodynamics, on freeze-out in heavy ion collisions and in the early universe, and in spectroscopy. Recent studies that compare lattice QCD calculations of thermodynamic calculations, statistical hadron resonance gas models, and ratios between measured yields of different hadron species in heavy ion collisions provide indirect evidence for the presence of "missing" resonances in all of these contexts. The aim of the workshop is to sharpen these comparisons, advance our understanding of the formation of baryons from quarks and gluons microseconds after the Big Bang and in today's experiments, and to connect these developments to experimental searches for direct, spectroscopic, evidence for these resonances. This Workshop is a successor to the recent KL2016 Workshop

ORGANIZING COMMITTEE

Moskov Amaryan - Chair
ODU
Eugene Chudakov
JLab
Krishna Rajagopal
MIT
Claudia Ratti
University of Houston
James Ritman, Ruhr
U. Bochum & IKP Jülich
Igor Strakovsky
GWU



WWW.JLAB.ORG/CONFERENCES/YSTAR2016/



HIPS 2017

New Opportunities with High-Intensity Photon Sources

February 6-7, 2017
Catholic University of America
Washington, DC U.S.A.

This workshop aims at producing an optimized photon source concept with potential increase of scientific output at Jefferson Lab, and at refining the science for hadron physics experiments benefiting from such a high-intensity photon source. The workshop is dedicated to bringing together the communities directly using such sources for photo-production experiments, or for conversion into K_s beams. The combination of high precision calorimetry and high intensity photon sources can provide greatly enhanced scientific benefit to (deep) exclusive processes like wide-angle and time-like Compton scattering. Potential prospects of such a high-intensity source with modern polarized targets will also be discussed. The availability of K_s beams would open new avenues for hadron spectroscopy, for example for the investigations of "missing" hyperon resonances, with potential impact on QCD thermodynamics and on freeze-out both in heavy ion collisions and the early universe.

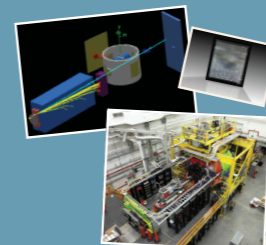

Organizing Committee:

Taule Horn - CUA
Cynthia Keppel - JLab
Carlos Munoz-Camacho - IPNO
Igor Strakovsky - GWU



π-K Interactions
Workshop

ORGANIZING COMMITTEE

Moskov Amaryan, ODU (Chair)
U.-G. Meissner, U. Bonn/IKP Jülich
Curtis Meyer, CMU
James Ritman, Ruhr-Uni-Bochum/IKP Jülich
Igor Strakovsky, GWU

February 14-15, 2018
Jefferson Lab • Newport News, VA

The π-K scattering enables direct investigations of scalar and vector K* states, including the not yet established S-wave K(800) state. These studies are also needed to get precise values of vector and scalar form factors: to independently extract CKM matrix element V_{us} and to test the Standard Model unitarity relation in the first row of CKM matrix, to study CP violation from the Dalitz plot analysis of open charm D meson decays and in a charmless decays of B mesons in Kpiπ final states. Significant progress is made lately in Lattice QCD, in the phenomenology and in the Chiral Perturbation Theory to describe different aspects of π-K scattering. The main source of experimental data is based on experiments performed in SLAC almost five decades ago at 1970-80s. The recently proposed KL Facility incorporating the GlueX spectrometer at JLab will be able to improve the π-K scattering database by about three orders of magnitude in statistics. The workshop will discuss the necessity for and the impact of the future high statistics data obtained at JLab on π-K scattering.

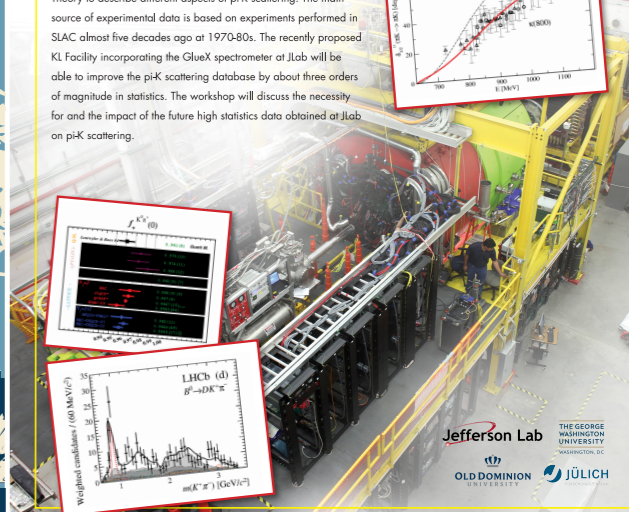
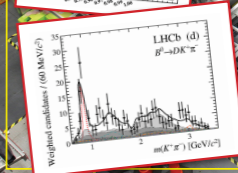
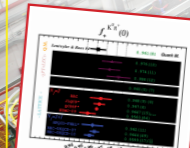
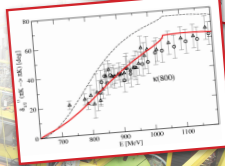
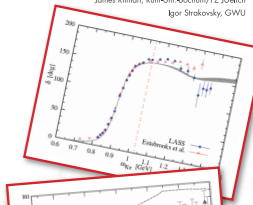

<https://www.jlab.org/conferences/pki2018/>

KL2016

[60 people from 10 countries, 30 talks] <https://www.jlab.org/conferences/kl2016/>
OC: M. Amaryan, E. Chudakov, C. Meyer, M. Pennington, J. Ritman, & I. Strakovsky

YSTAR2016

[71 people from 11 countries, 27 talks] <https://www.jlab.org/conferences/YSTAR2016/>
OC: M. Amaryan, E. Chudakov, K. Rajagopal, C. Ratti, J. Ritman, & I. Strakovsky

HIPS2017

[43 people from 4 countries, 19 talks] <https://www.jlab.org/conferences/HIPS2017/>
OC: T. Horn, C. Keppel, C. Munoz-Camacho, & I. Strakovsky

PKI2018

[48 people from 9 countries, 27 talks] <http://www.jlab.org/conferences/pki2018/>
OC: M. Amaryan, U.-G. Meissner, C. Meyer, J. Ritman, & I. Strakovsky

In total: 222 participants & 103 talks

SUMMARY

- -Proposed KL Facility has a unique capability to improve existing world database up to three orders of magnitude
- -In Hyperon spectroscopy
PWA will allow to unravel and measure pole positions and widths of dozens of new excited hyperon states
- -In Strange Meson Spectroscopy
PWA will allow to measure excited K^* states including scalar K
- KLF Project will have a strong impact on
-Thermodynamics of an Early Universe

Summary: ***From TAC Report***

Feasibility: The project appears to be technically feasible. The cost (without local labor) was estimated at about \$6M (taking into account the recent CPS estimate), including about \$1M for the Flux Monitor, which may become a foreign contribution.

Thank you !

Backup Slides

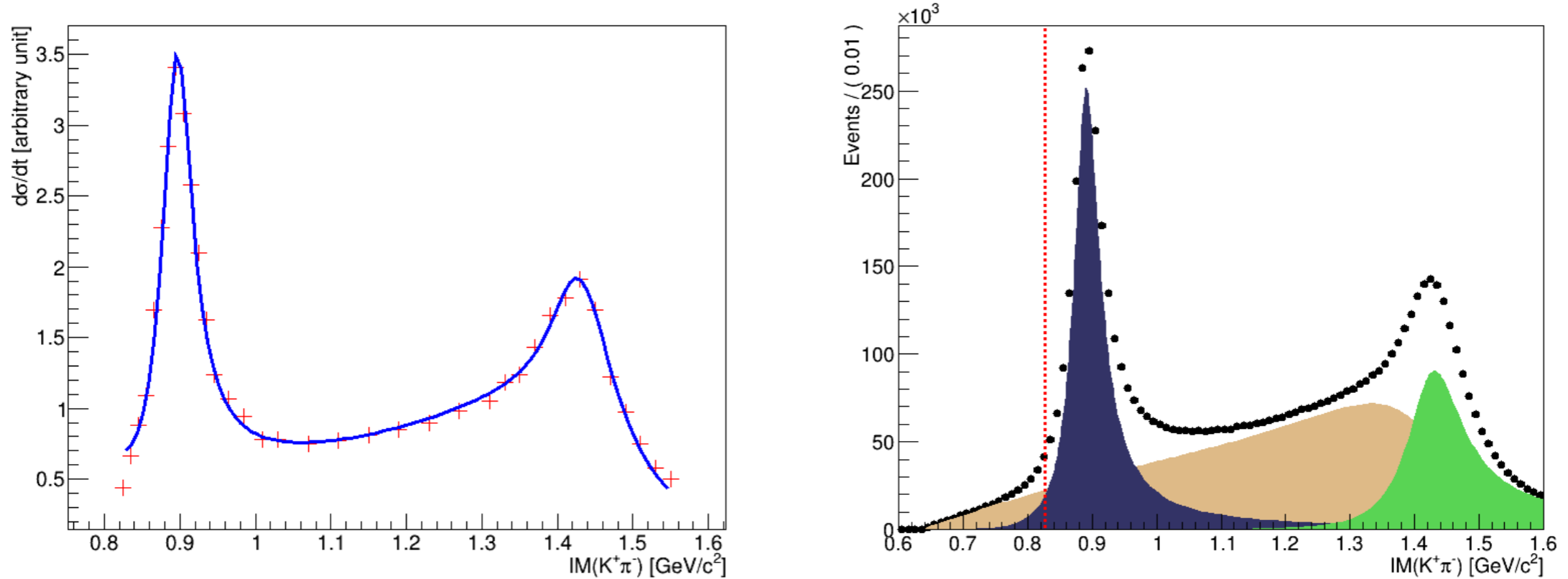

Figure 28: Left panel: Cross section of $K^-p \rightarrow K^+\pi^-n$ as a function of the invariant mass from LASS results [122]. The blue line is the fit to the cross section using composite model containing two RBW, spin-1 and spin-2, and S -wave LASS parameterization. Right panel: Expected distribution of the $K^+\pi^-$ invariant mass below 1.6 GeV from KLF after 100 days of run. The dark blue function represents the $K^+\pi^-$ P -wave, light brown the S -wave and green the D -wave. The dashed line represents the threshold of $K\pi$ invariant mass in LASS results [122].

