

The Quest for Strange resonances at KLF

Arkaitz Rodas

REACHING FOR THE HORIZON



The Site of the Wright Brothers' First Airplane Flight

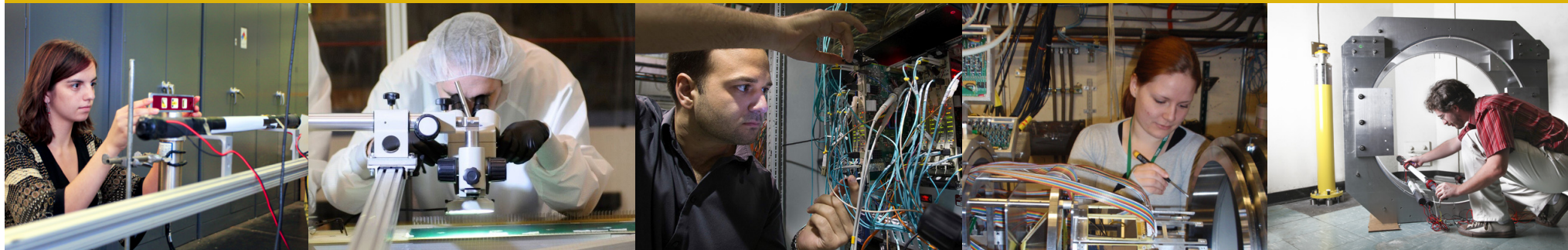

The 2015
LONG RANGE PLAN
for NUCLEAR SCIENCE



“... hadron spectroscopy illuminates the QCD interaction that binds quarks.”

QCD

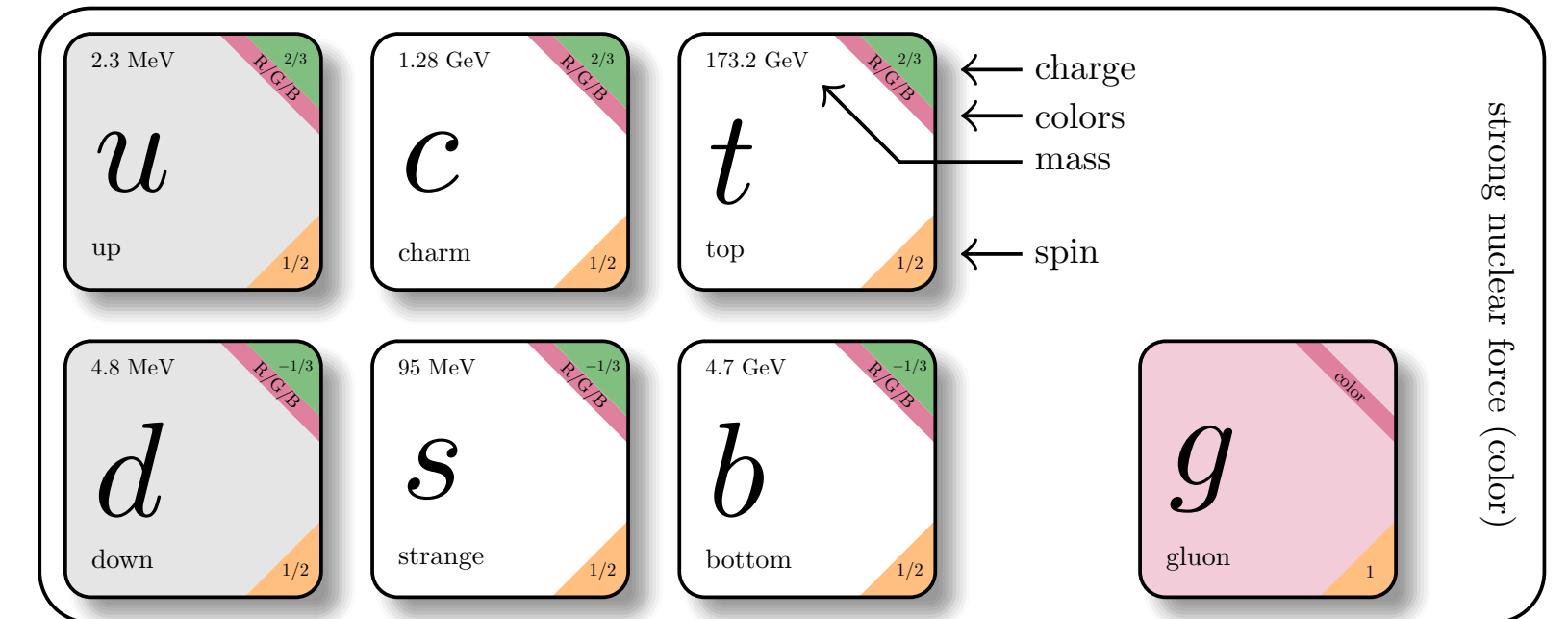

Understanding

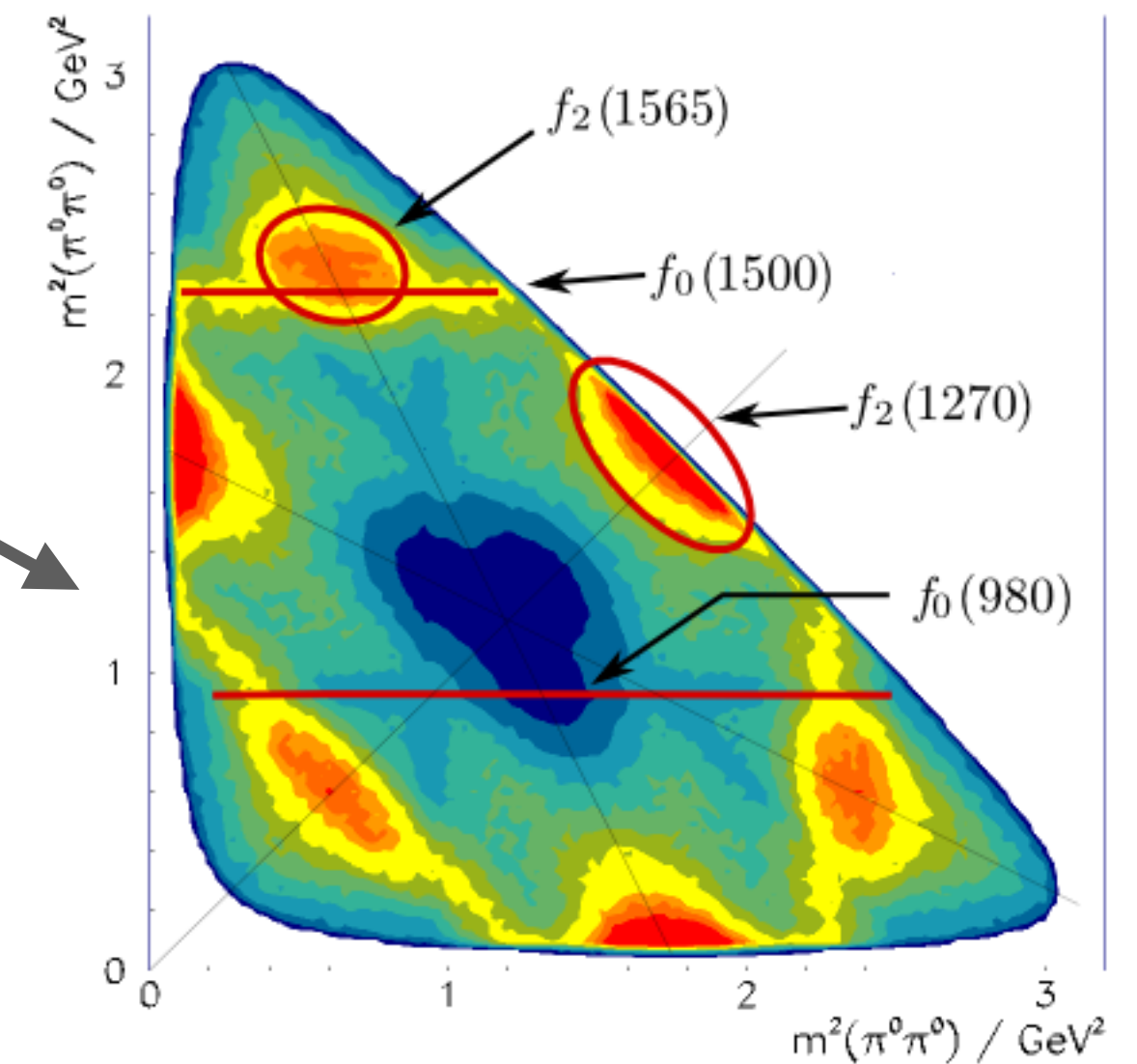

Strange K^* resonances: PDG

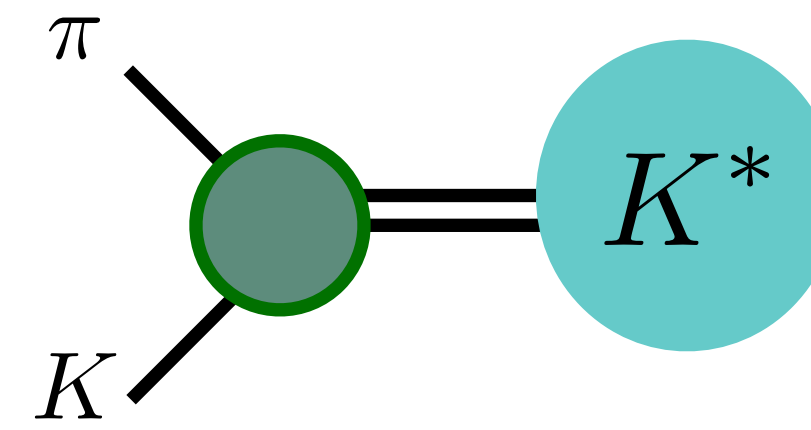

The fiercely debated
JRP talk

$K^*(0)(700)$	PDF	pdgLive
$K^*(892)$	PDF	pdgLive
$K^*(1410)$	PDF	pdgLive
$K^*(0)(1430)$	PDF	pdgLive
$K^*(2)(1430)$	PDF	pdgLive
$K^*(1680)$	PDF	pdgLive
$K^*(3)(1780)$	PDF	pdgLive
$K^*(0)(1950)$	PDF	pdgLive
$K^*(2)(1980)$	PDF	pdgLive
$K^*(4)(2045)$	PDF	pdgLive

10 total states

We will stop here

Why can't we go further?

Strange K^* resonances: PDG

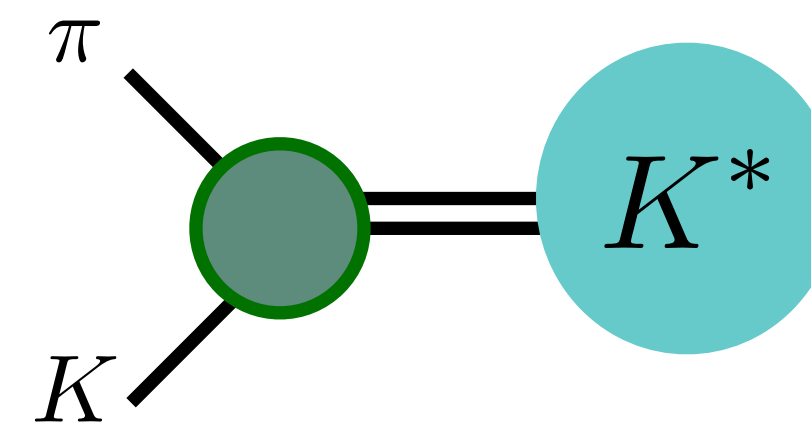

The fiercely debated

JRP talk

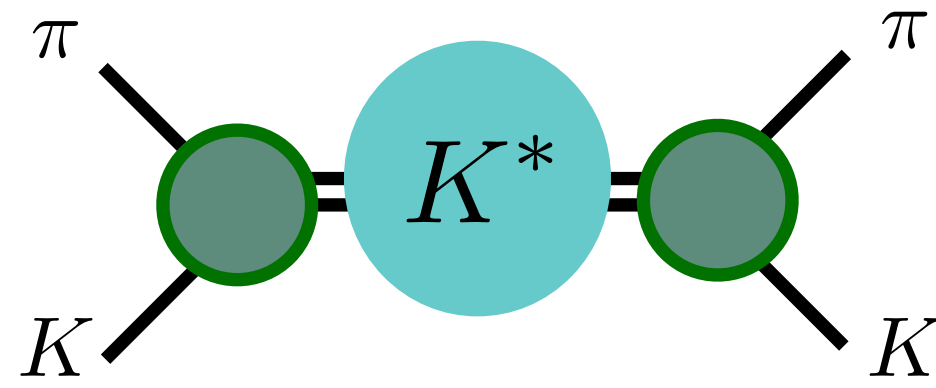

+ Other FSI

$K^*(0)(700)$	PDF	pdgLive
$K^*(892)$	PDF	pdgLive
$K^*(1410)$	PDF	pdgLive
$K^*(0)(1430)$	PDF	pdgLive
$K^*(2)(1430)$	PDF	pdgLive
$K^*(1680)$	PDF	pdgLive
$K^*(3)(1780)$	PDF	pdgLive
$K^*(0)(1950)$	PDF	pdgLive
$K^*(2)(1980)$	PDF	pdgLive
$K^*(4)(2045)$	PDF	pdgLive

10 total states

We will stop here

Why can't we go further?

What can we help with?

JRP talk

Heavier K^* are poorly known

Different production mechanisms lead to not very consistent results

Scattering should provide a clean extraction of these states

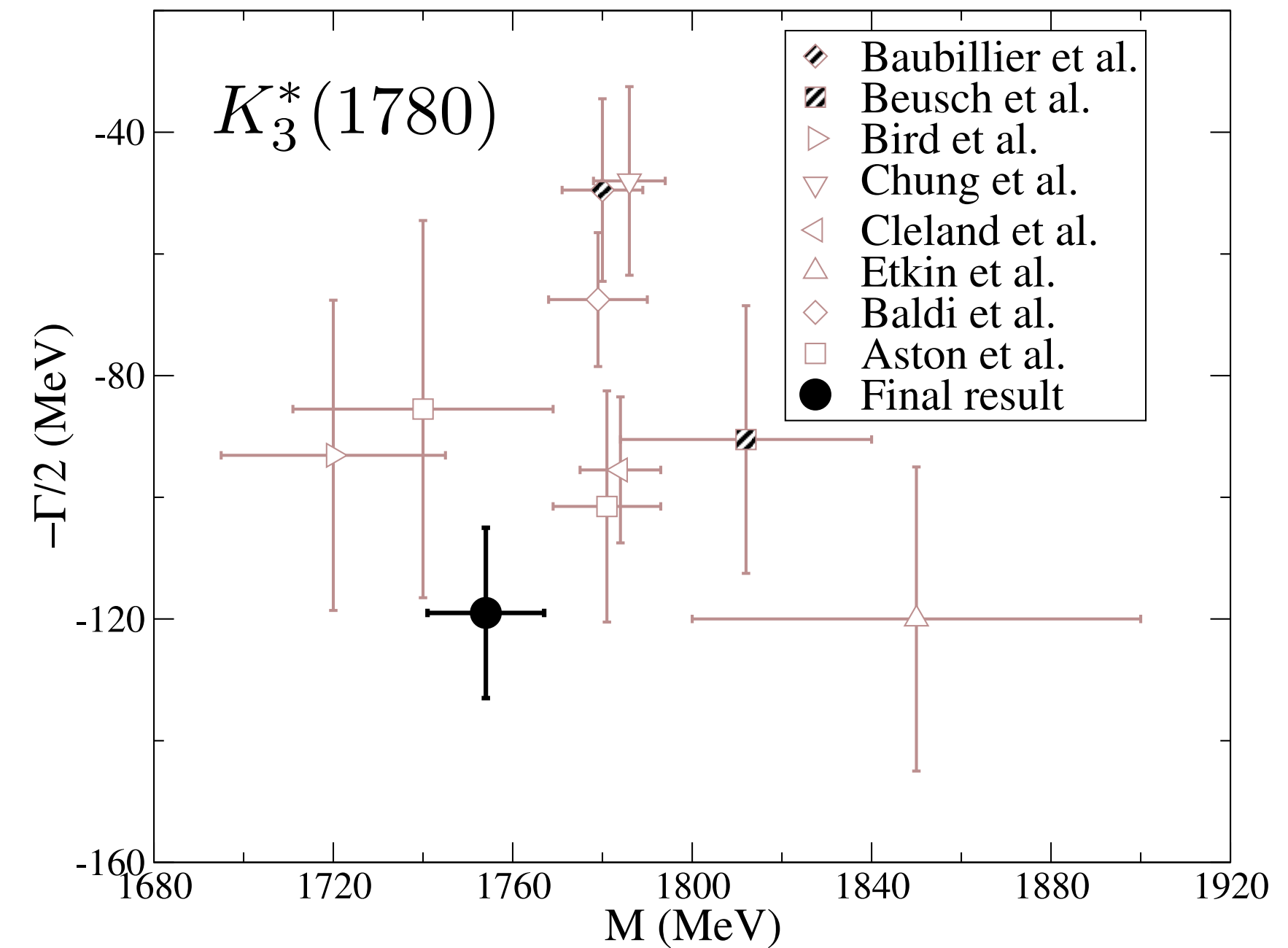
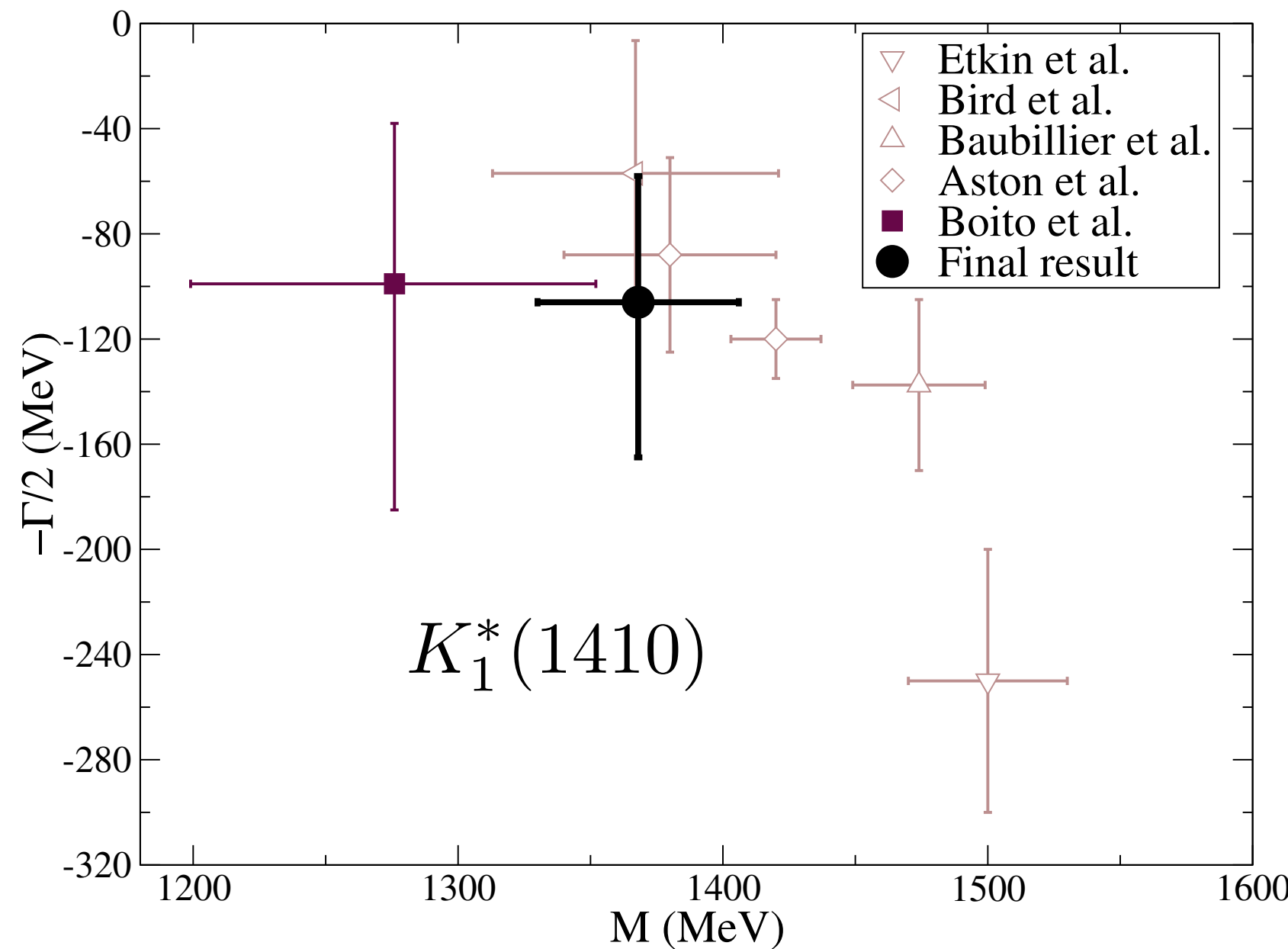
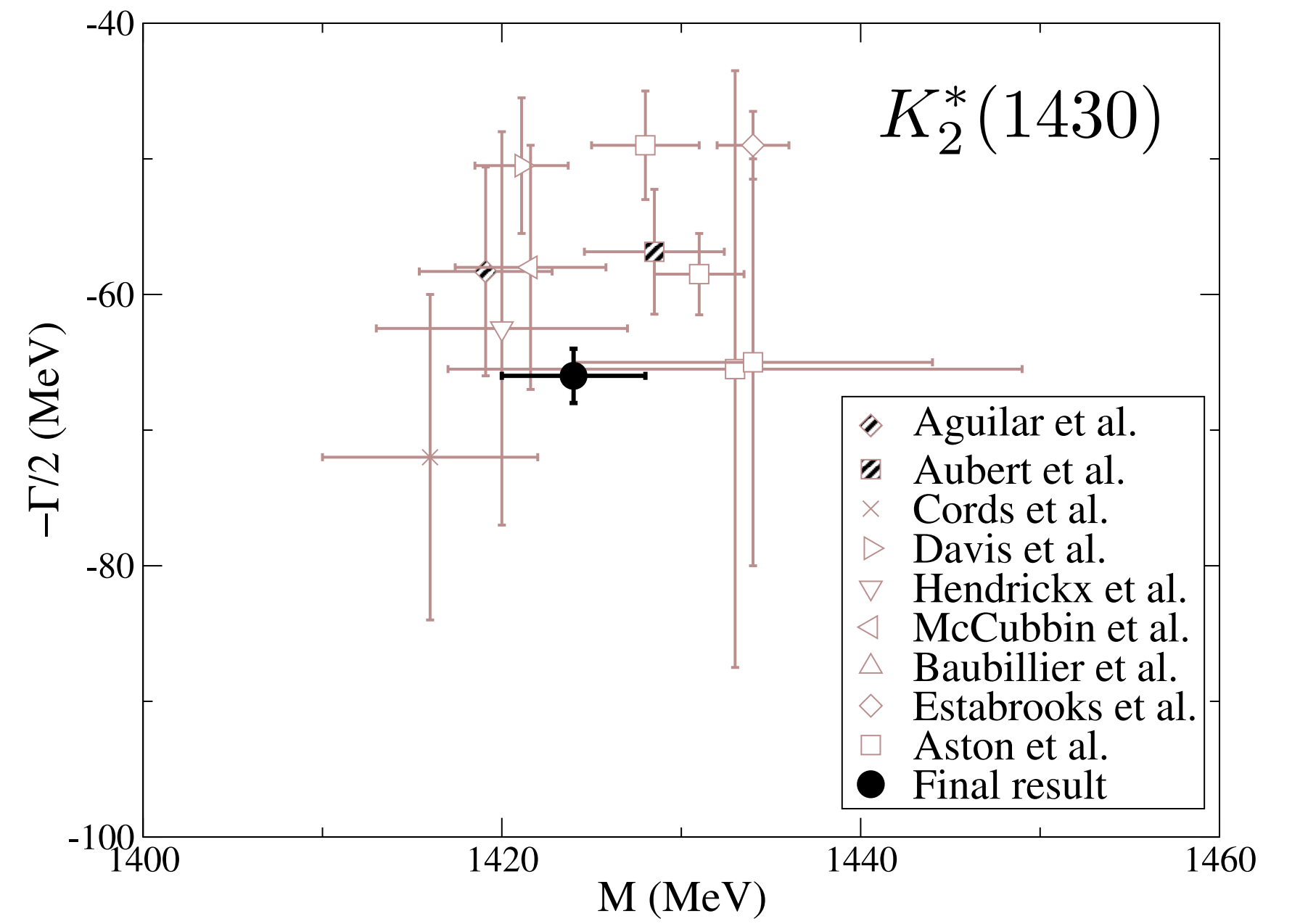
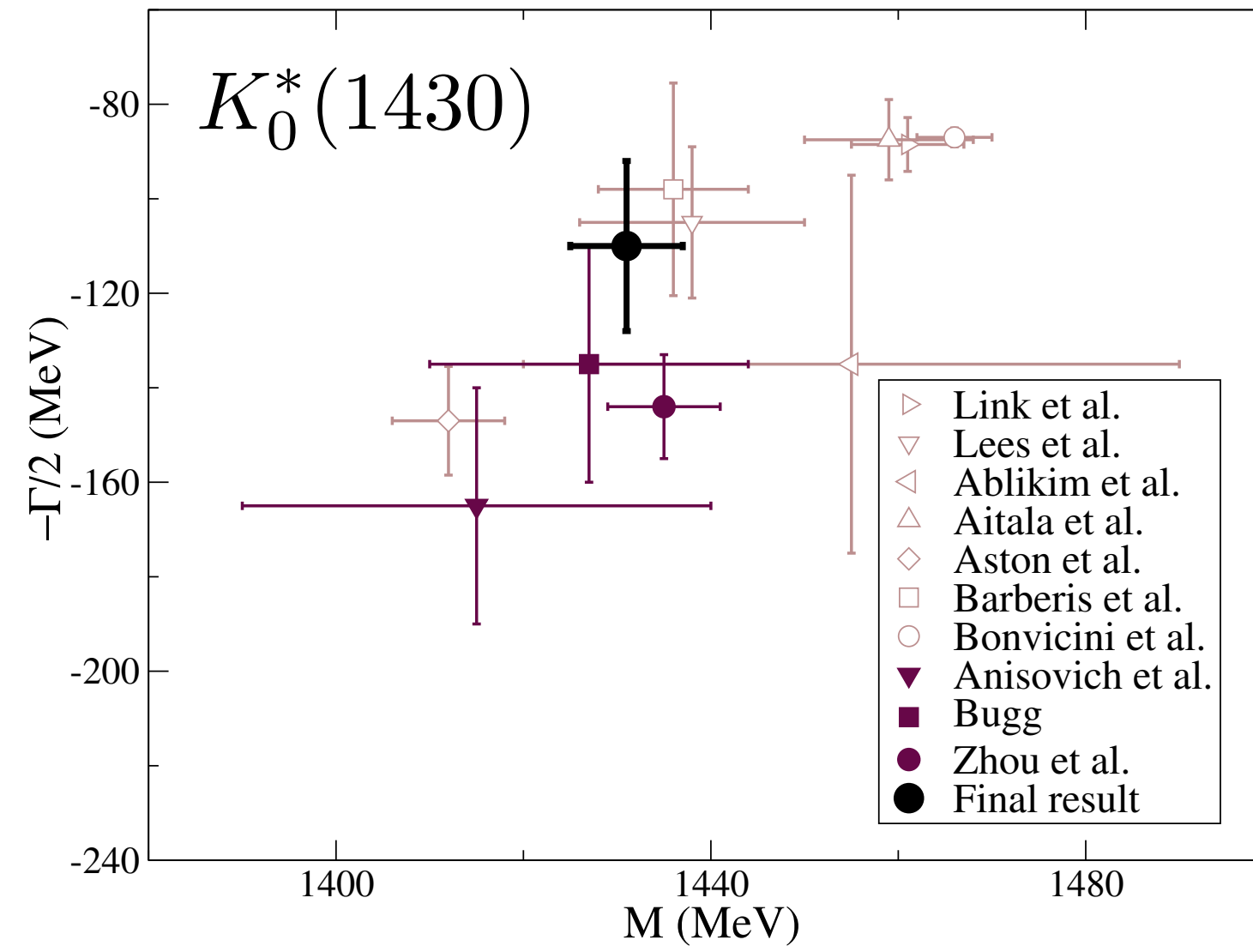

What can we help with?

JRP talk

K_0^*

Second lightest resonance

Extremely broad \rightarrow extremely short-lived

Correlated with chiral symmetry-breaking phenomena

Not well-understood \rightarrow new observables ??

Input to hadron physics observables

$$B \rightarrow K\pi$$

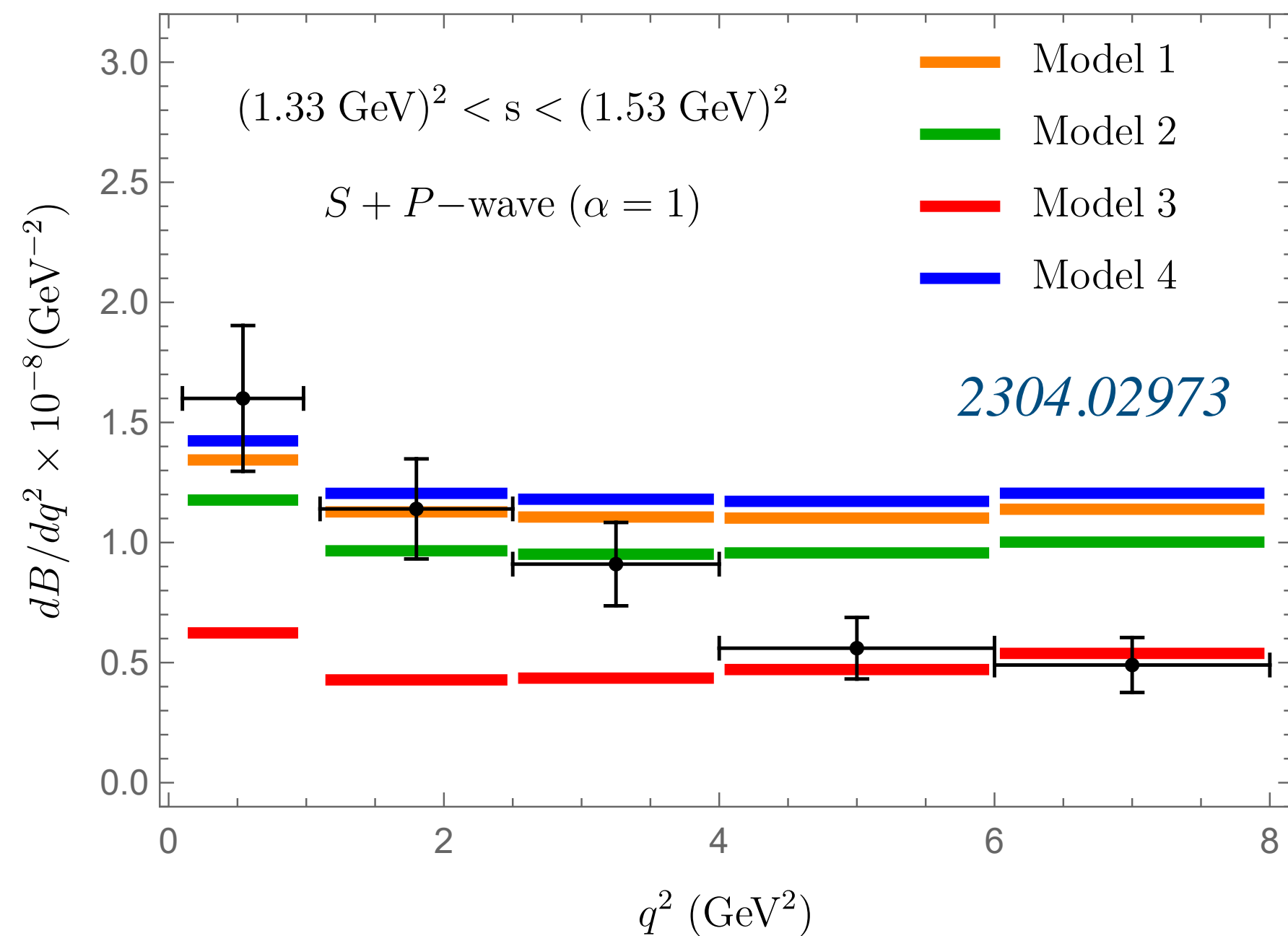

K^*

K_0^*

$$B \rightarrow K^* \ell \ell$$

1903.09578

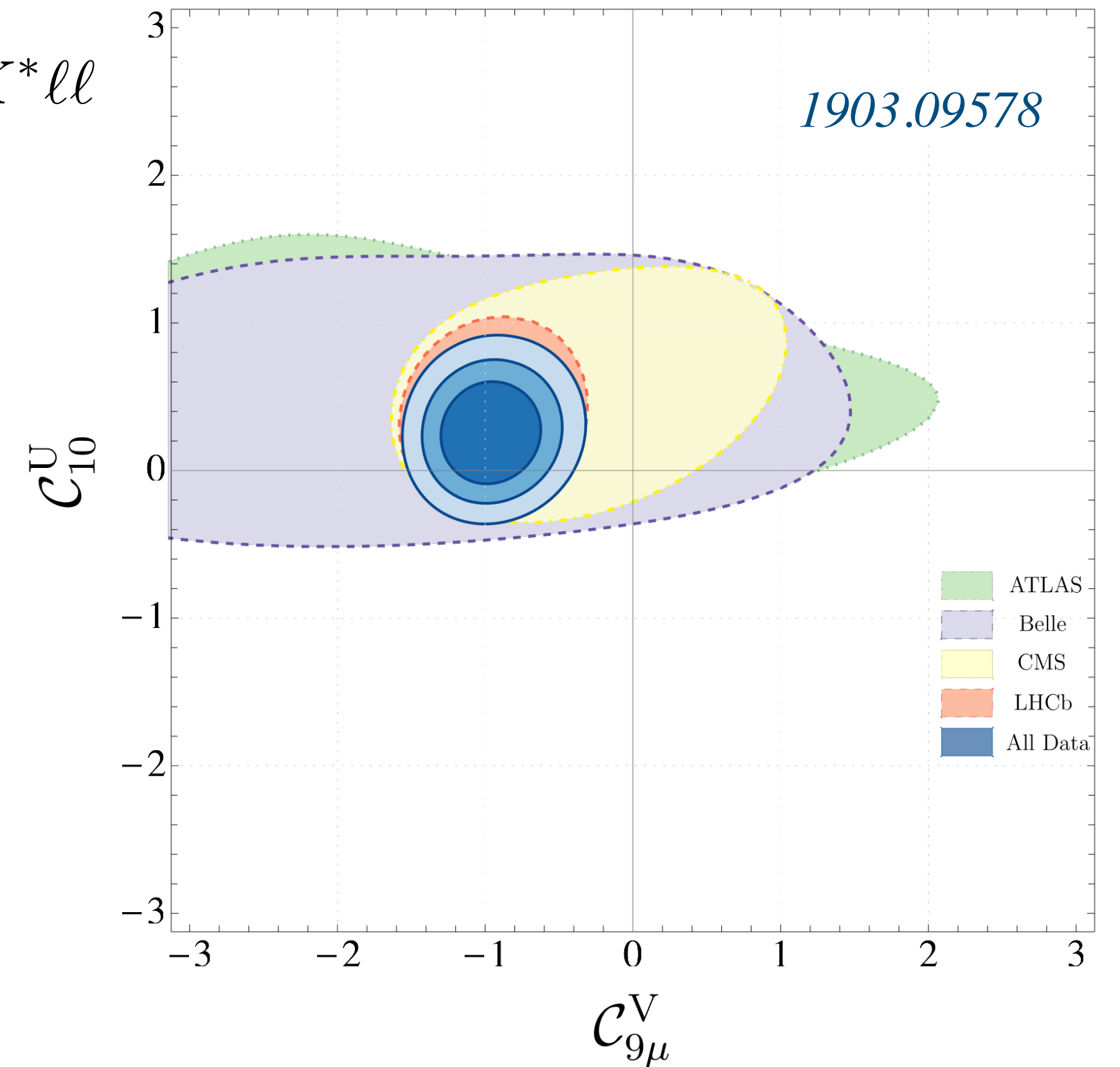

Other applications?

Not even the narrow $K^*(892)$ is so well known

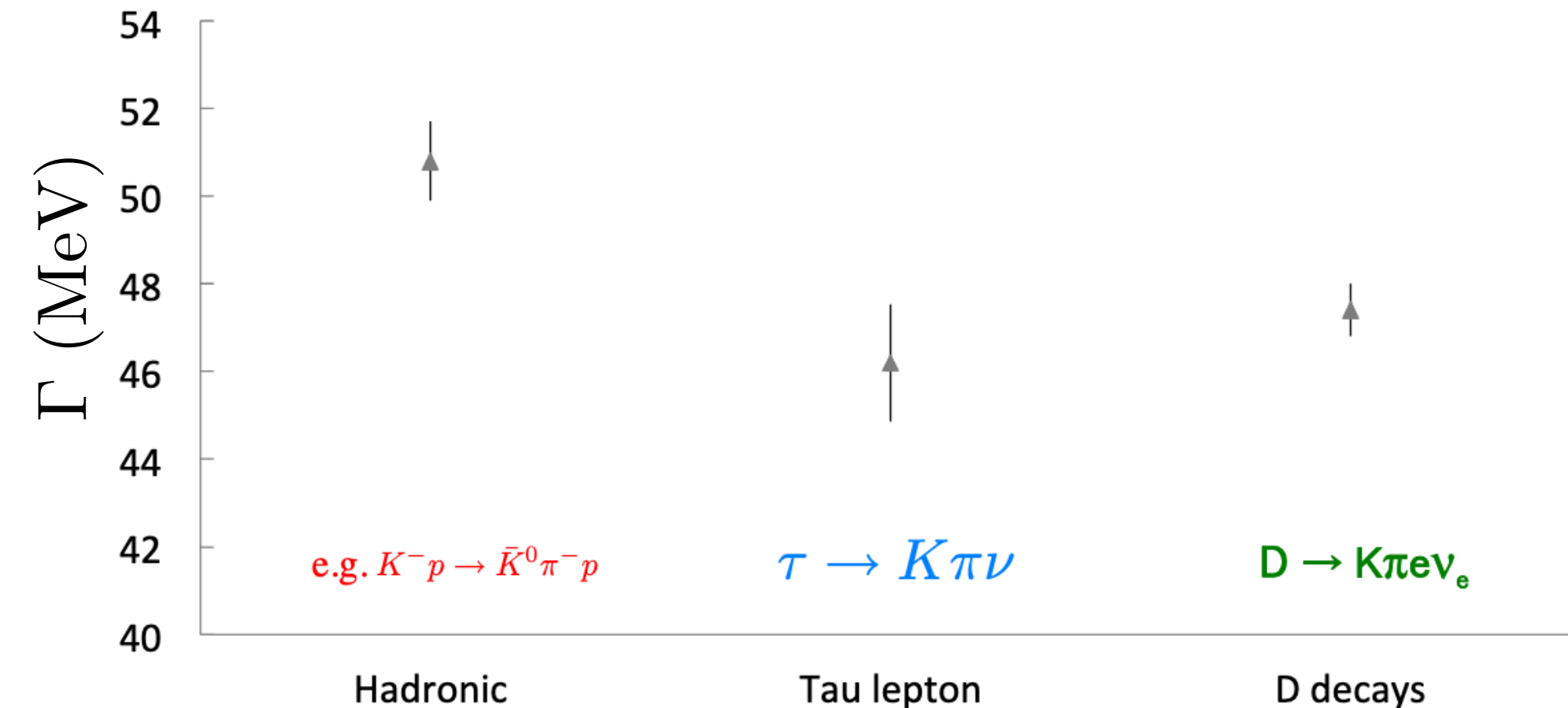
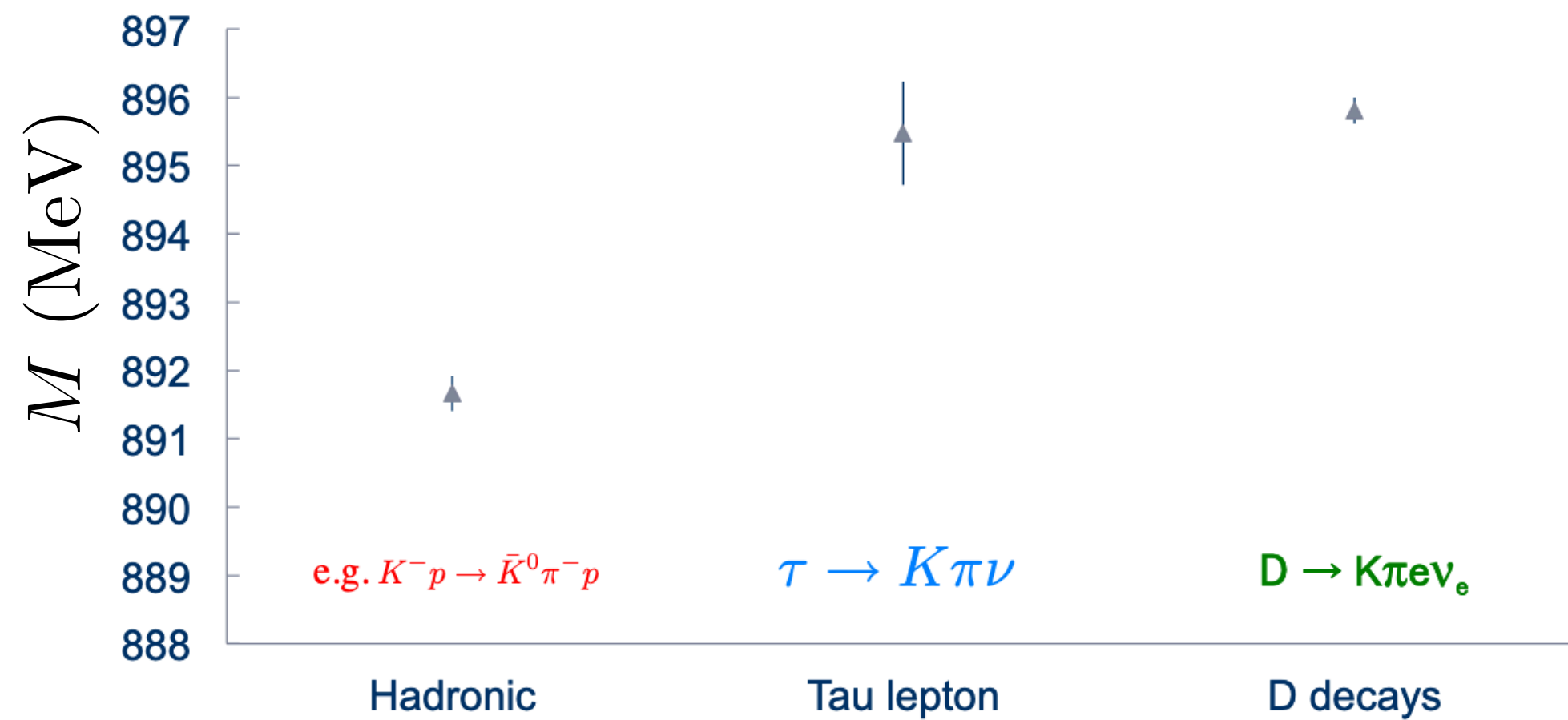

Flavor determinations and BSM searches often rely on hadronic determinations as input

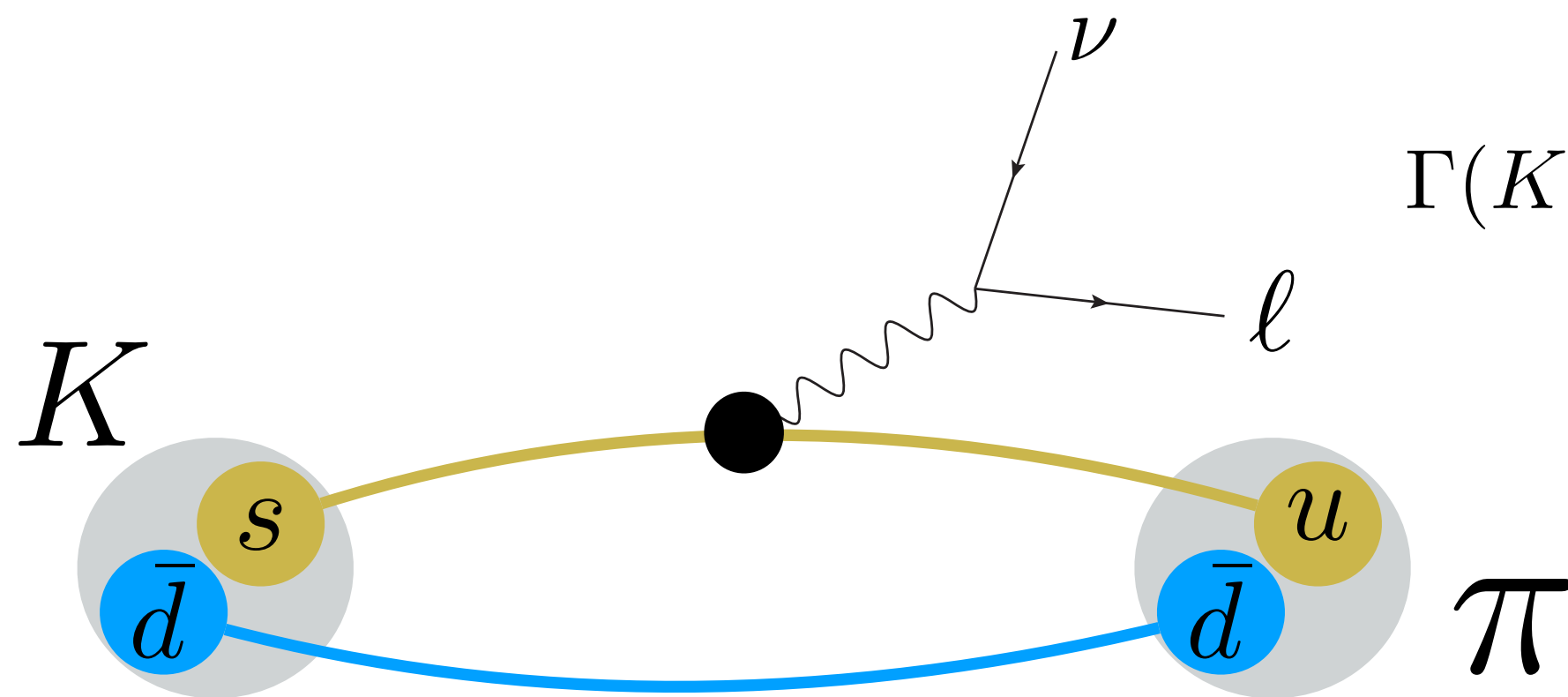

$$\Gamma(K \rightarrow \pi l \nu[\gamma]) = \frac{G_F^2 m_K^5}{192 \pi^3} C_K^2 S_E^K |V_{us}|^2 \left| f_+^{K^0 \pi^-}(0) \right|^2 I_K^l \left(1 + \delta_{\text{EM}}^{Kl} + \delta_{\text{SU}(2)}^{K\pi} \right)^2$$

Other applications?

Not even the narrow $K^*(892)$ is so well known

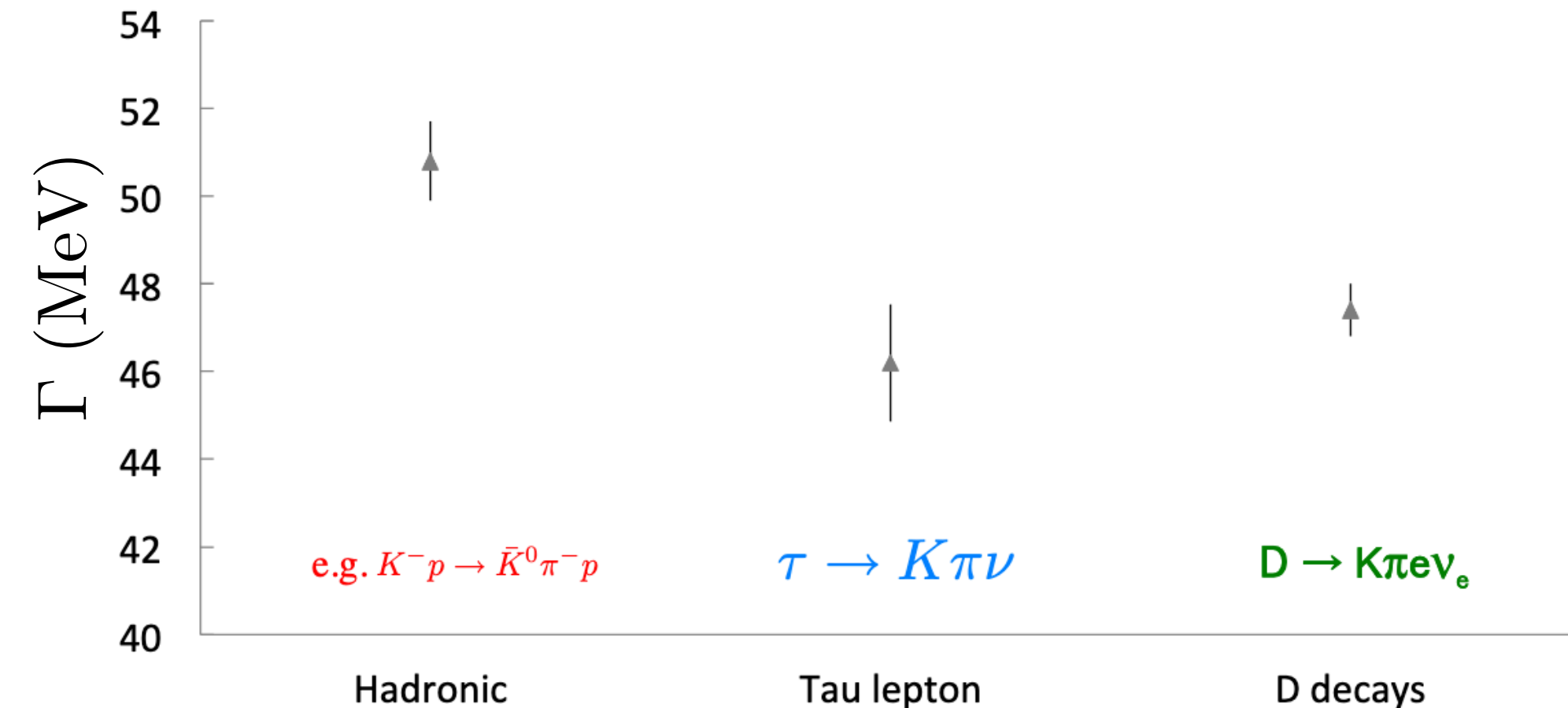
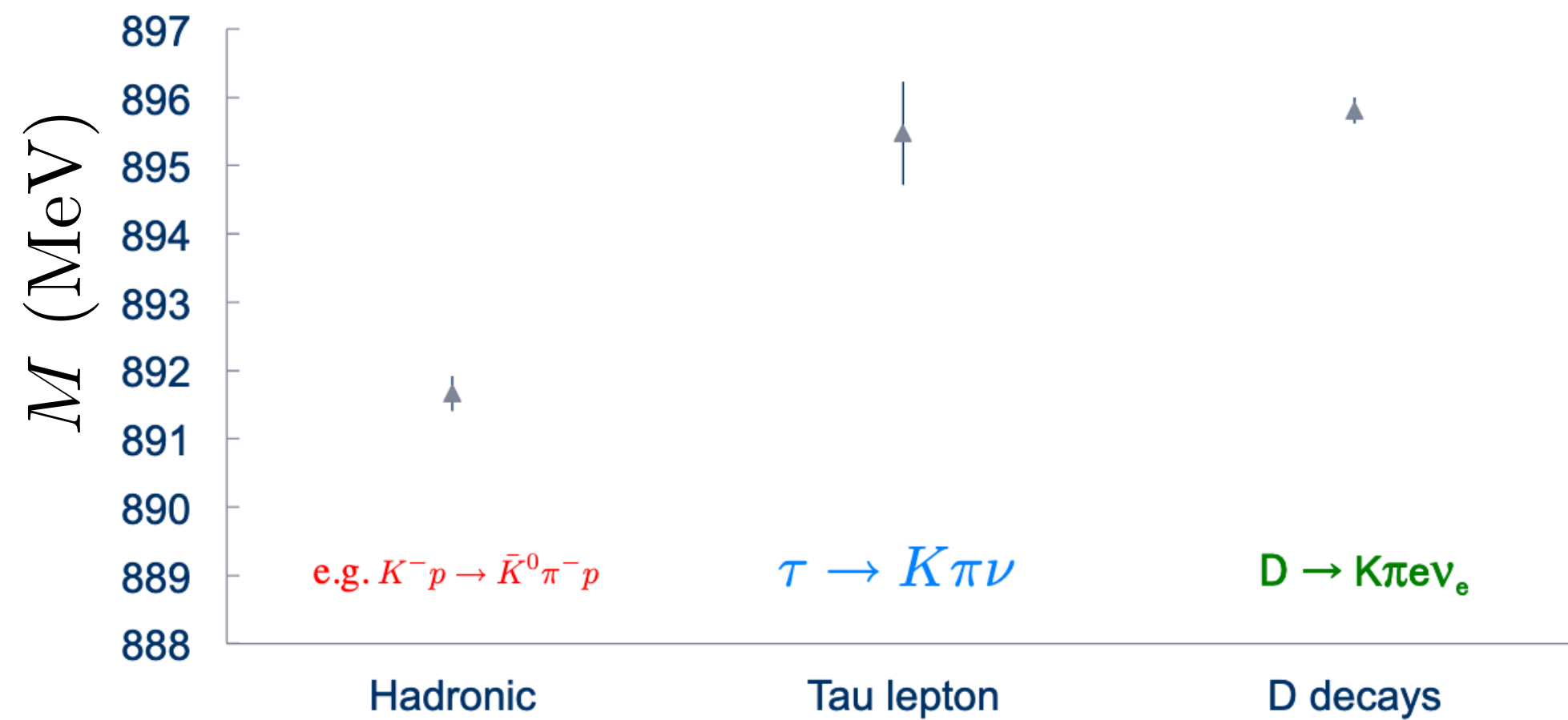

Flavor determinations and BSM searches often rely on hadronic determinations as input

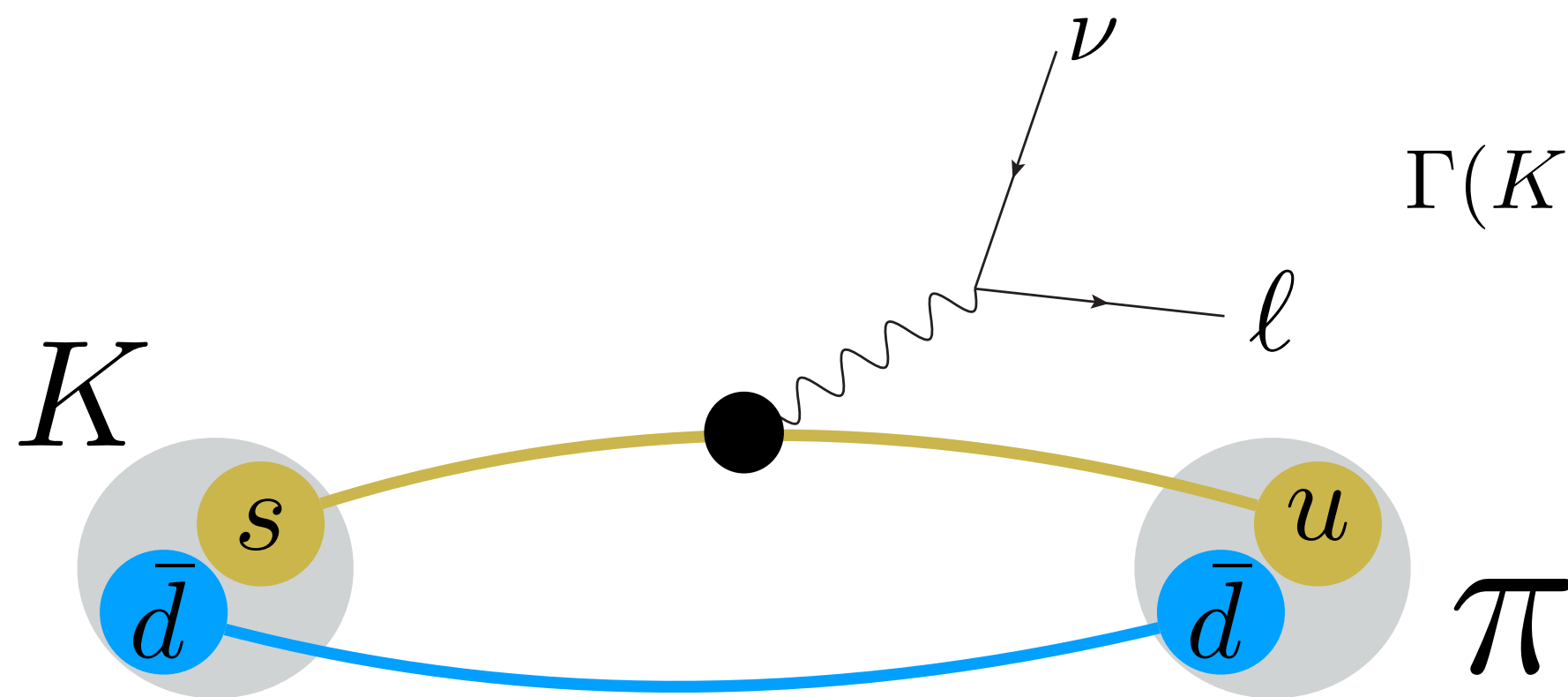

$$\Gamma(K \rightarrow \pi l \nu[\gamma]) = \frac{G_F^2 m_K^5}{192 \pi^3} C_K^2 S_E^K \underbrace{|V_{us}|^2}_{\text{CKM}} \underbrace{|f_+^{K^0 \pi^-}(0)|^2}_{\text{Vector+Scalar } \pi K \text{ form factors}} \underbrace{I_K^l}_{\text{CKM}} \left(1 + \delta_{\text{EM}}^{Kl} + \delta_{\text{SU}(2)}^{K\pi}\right)^2$$

CKM

Vector+Scalar πK form factors

Challenge I

The BW has worked wonders in many cases

$$t_\ell(s) \sim \frac{\sqrt{s}\Gamma(s)}{m^2 - s - i\sqrt{s}\Gamma(s)}$$

$$\sqrt{s_p} = m + i\Gamma/2$$

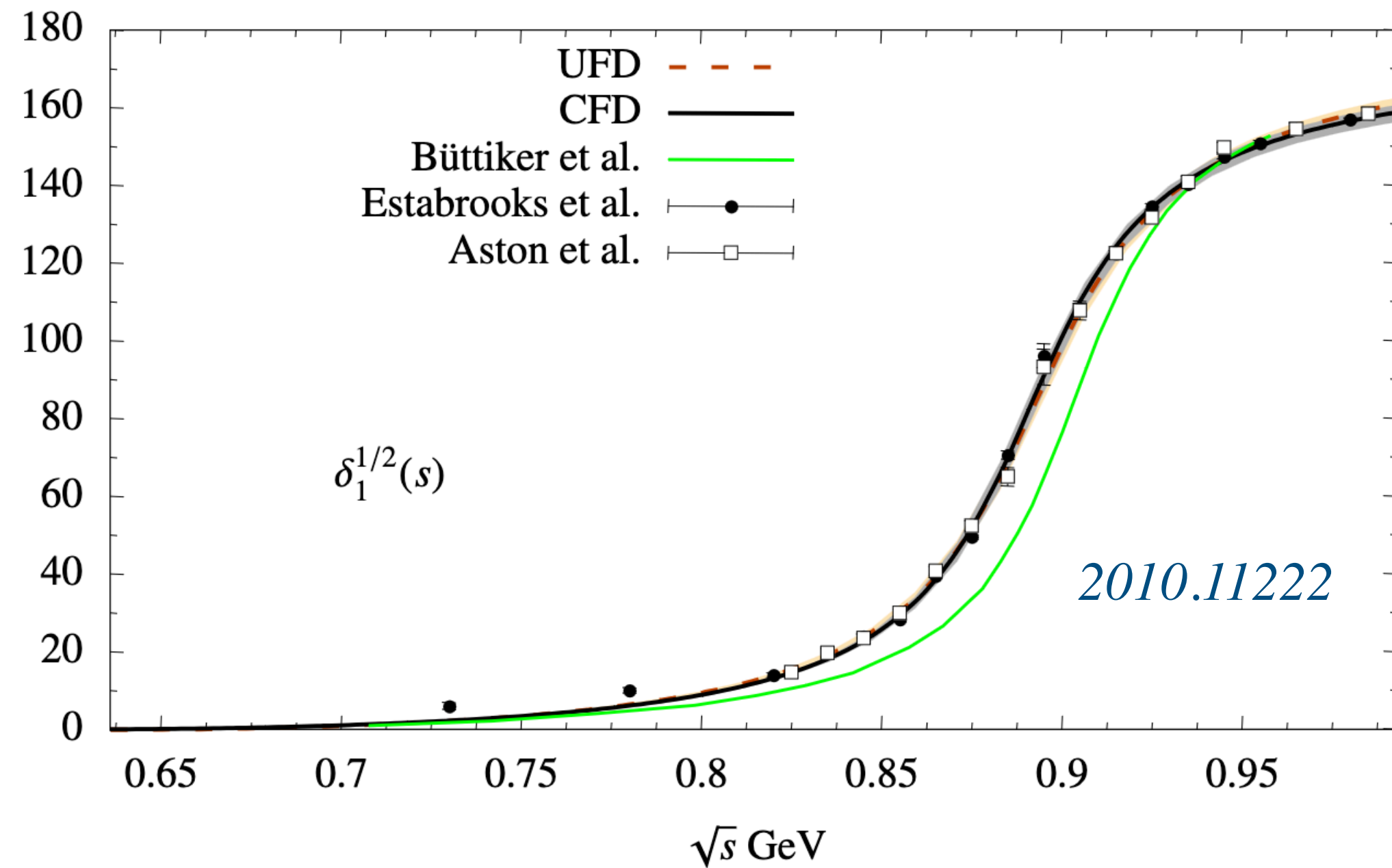

Life is easy...
sometimes

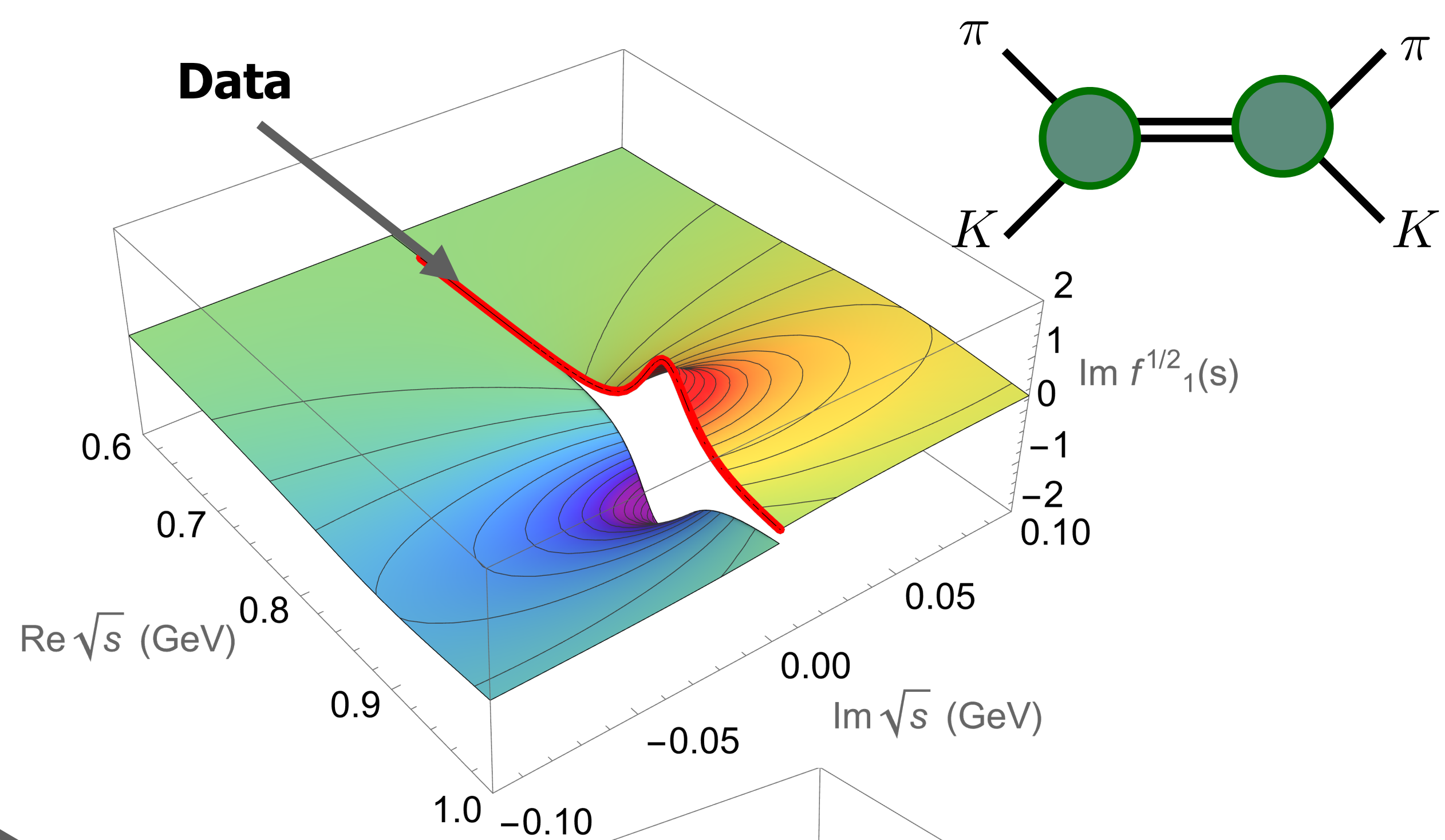

K^*

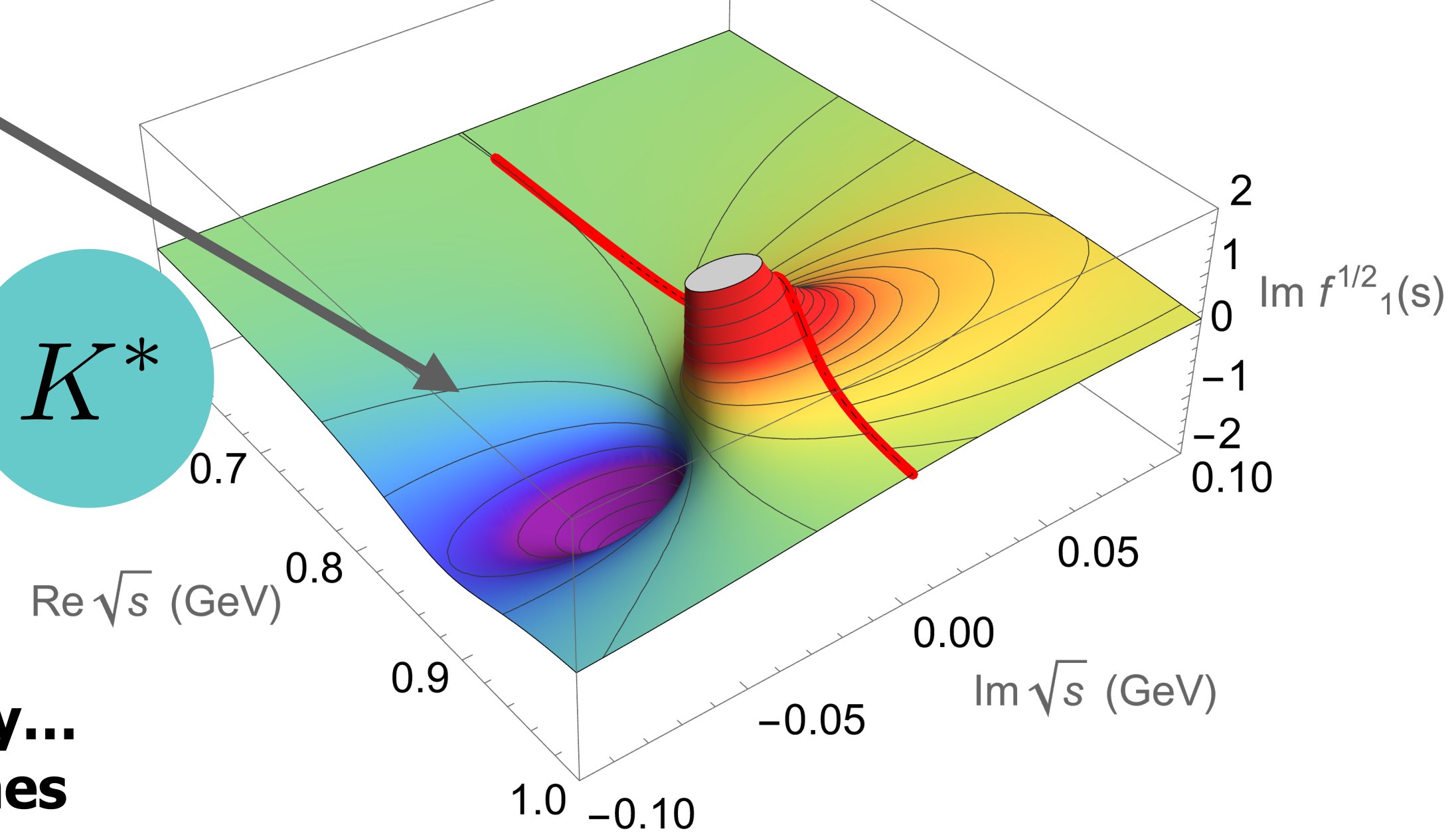

Scattering

Definitely not a BW

$$t_\ell(s) \sim ??$$

JRP talk

What's this??

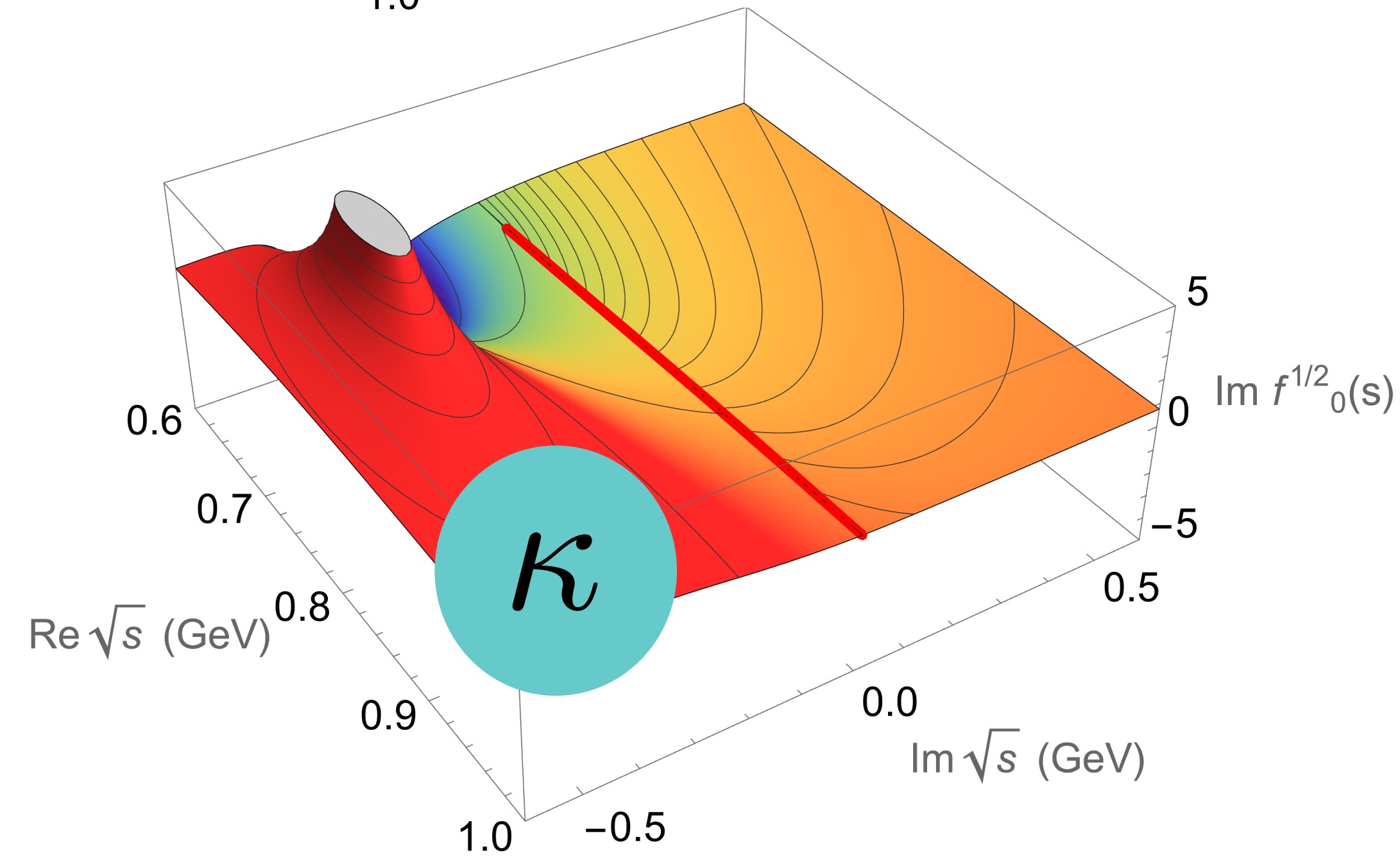
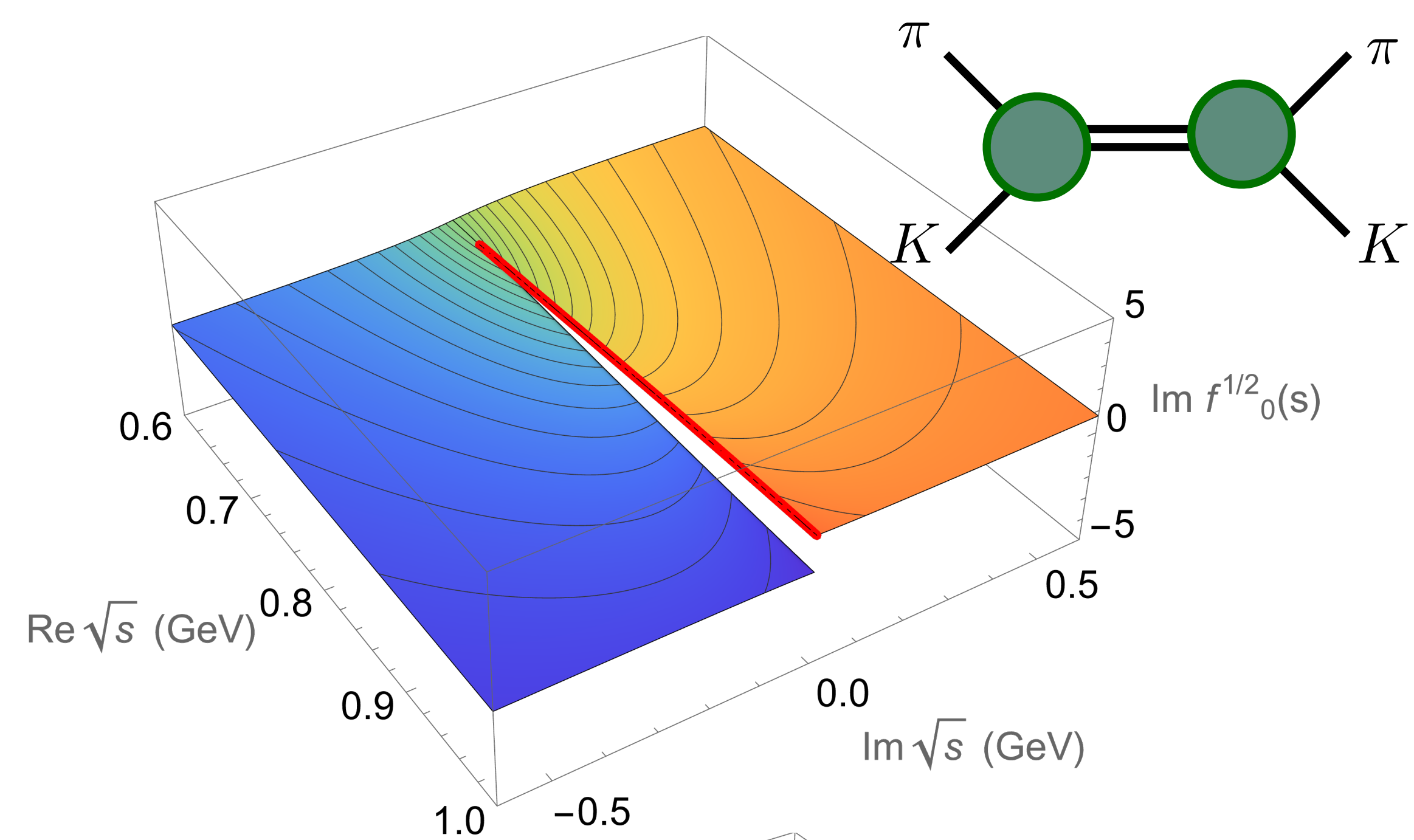
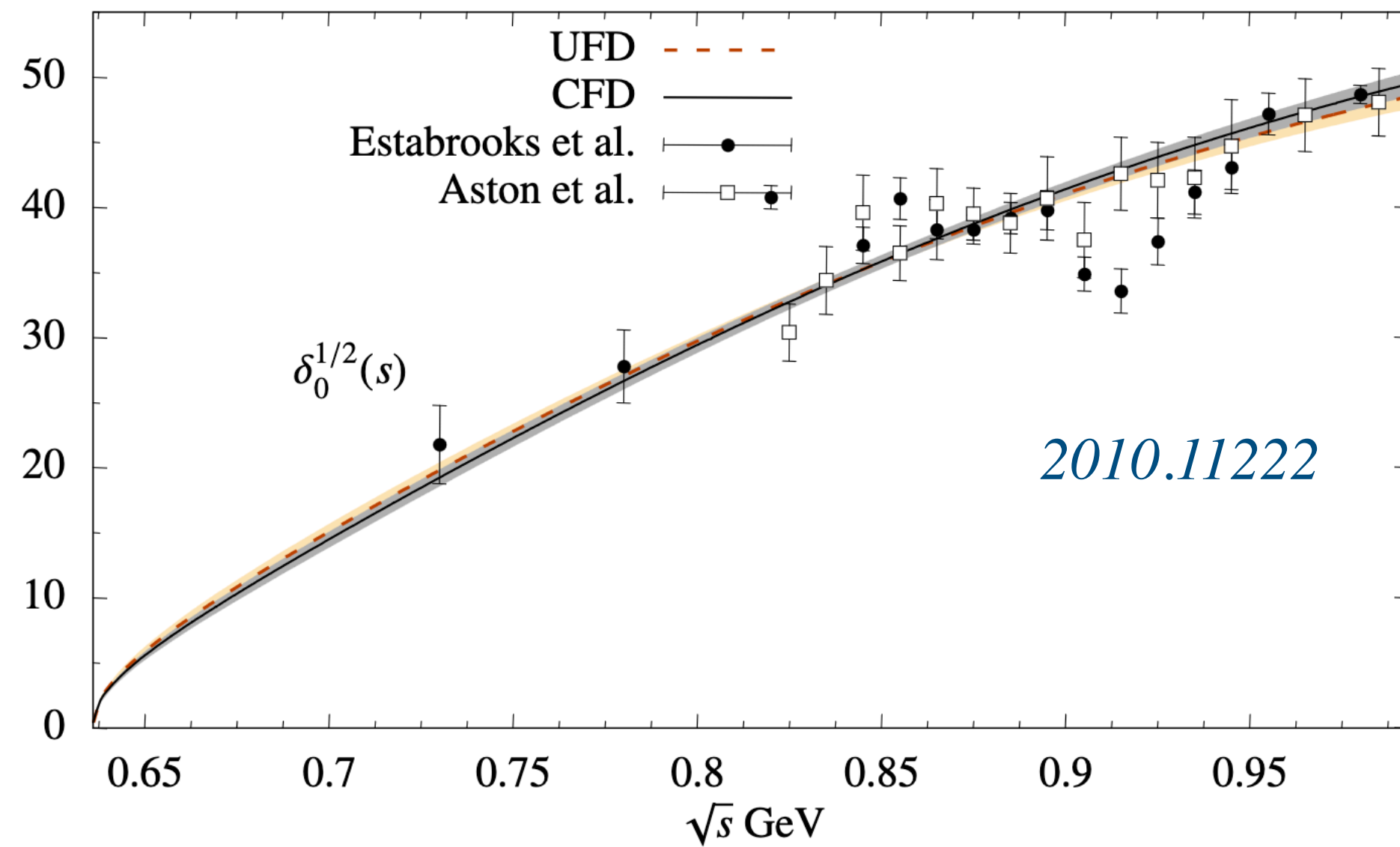

Challenge II

$$c\tau_{\pi^+} = 7.8 \text{ m}$$

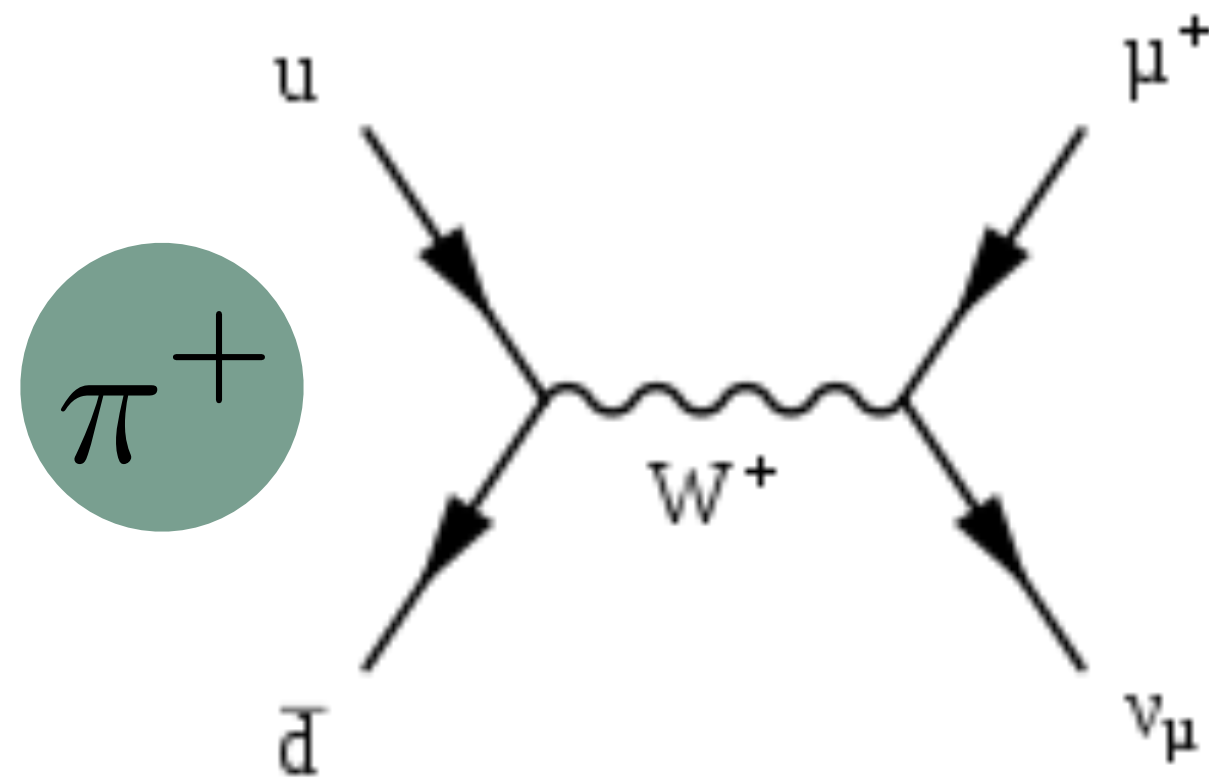

$$c\tau_K = 3.7 \text{ m}$$

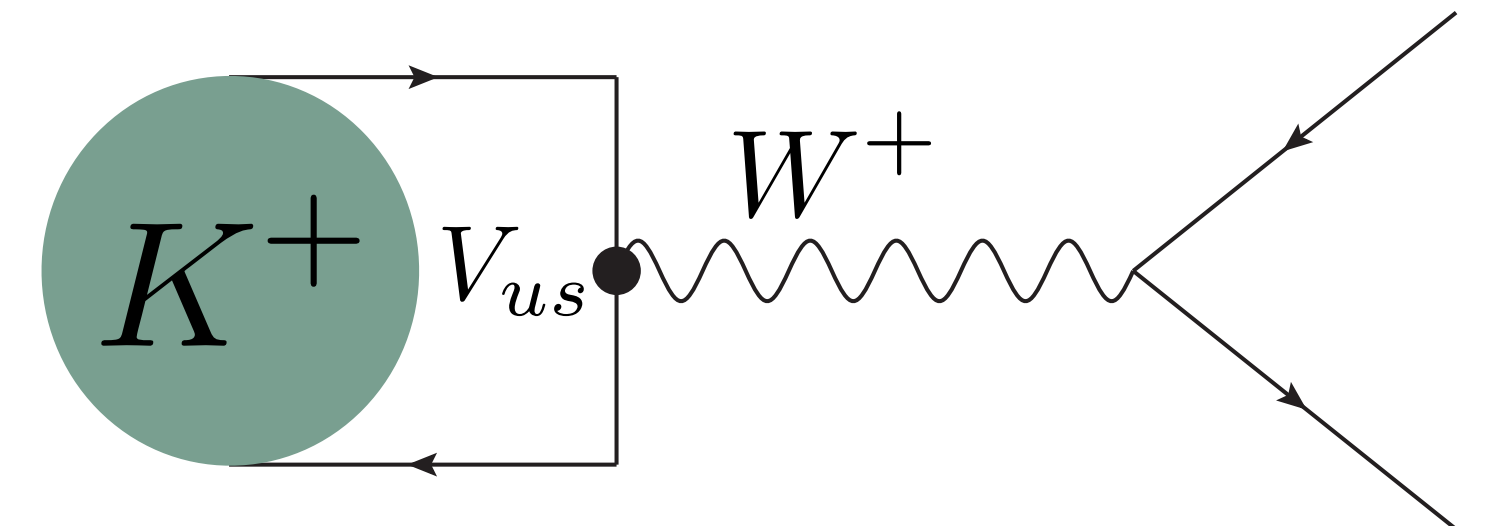

Mesons decay

One beam?? (maybe)

Not two beams

“Data” is not data

For meson-meson data must be always modeled

Some systematic uncertainties unknown

Challenge II

$$c\tau_{\pi^+} = 7.8 \text{ m}$$

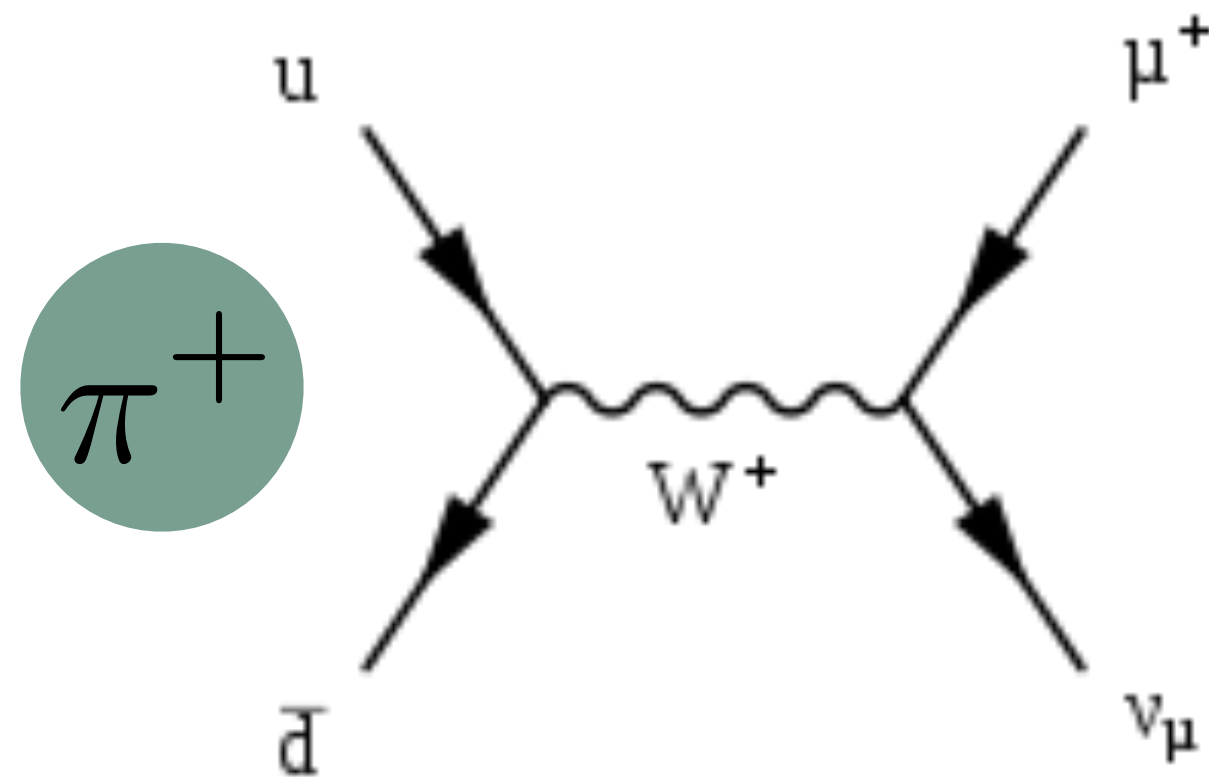

$$c\tau_K = 3.7 \text{ m}$$

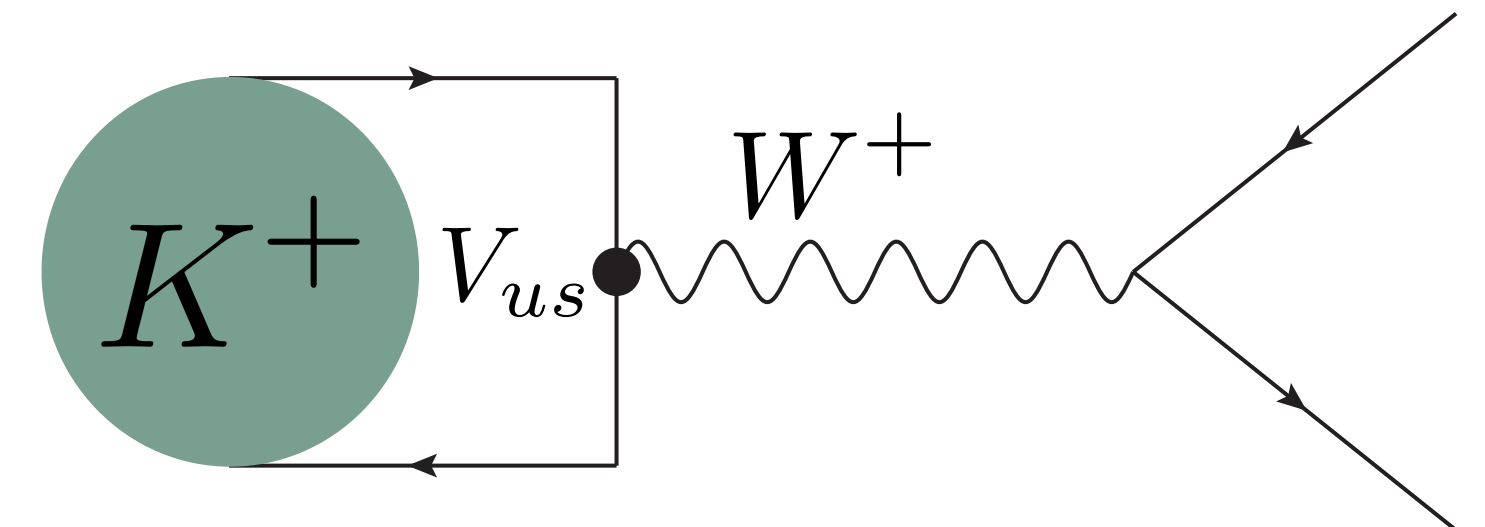

“Data” is not data

For meson-meson data must be always modeled

Some systematic uncertainties unknown

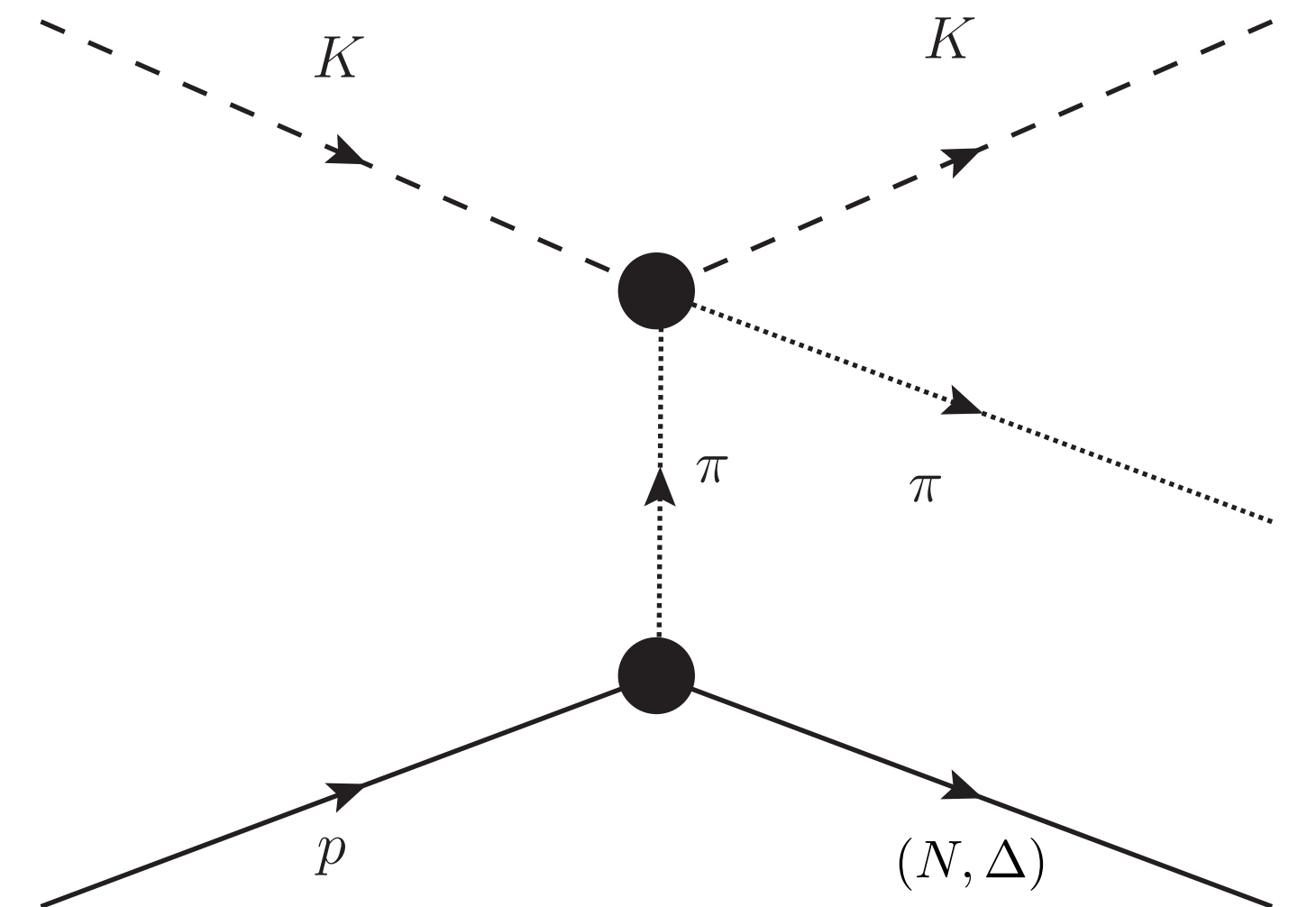

Mesons decay

One beam?? (maybe)

Not two beams

πK scattering

Heavier modeling

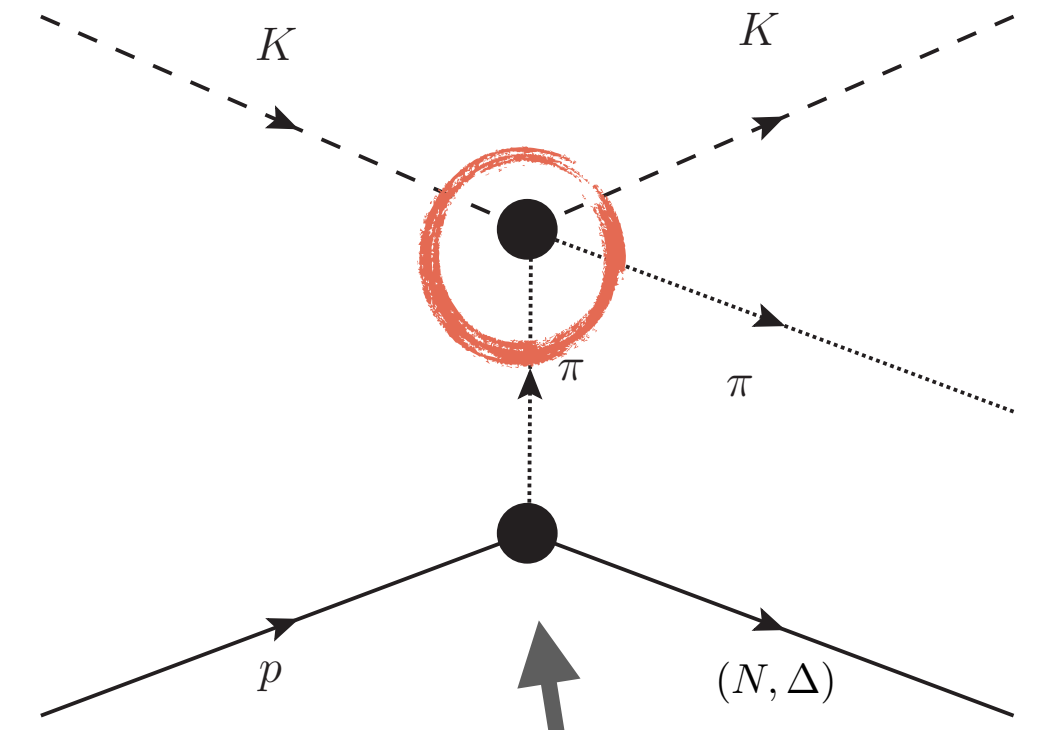
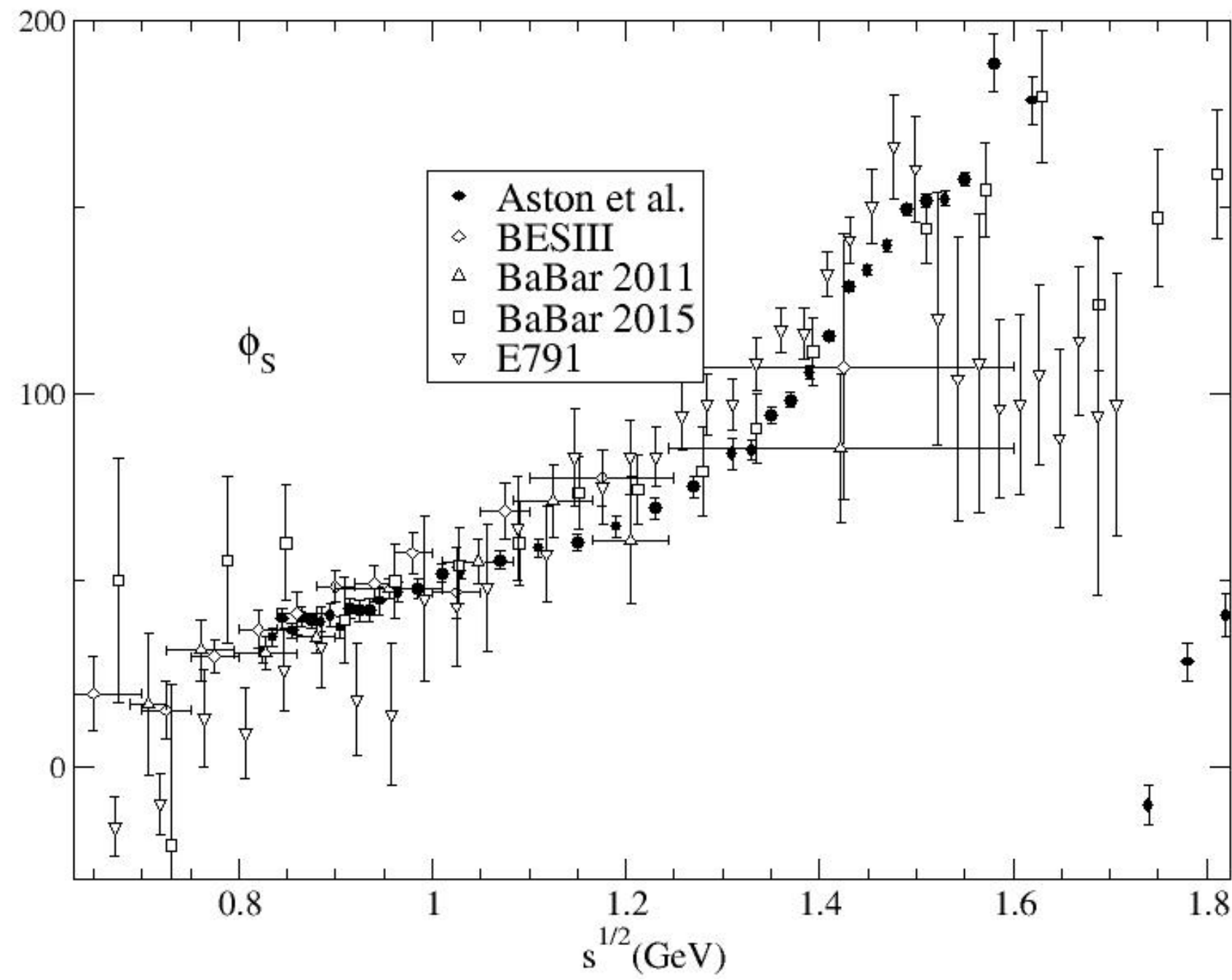
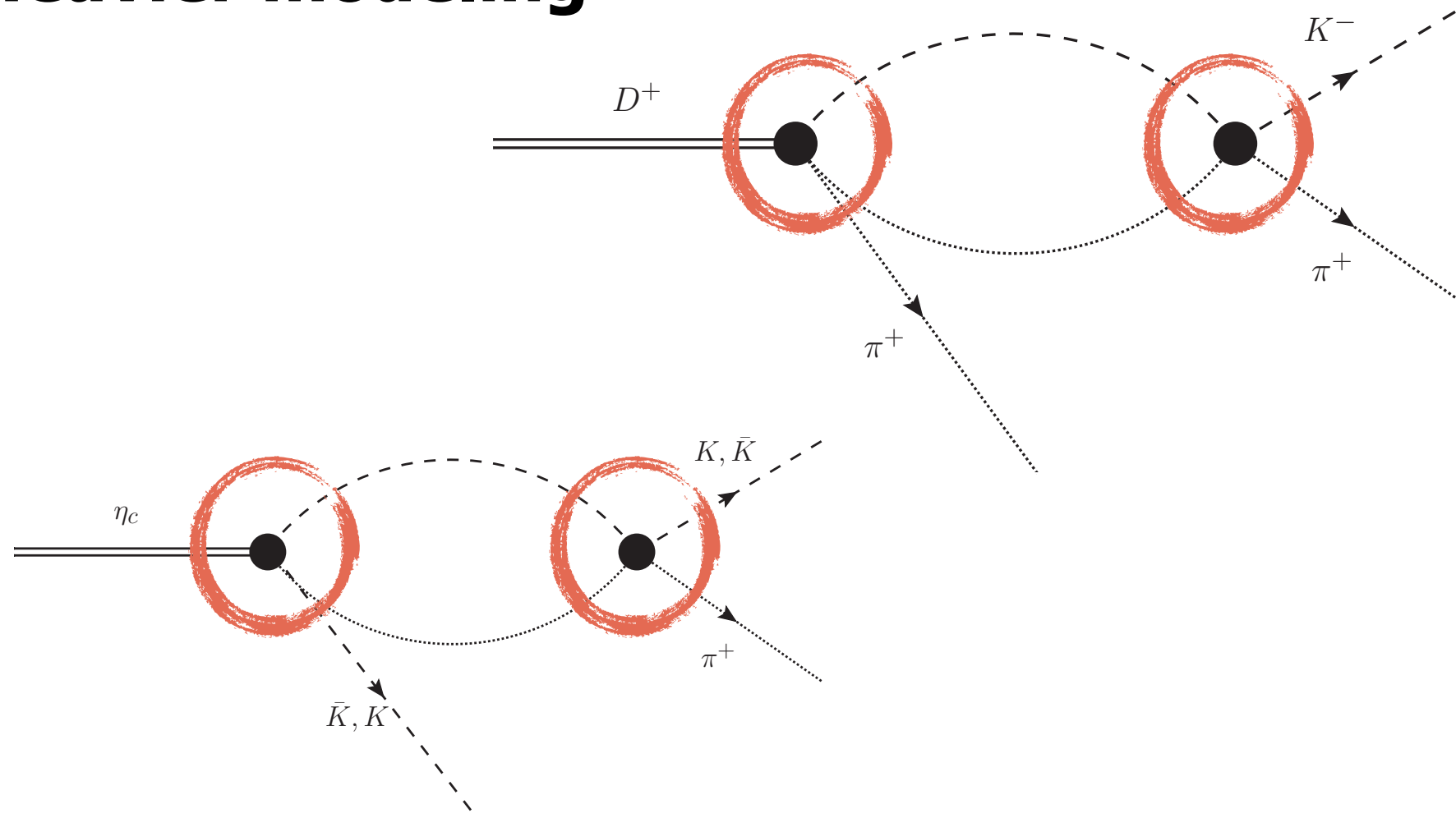

Not great statistics

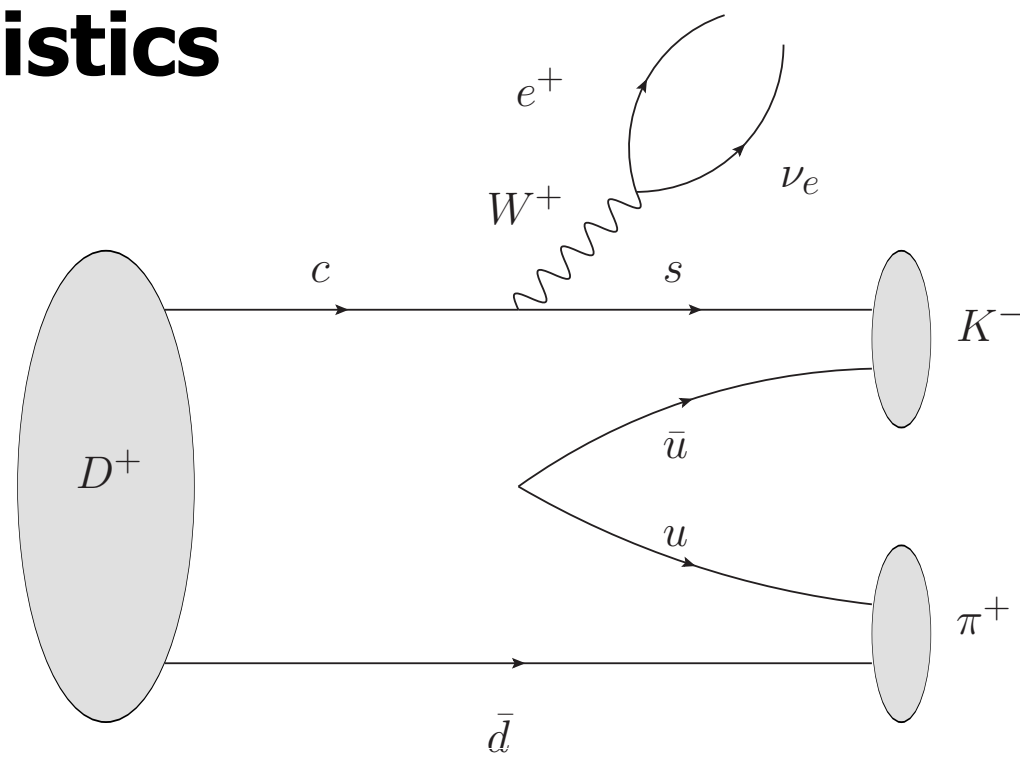

Production offers most precise results, by far

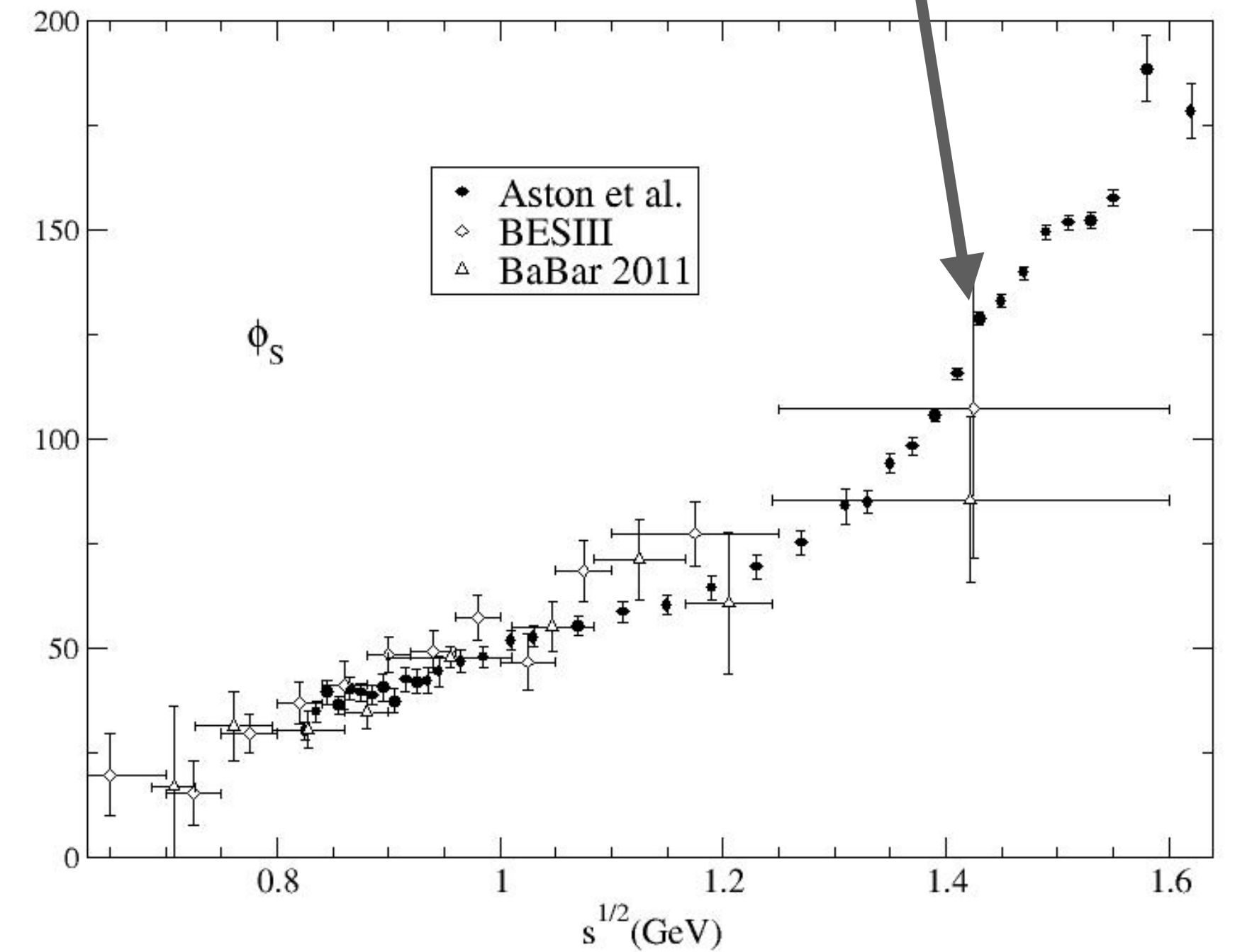

πK scattering

Heavier modeling

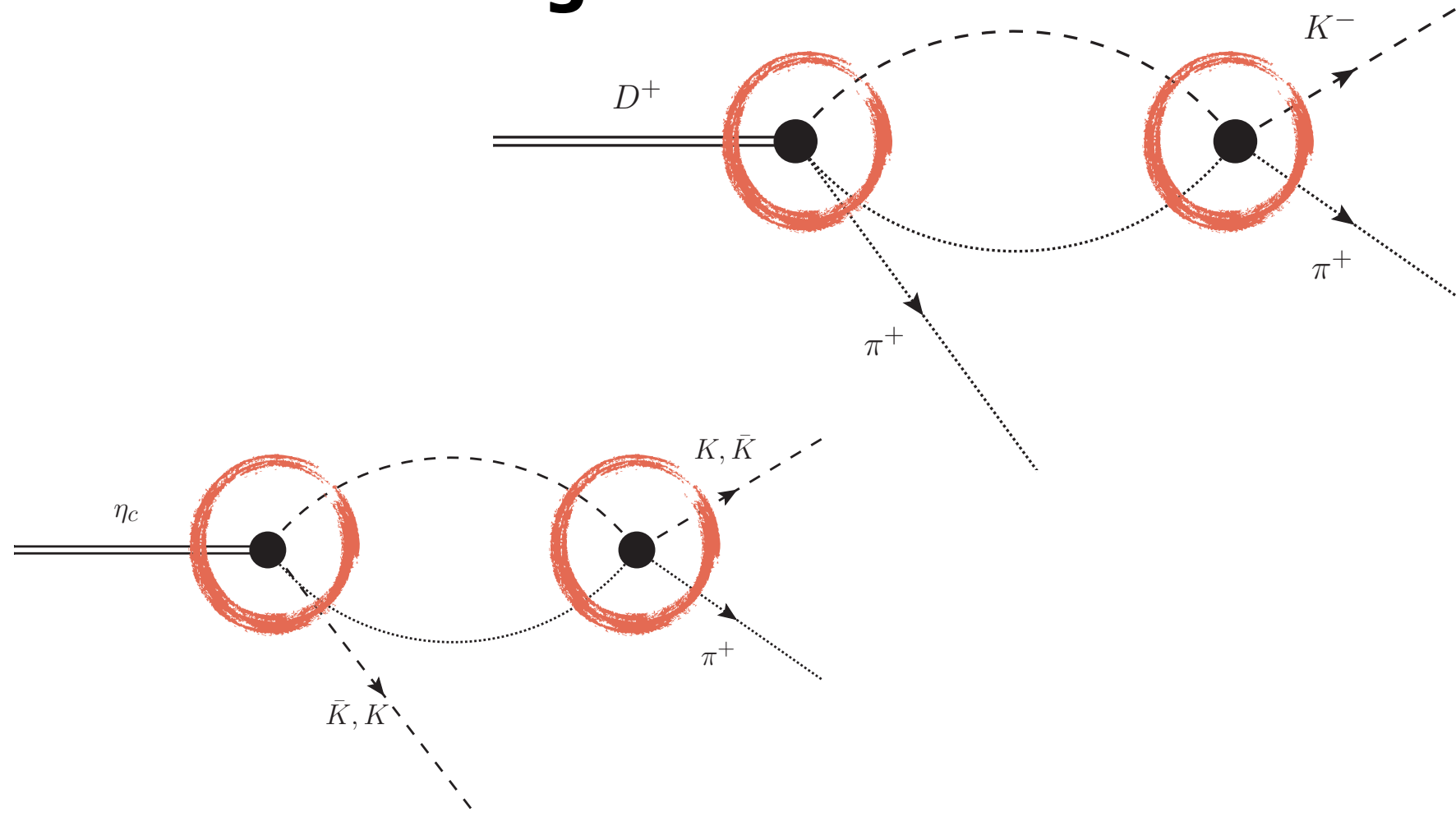

Not great statistics

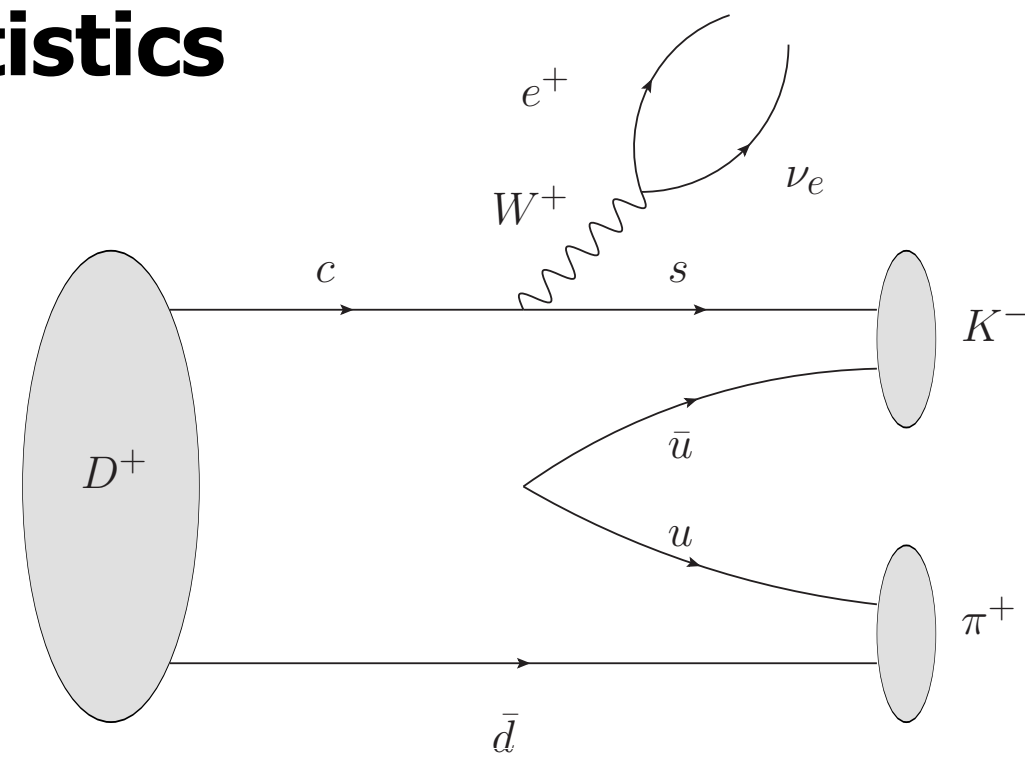

Production offers most precise results, by far

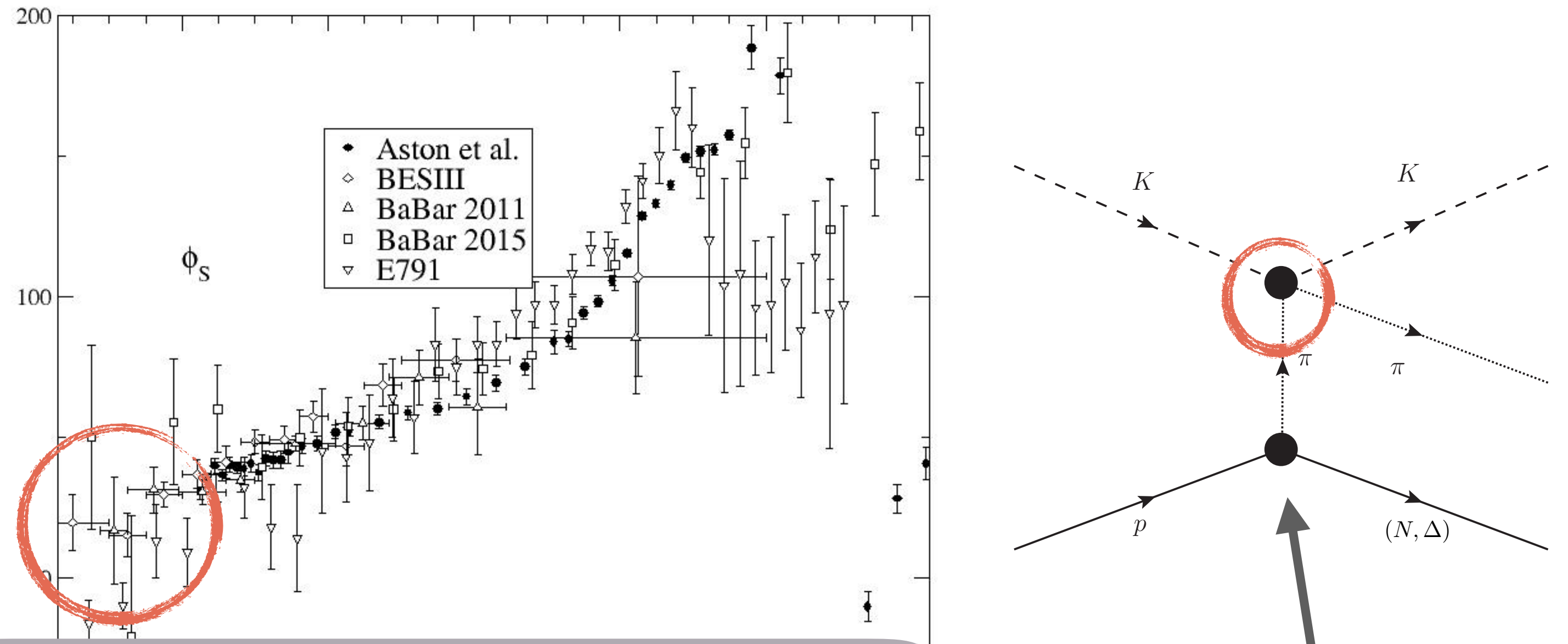

No data at low $m_{\pi K}$

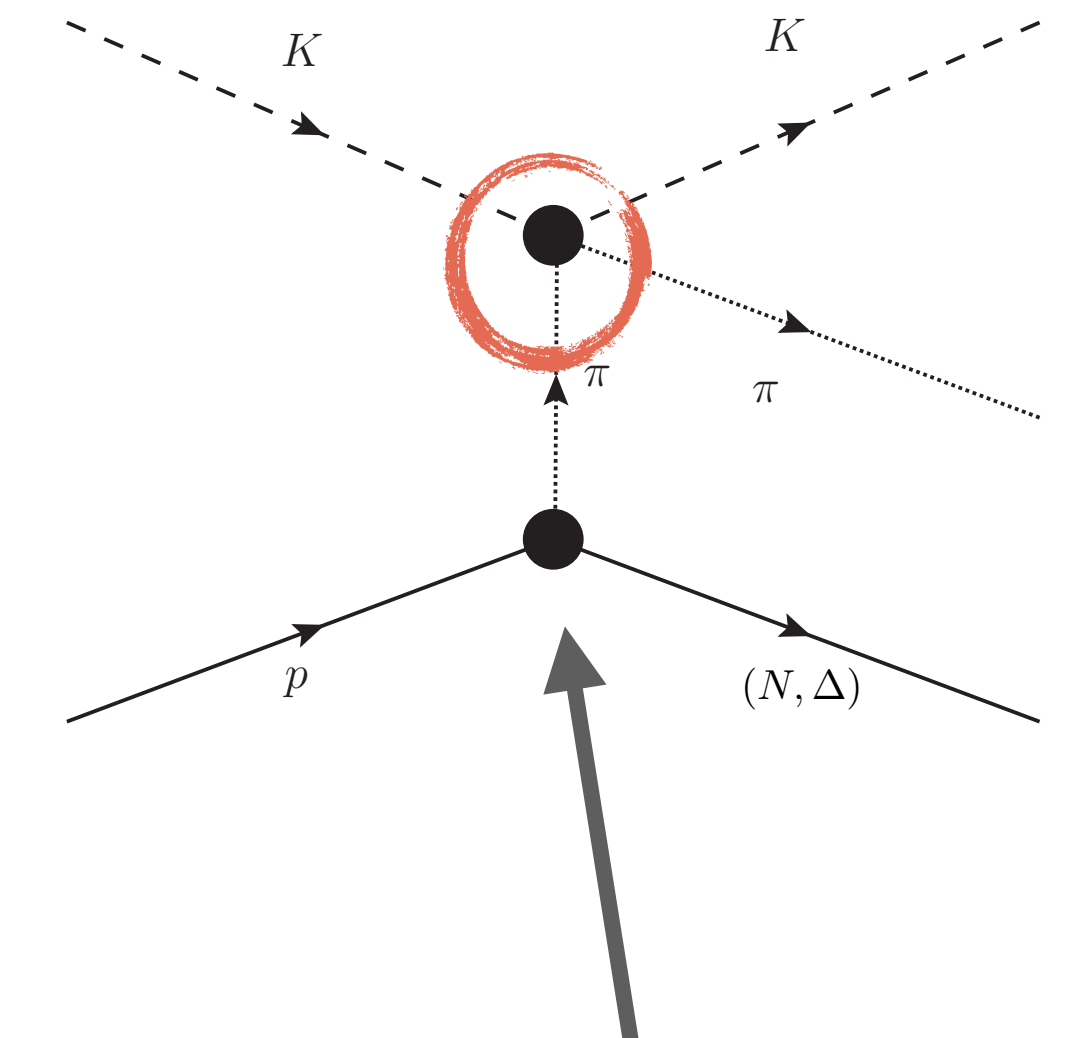
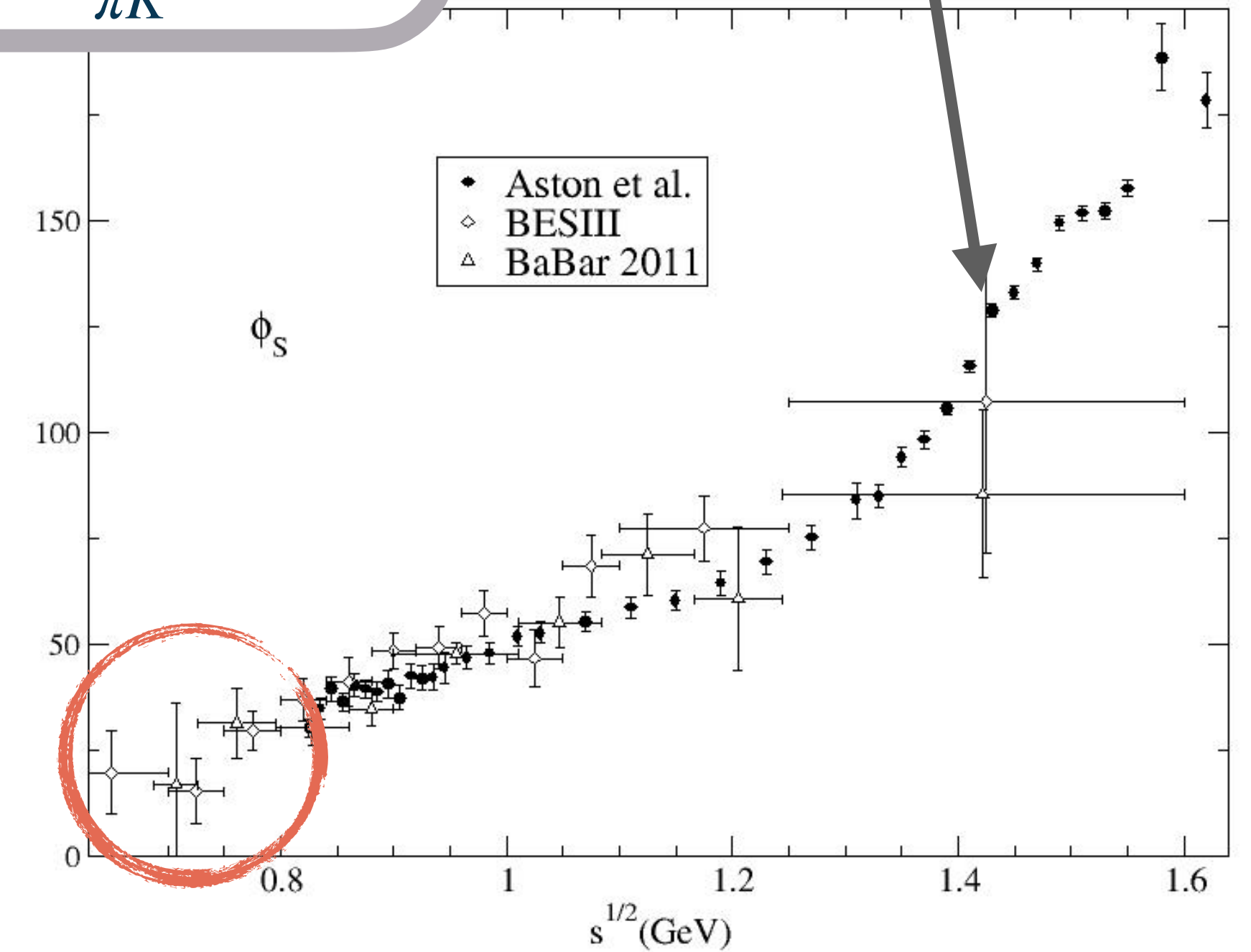

Challenge II

We can have a single meson beam

We want real pions, not virtual

What if we model the virtual pion?

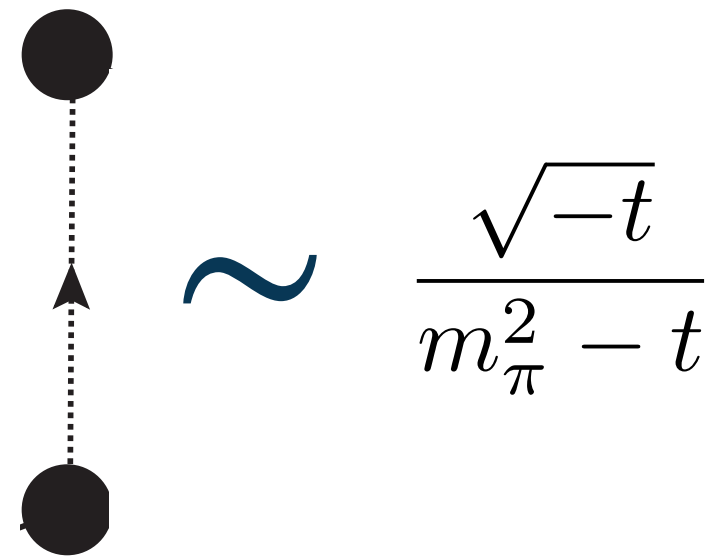

$$\sim \frac{\sqrt{-t}}{m_\pi^2 - t}$$

$$L_0(s, t) \sim f_L(s) \frac{\sqrt{-t}}{m_\pi^2 - t}$$

$$\frac{d\sigma}{dt}(s, t) \sim \sum |L_\lambda^{(\pm)}(s, t)|^2$$

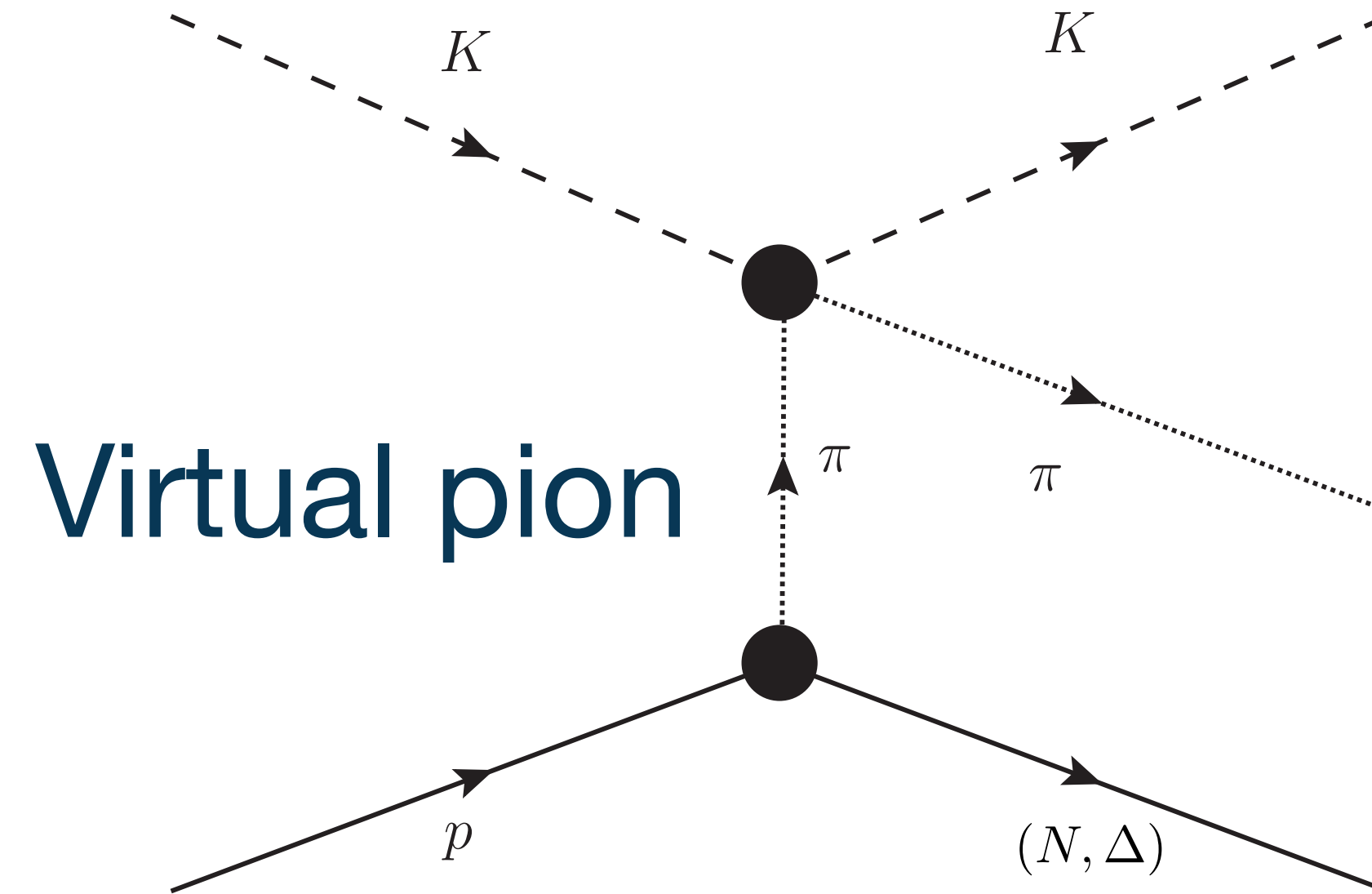

Virtual pion

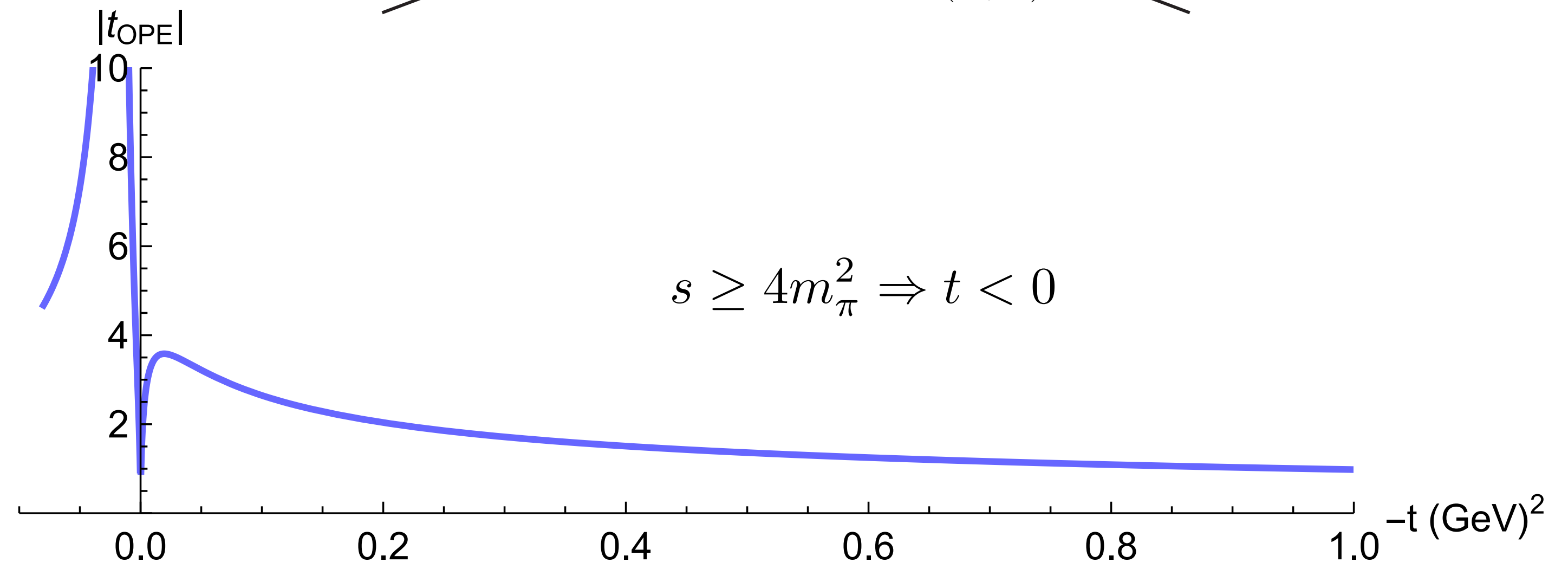

Challenge II

Not all t values are reachable

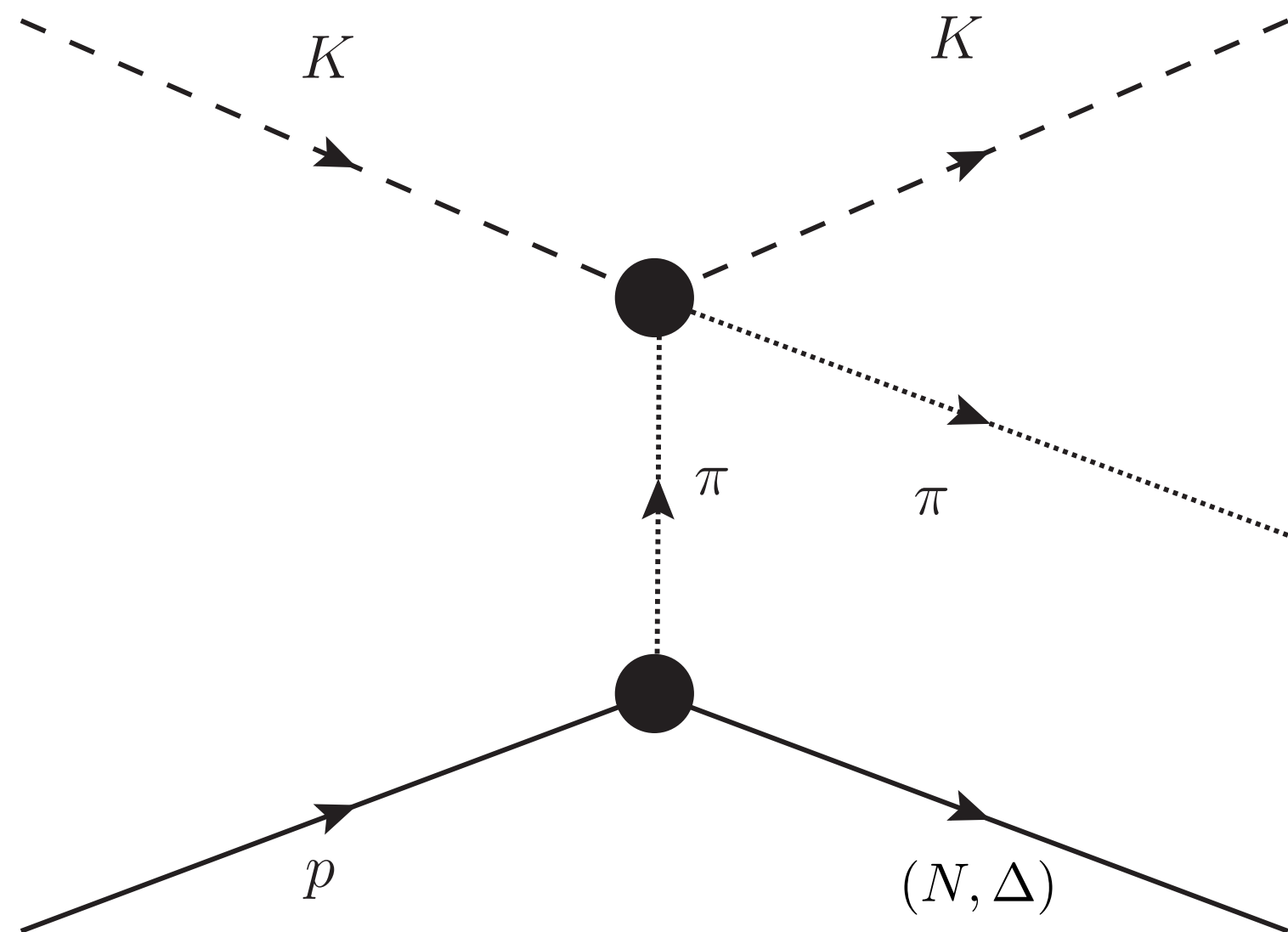

Not all theoretically reachable t values are measurable in practice

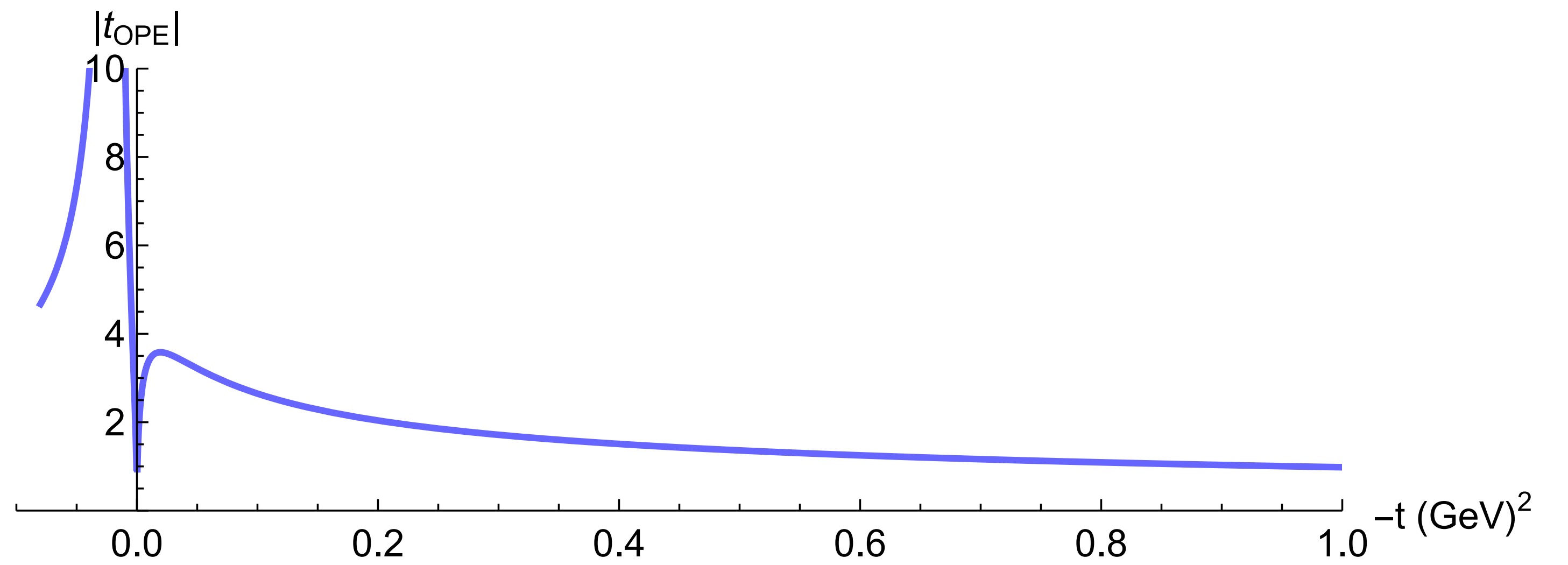

$$t_{\min}(s') = \left[\frac{m_K^2 - m_{\pi K}^2 - m_N^2 + m_{(N,\Delta)}^2}{2\sqrt{s'}} \right]^2 - (p_{1 \text{ cm}}(s') - p_{3 \text{ cm}}(s'))^2$$

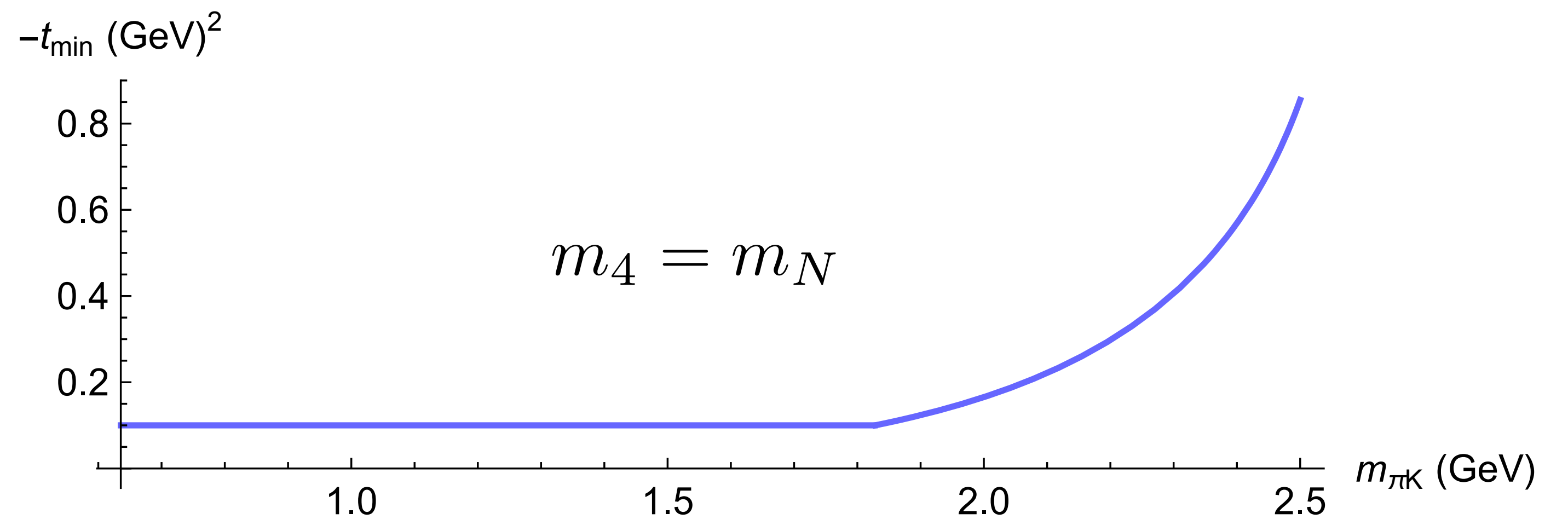

Challenge II

Not all t values are reachable

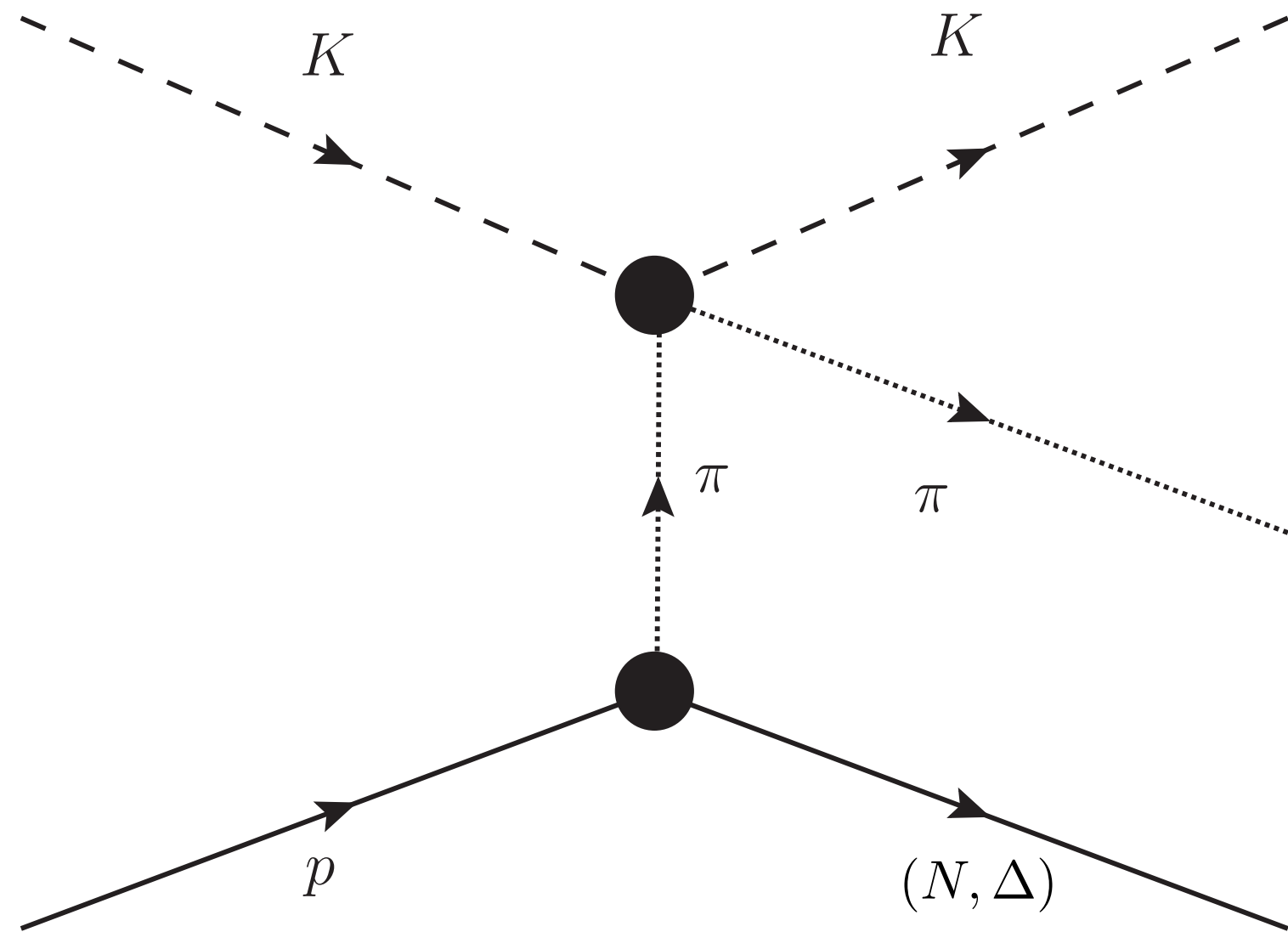

Not all theoretically reachable t values are measurable in practice

Largest resonance mass

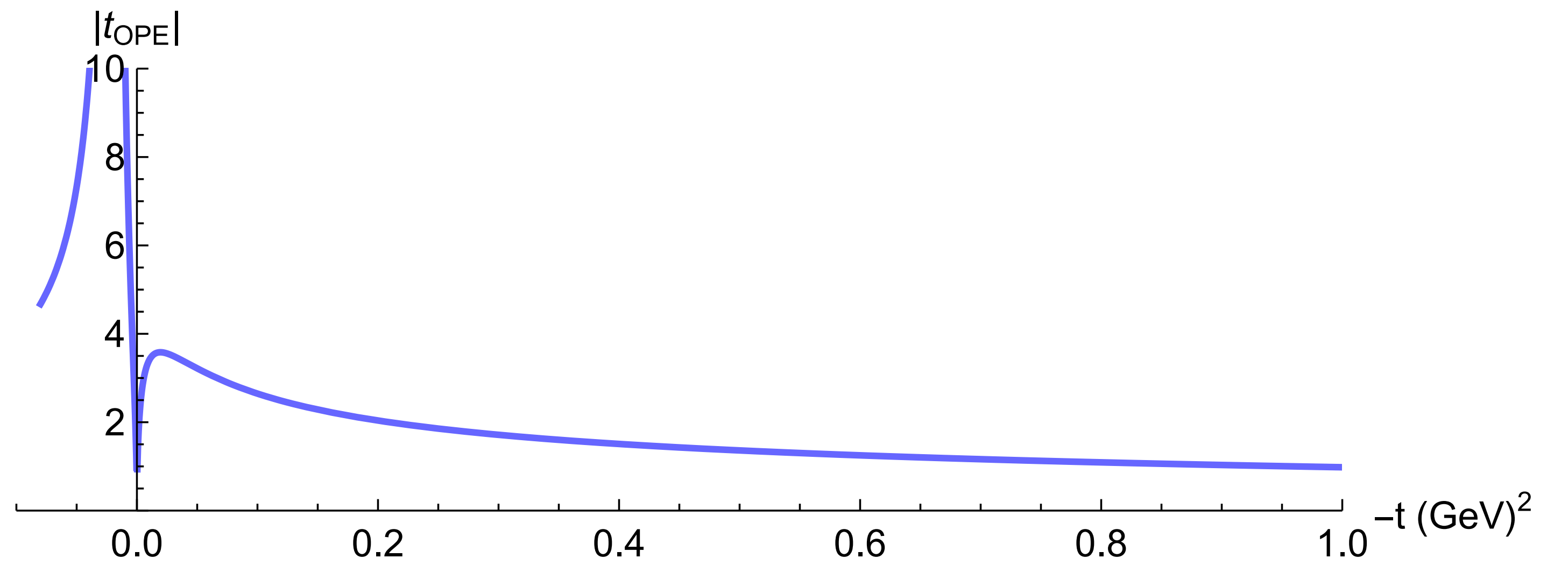

$$t_{\min}(s') = \left[\frac{m_K^2 - m_{\pi K}^2 - m_N^2 + m_{(N,\Delta)}^2}{2\sqrt{s'}} \right]^2 - (p_{1 \text{ cm}}(s') - p_{3 \text{ cm}}(s'))^2$$

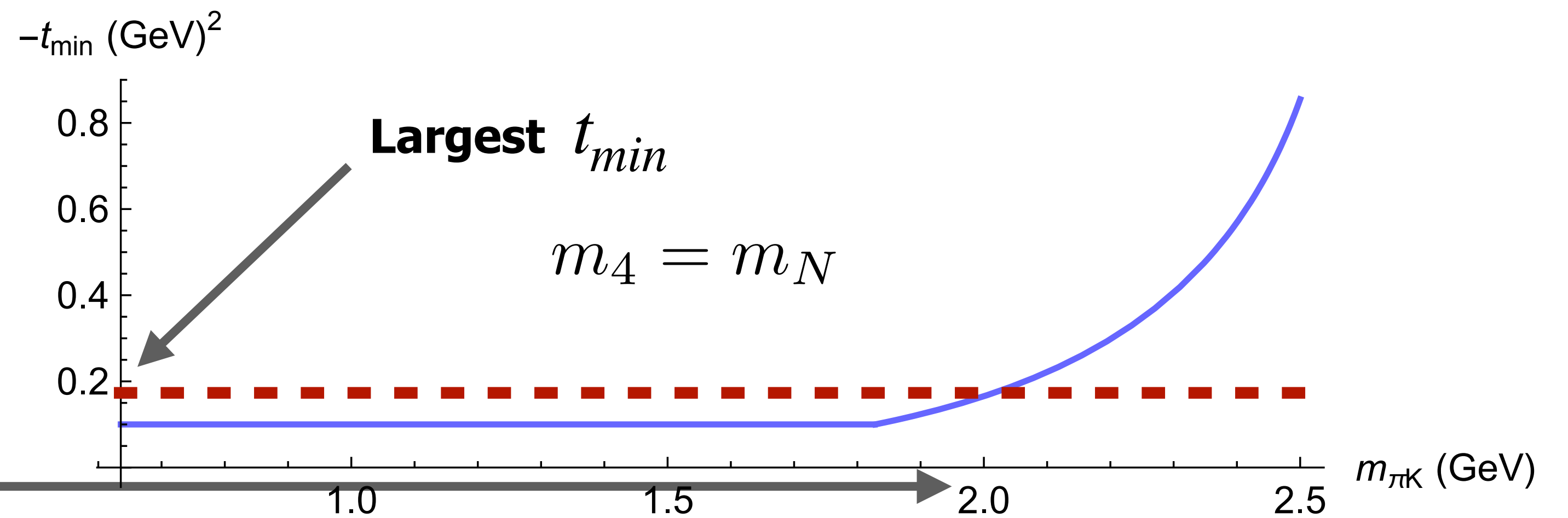

Challenge II

We exchange more than pions

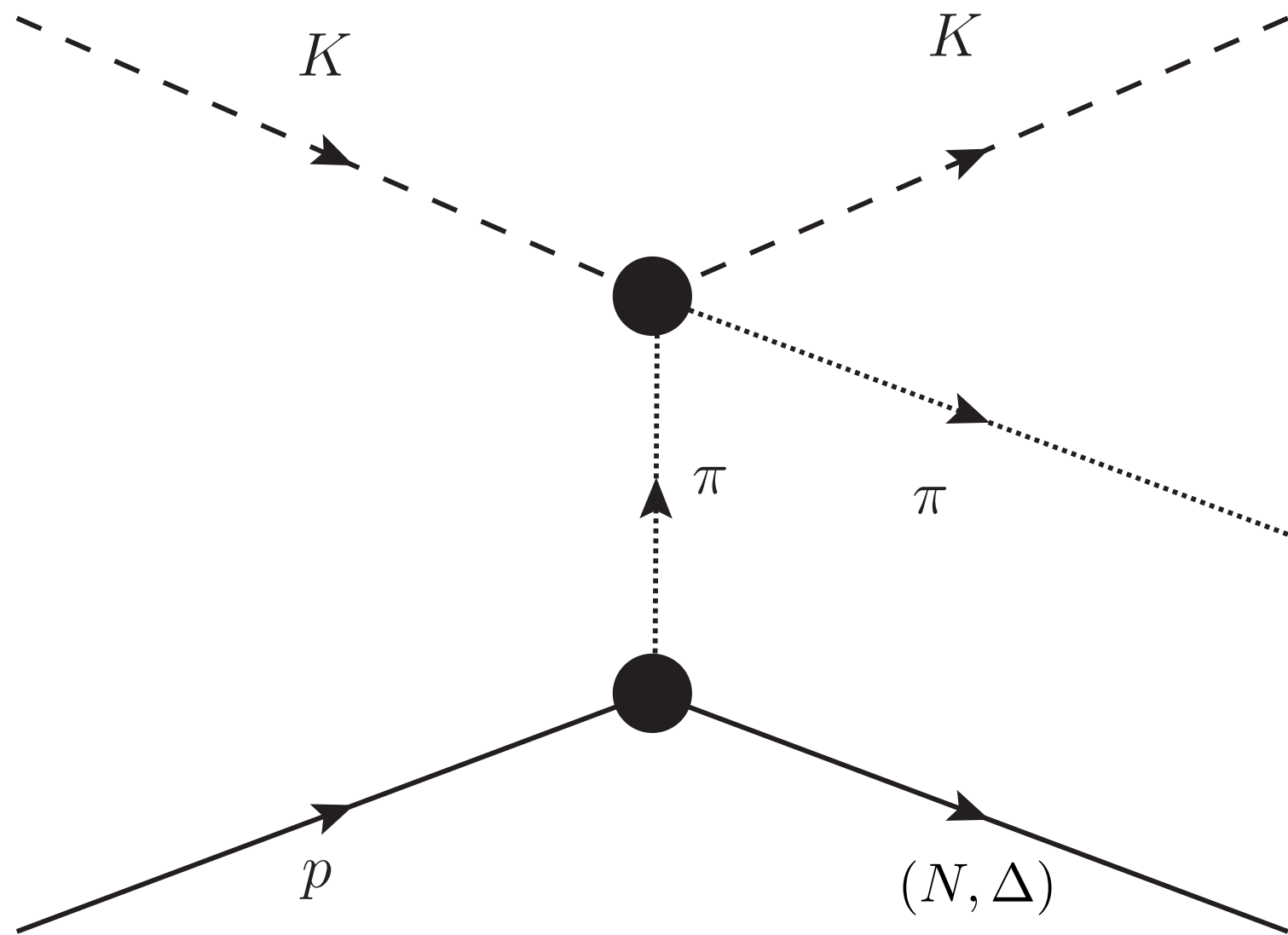

Challenge II

We exchange more than pions

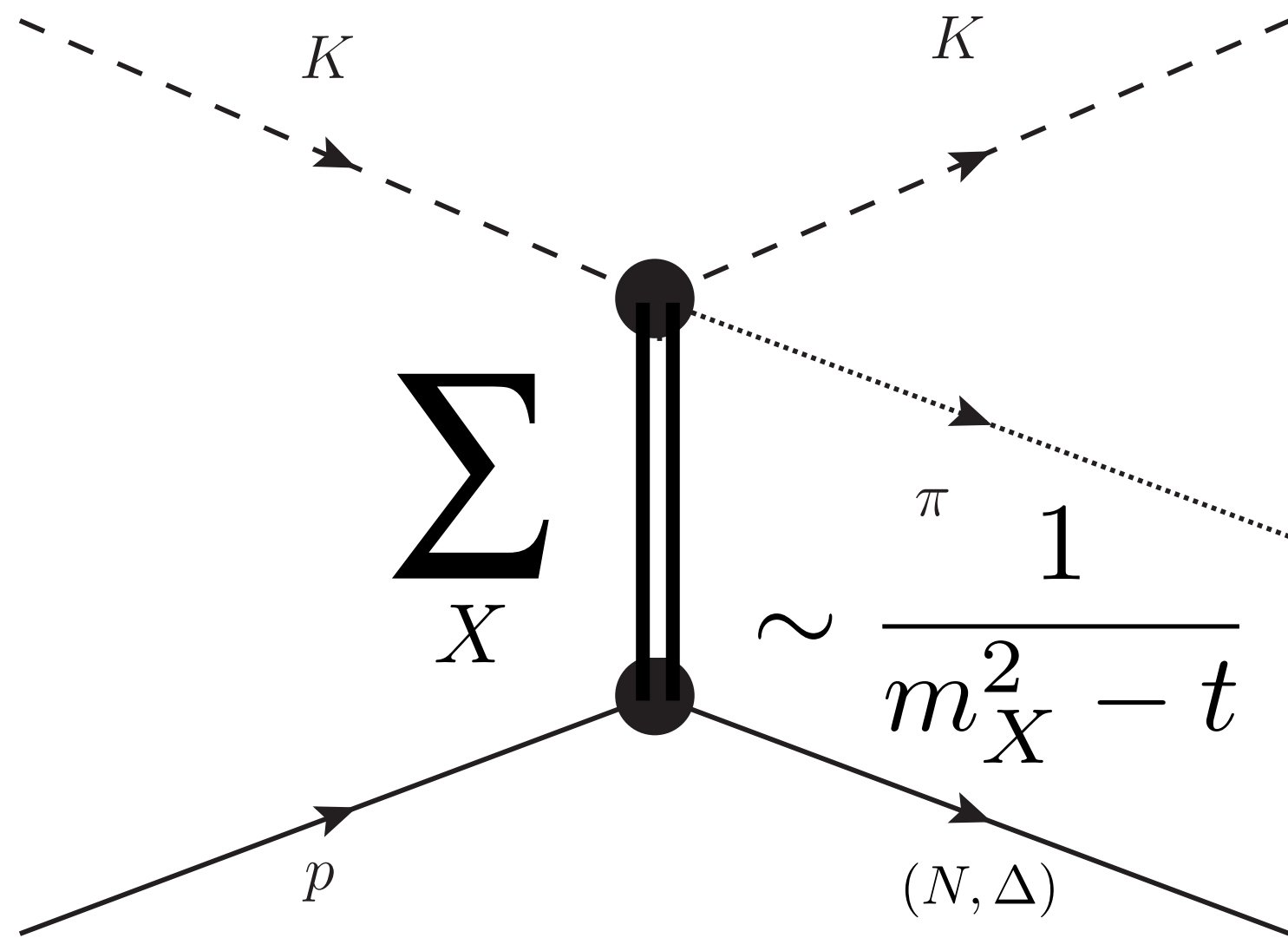

Challenge II

We exchange more than pions

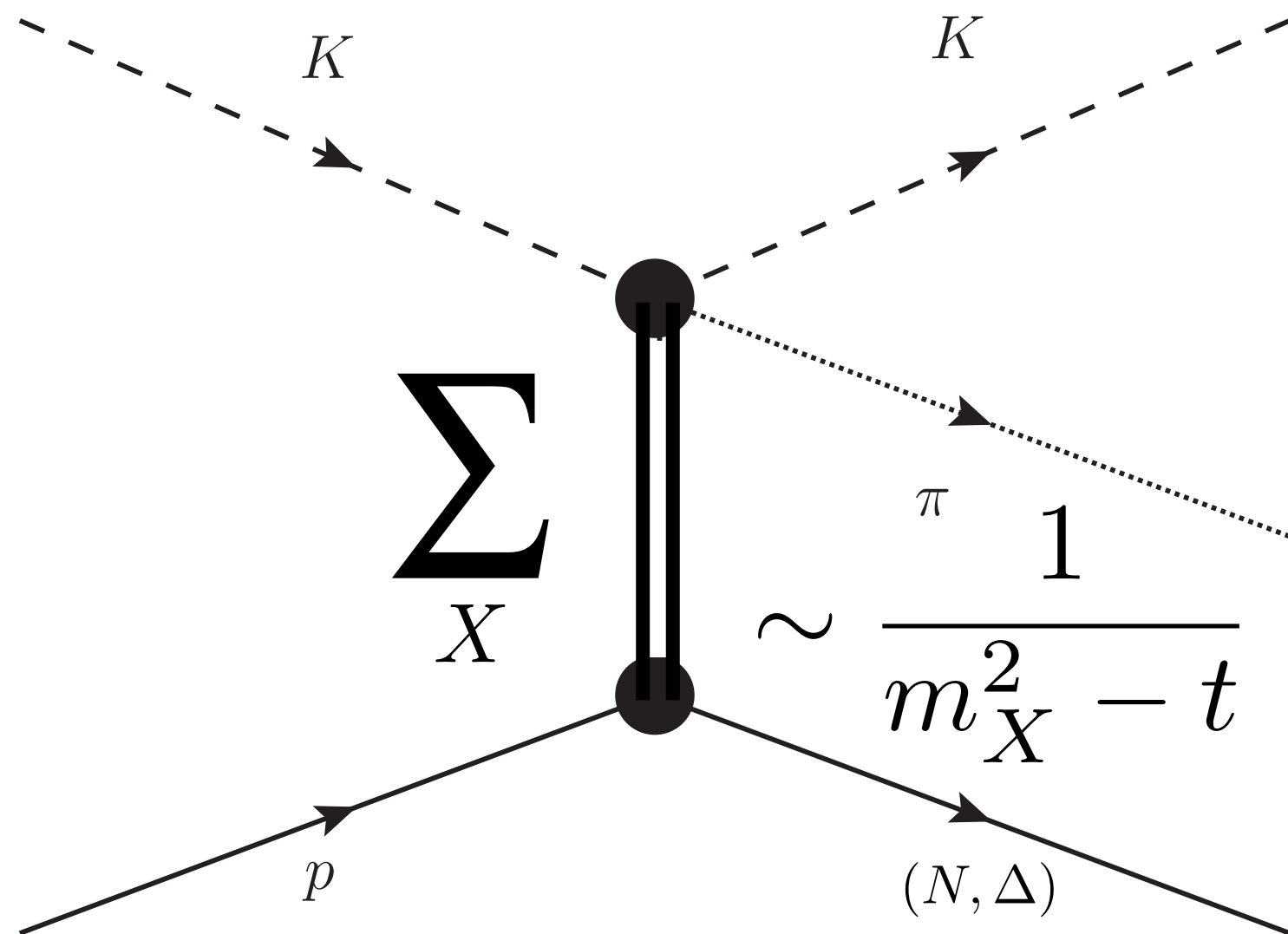

This crude estimation suggests that other exchanges need not be fully negligible with respect to the OPE for large masses

The pion propagator dominates at low t

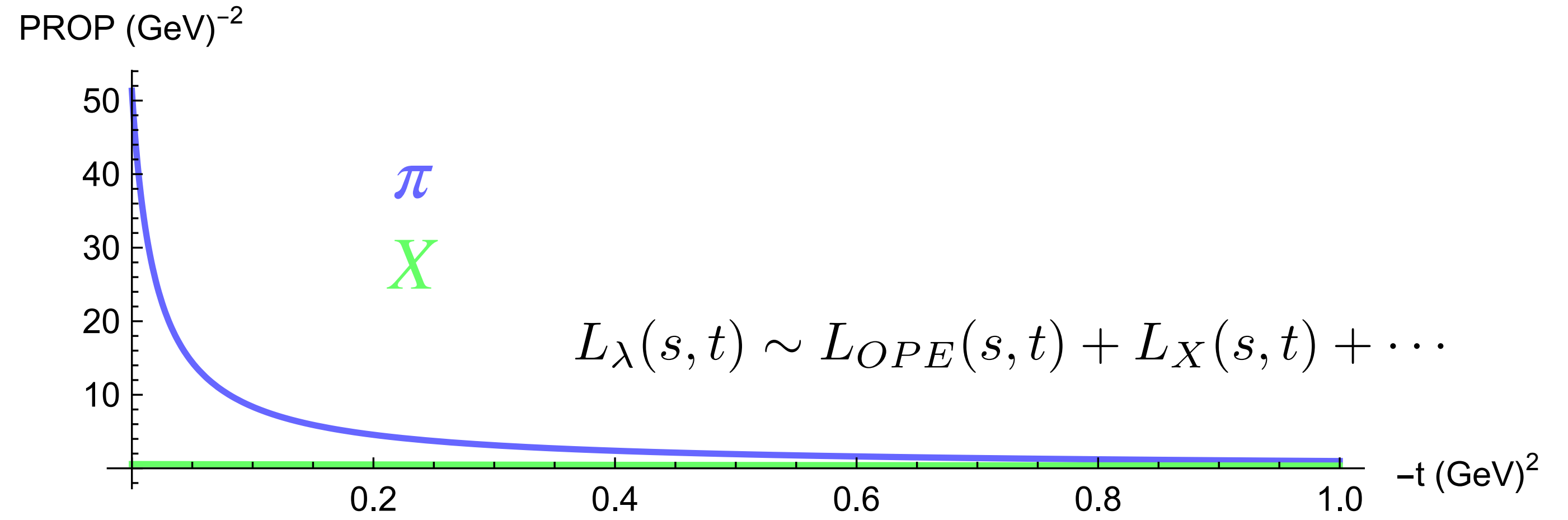

But remember our t_{min} might become large with $m_{\pi K}$

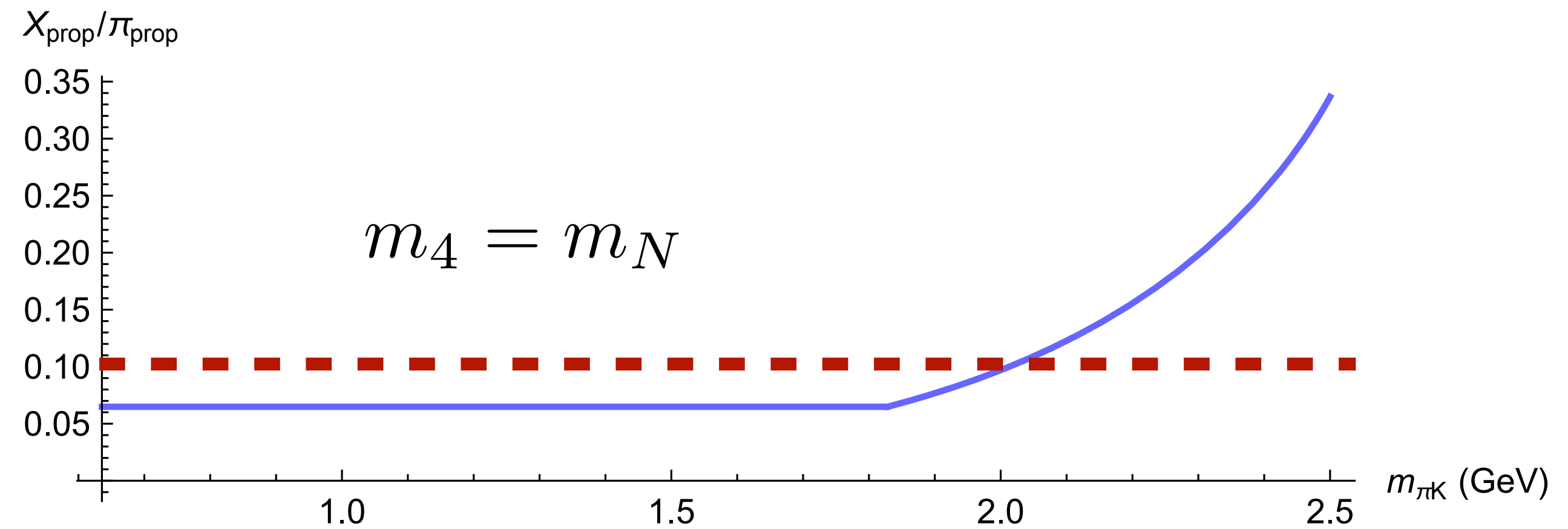

Solutions

Attract theoretical talent/experts on reaction theory/exchanges

Determine other possible exchange(s) with robustness

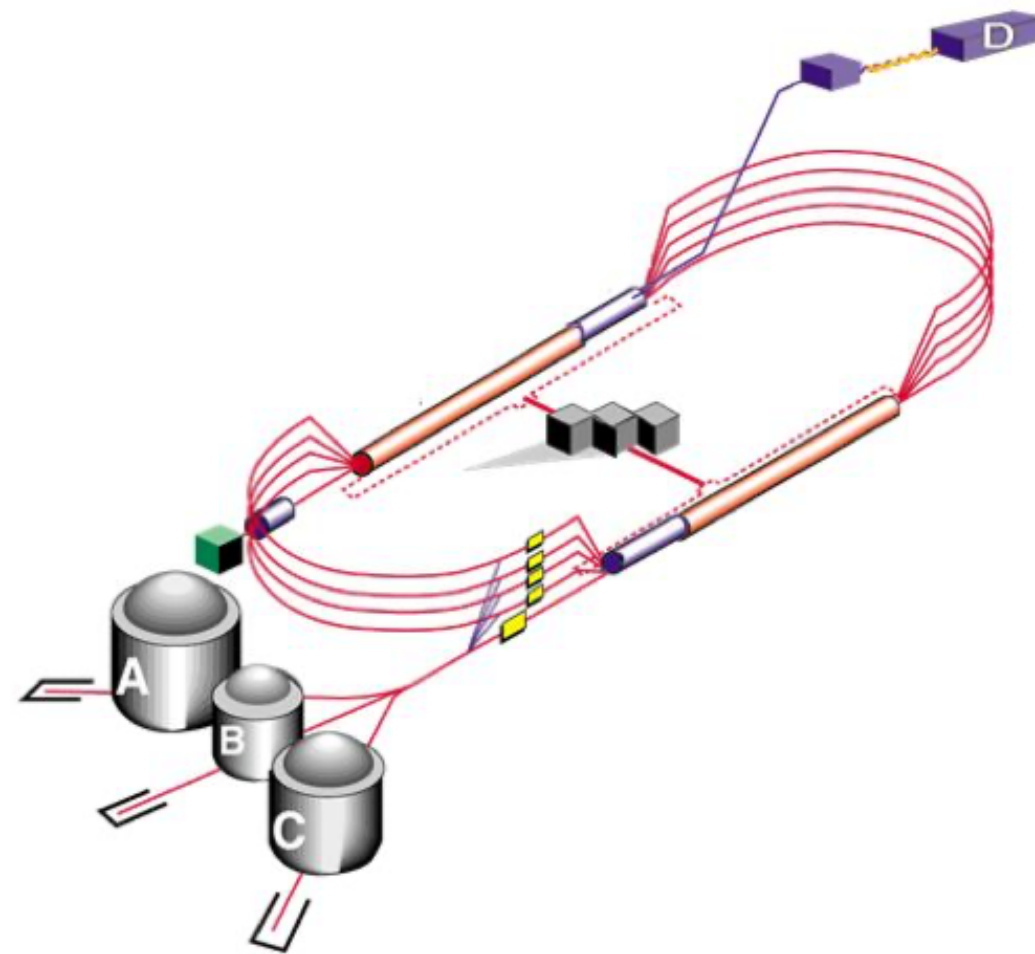
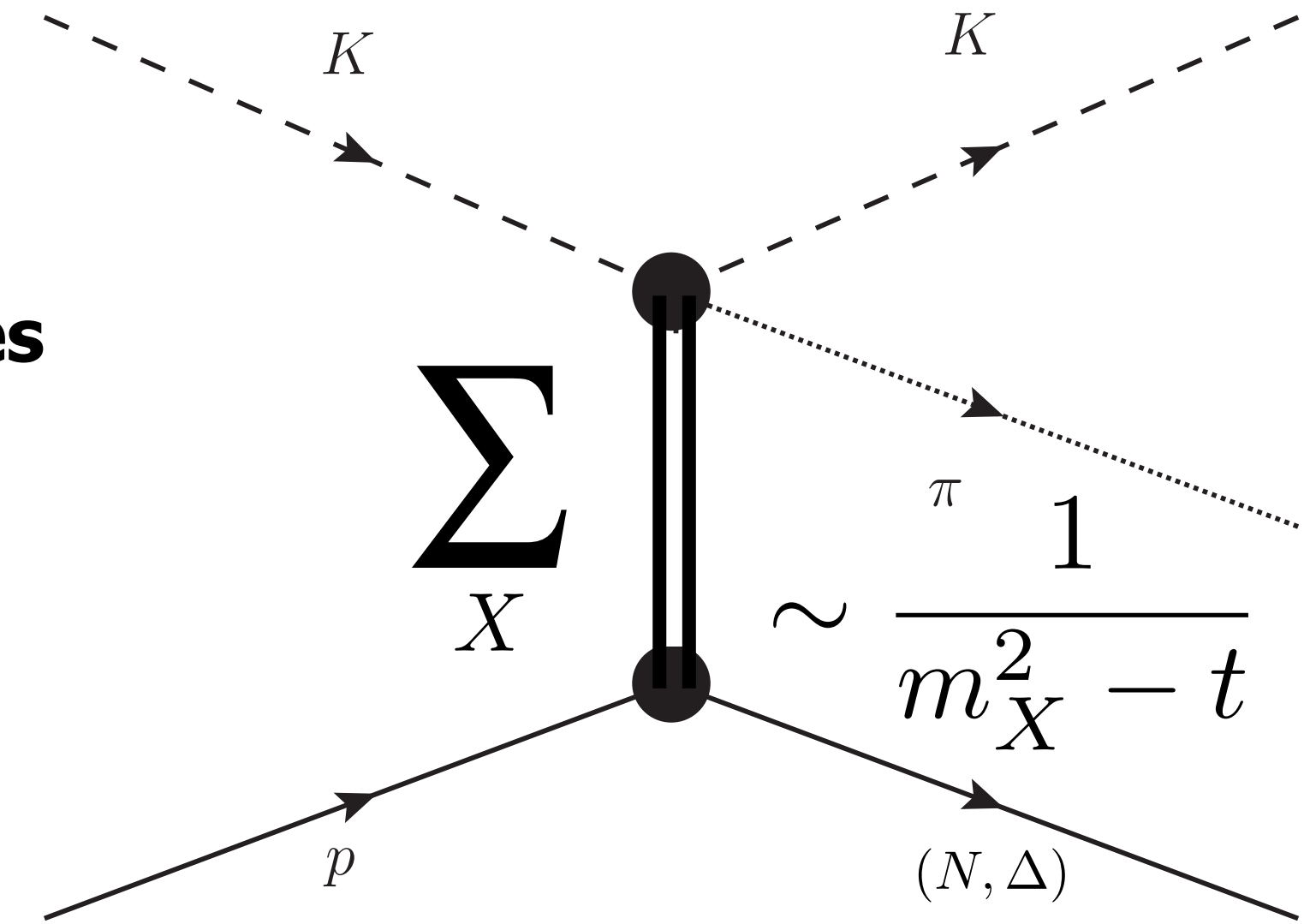

Can polarized targets help separate the exchange contributions?

<https://arxiv.org/pdf/hep-ph/9606362.pdf>

Increase the energy of the Kaon beam

Future upgrade??

Future??

Increase the energy of the Kaon beam

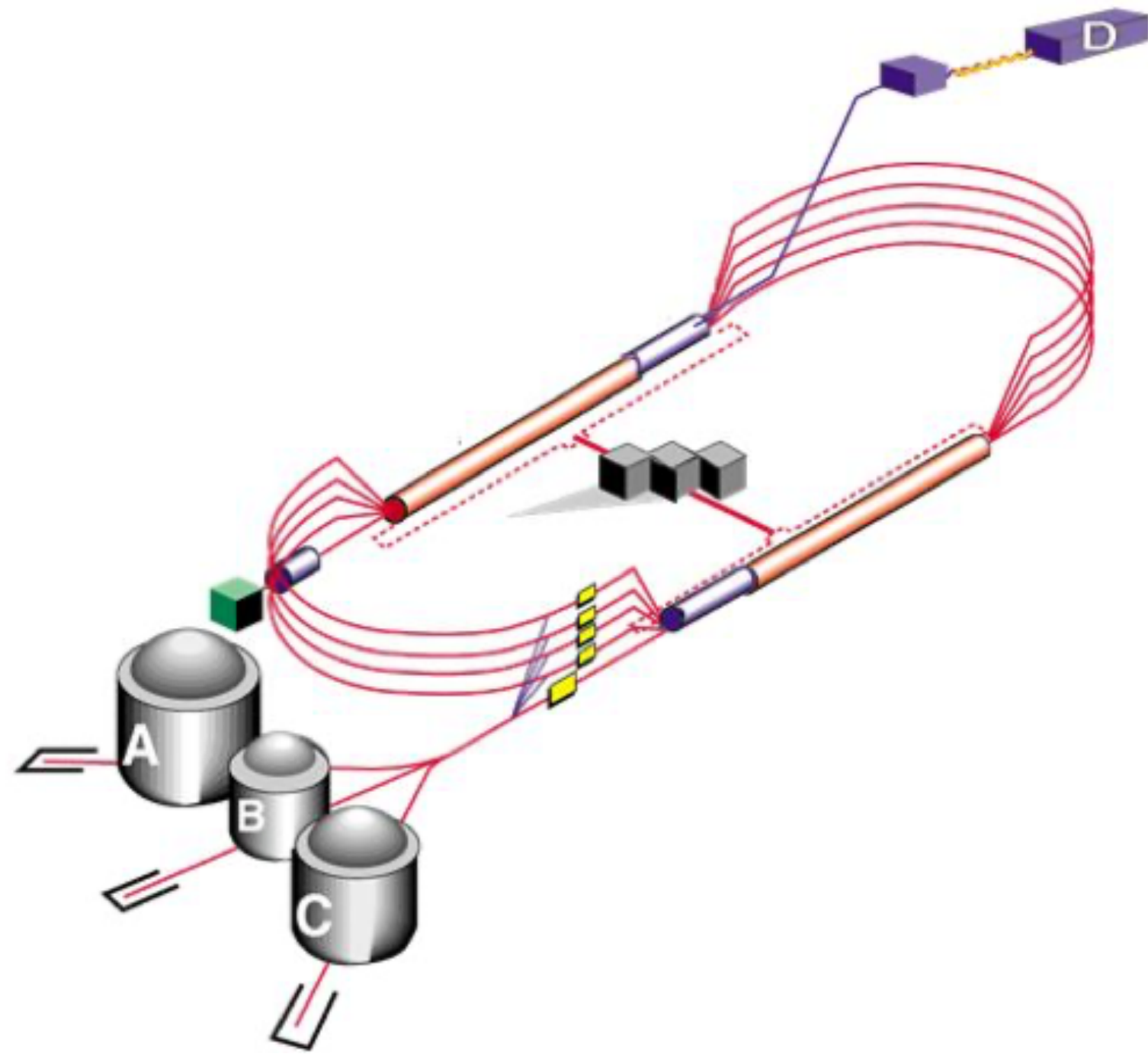

Much smaller t_{min} achievable

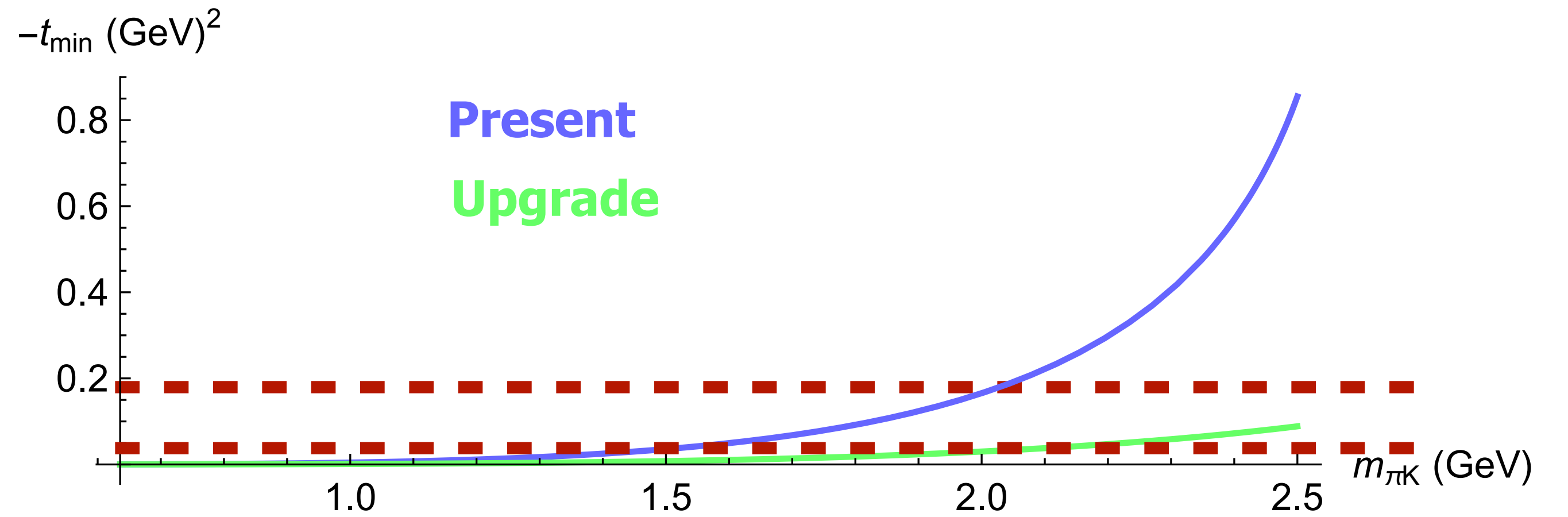

Much smaller contribution from other exchanges

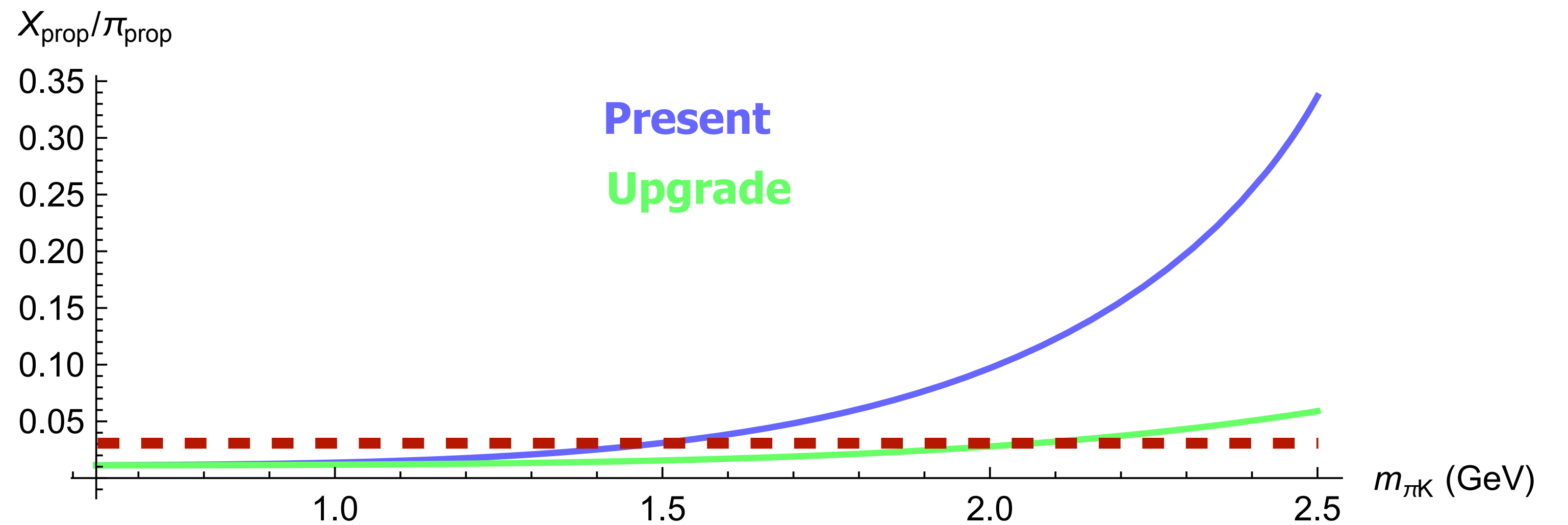

Conclusions

6 out of 10 K^* resonances below or around 2 GeV are poorly known

Related to ChPT, CP-violating decays, B decays, CKM and BSM searches

The setup and current models should work very well at low $m_{\pi K}$

Three possible solutions for tackling the exchanges at high $m_{\pi K}$:

- 1. Elaborate theoretical input**
- 2. Could polarized targets help factorize the exchanges?**
- 3. Future JLab upgrade**

Thank you!!

Challenge II

Not all t values are reachable

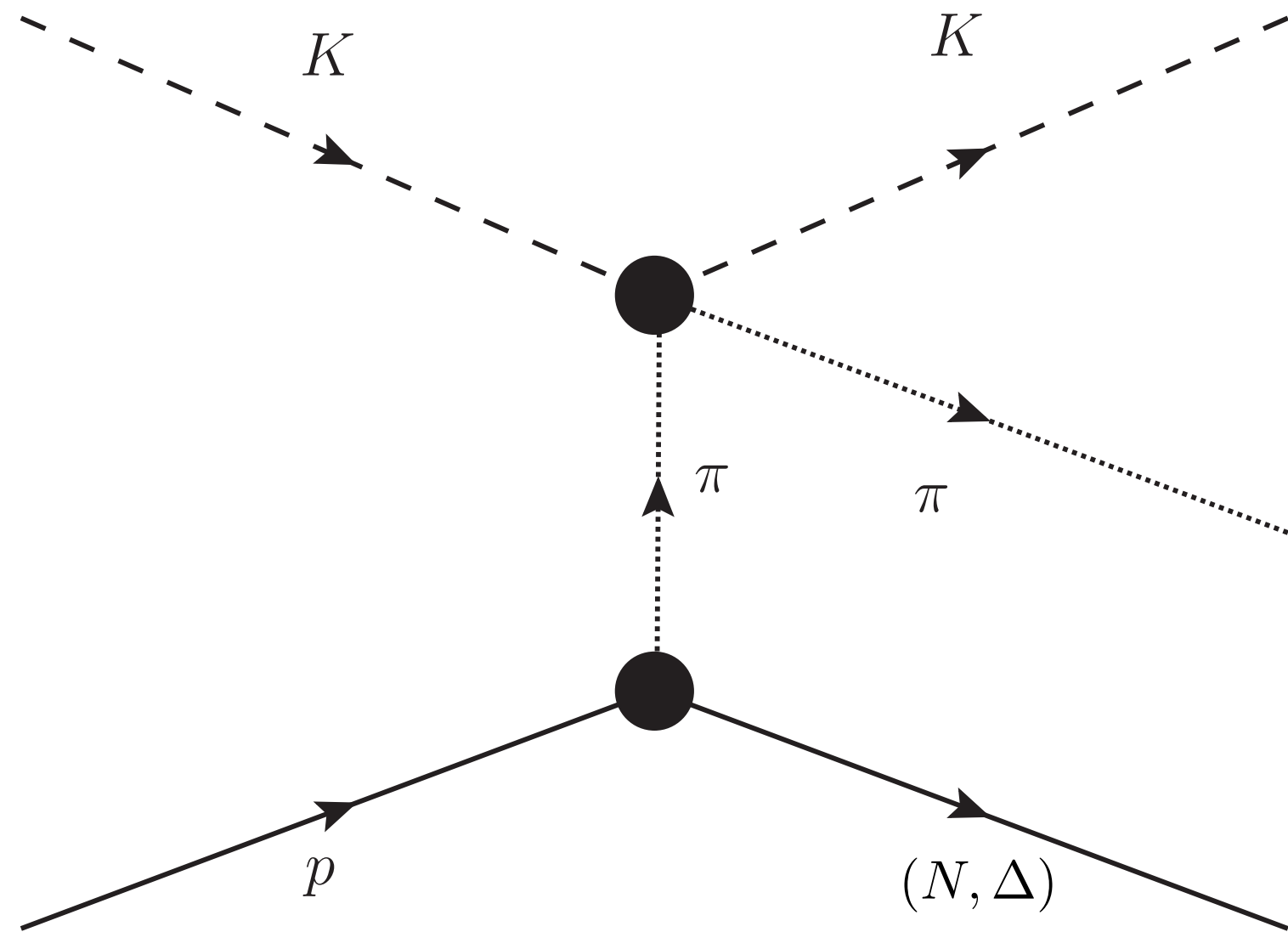

Not all theoretically reachable t values are measurable in practice

Largest resonance mass

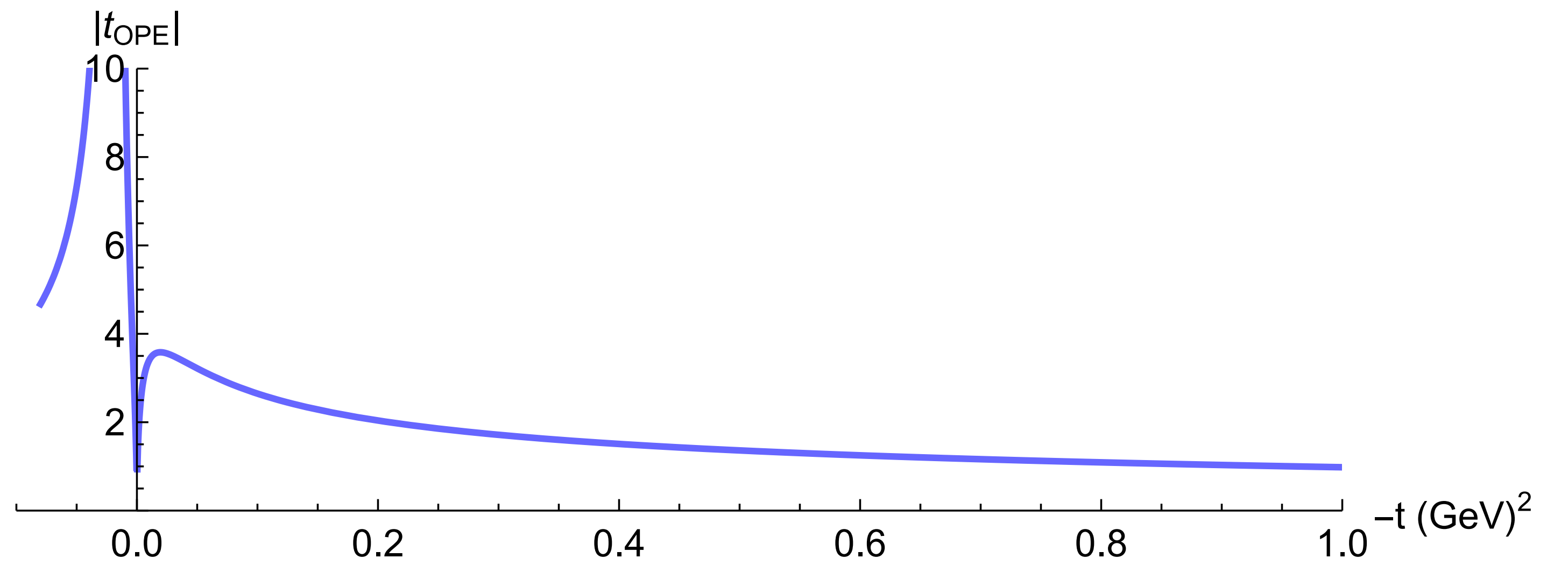

$$t_{min}(s') = \left[\frac{m_K^2 - m_{\pi K}^2 - m_N^2 + m_{(N,\Delta)}^2}{2\sqrt{s'}} \right]^2 - (p_{1 \text{ cm}}(s') - p_{3 \text{ cm}}(s'))^2$$

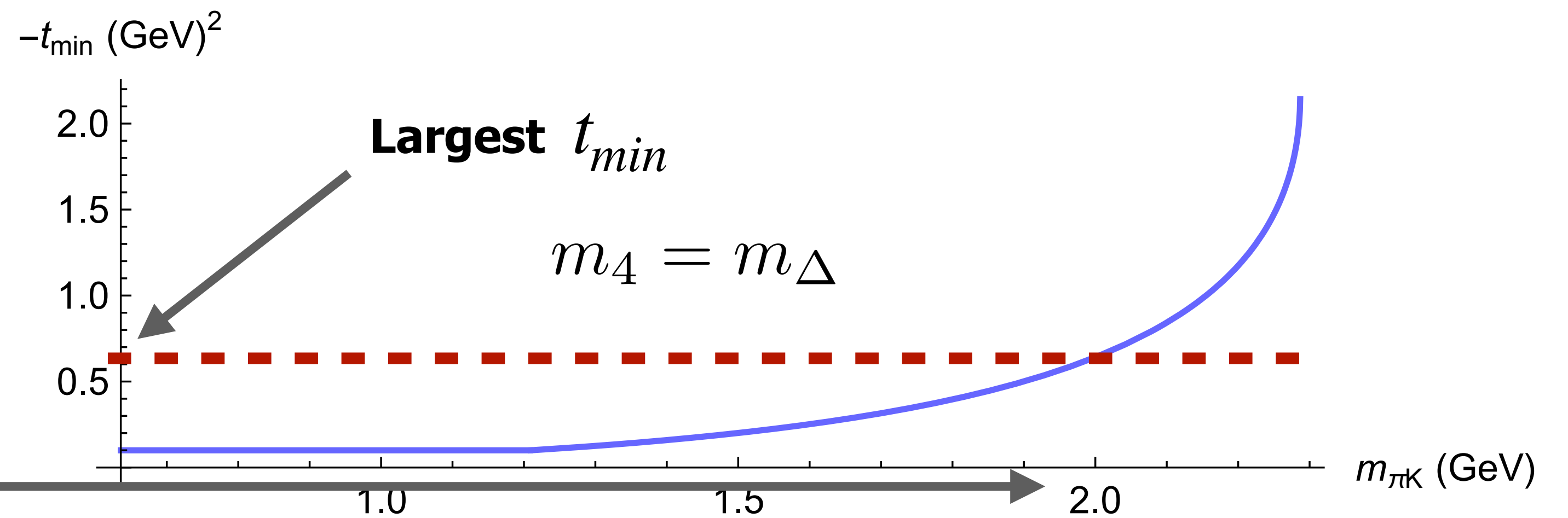

Isospin separation

We can measure different isospin combinations

$$L_0(s, t) \sim f_L(s) \frac{\sqrt{-t}}{m_\pi^2 - t}$$

$$f_L(s) = x f_{1/2}(s) + y f_{3/2}(s)$$

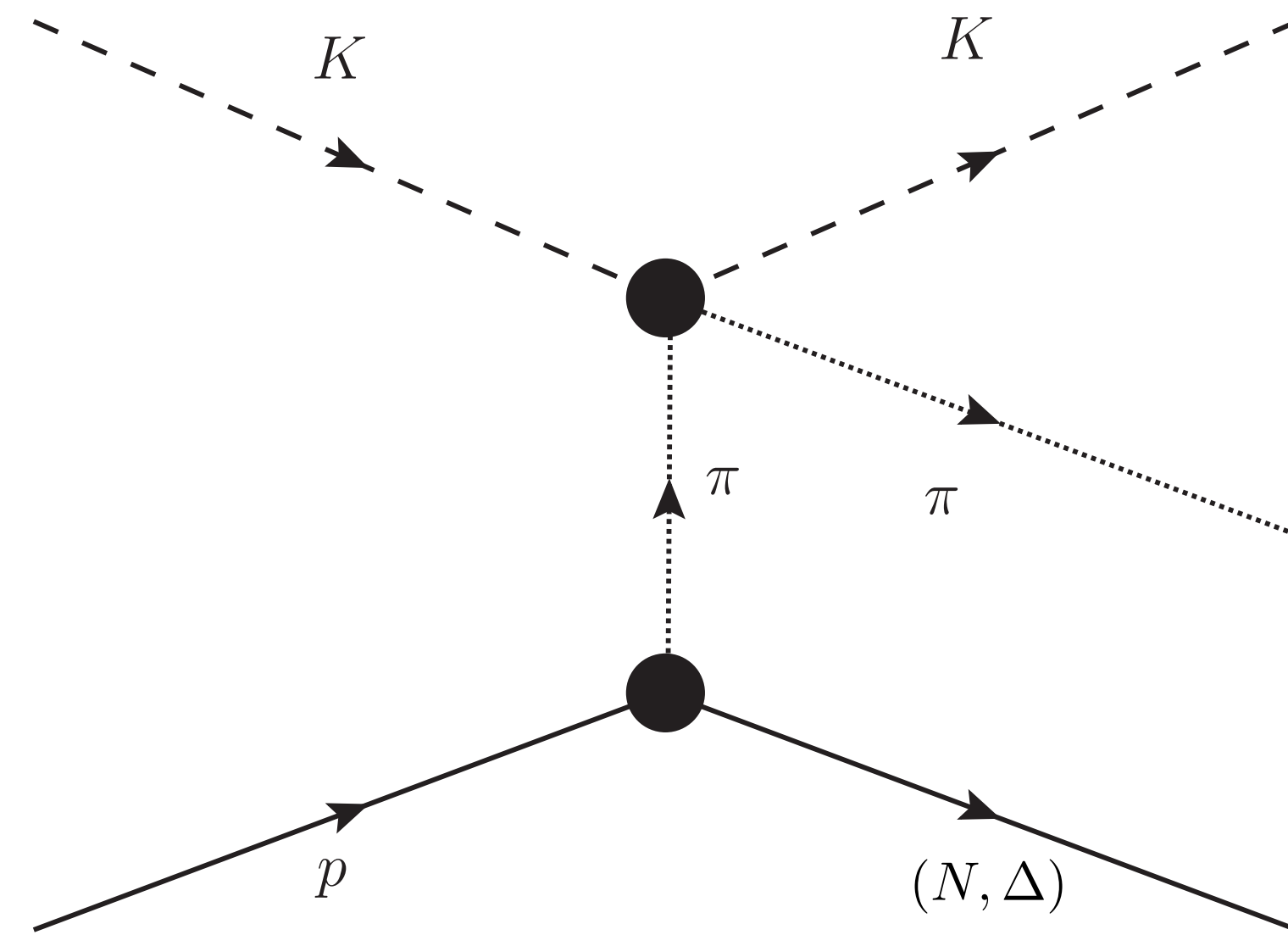

To separate $I = 1/2, 3/2$ we need to measure at least a final state with K_L

$$KL\pi^+ \rightarrow KL\pi^+ : \frac{a^2}{3} + \frac{2b^2}{3}$$

$$KL\pi^+ \rightarrow KS\pi^+ : \frac{a^2}{3} - \frac{b^2}{3}$$

$$KL\pi^+ \rightarrow K^+\pi^0 : -\frac{a^2}{3} + \frac{b^2}{3}$$

$$KL\pi^0 \rightarrow KL\pi^0 : \frac{a^2}{3} + \frac{2b^2}{3}$$

$$KL\pi^0 \rightarrow K^+\pi^- : -\frac{a^2}{3} + \frac{b^2}{3}$$

$$KL\pi^0 \rightarrow K^-\pi^+ : -\frac{a^2}{3} + \frac{b^2}{3}$$

$$KL\pi^- \rightarrow KL\pi^- : \frac{a^2}{3} + \frac{2b^2}{3}$$

$$KL\pi^- \rightarrow KS\pi^- : -\frac{a^2}{3} + \frac{b^2}{3}$$

$$KL\pi^- \rightarrow K^-\pi^0 : -\frac{a^2}{3} + \frac{b^2}{3}$$

Challenge II

We exchange more than pions

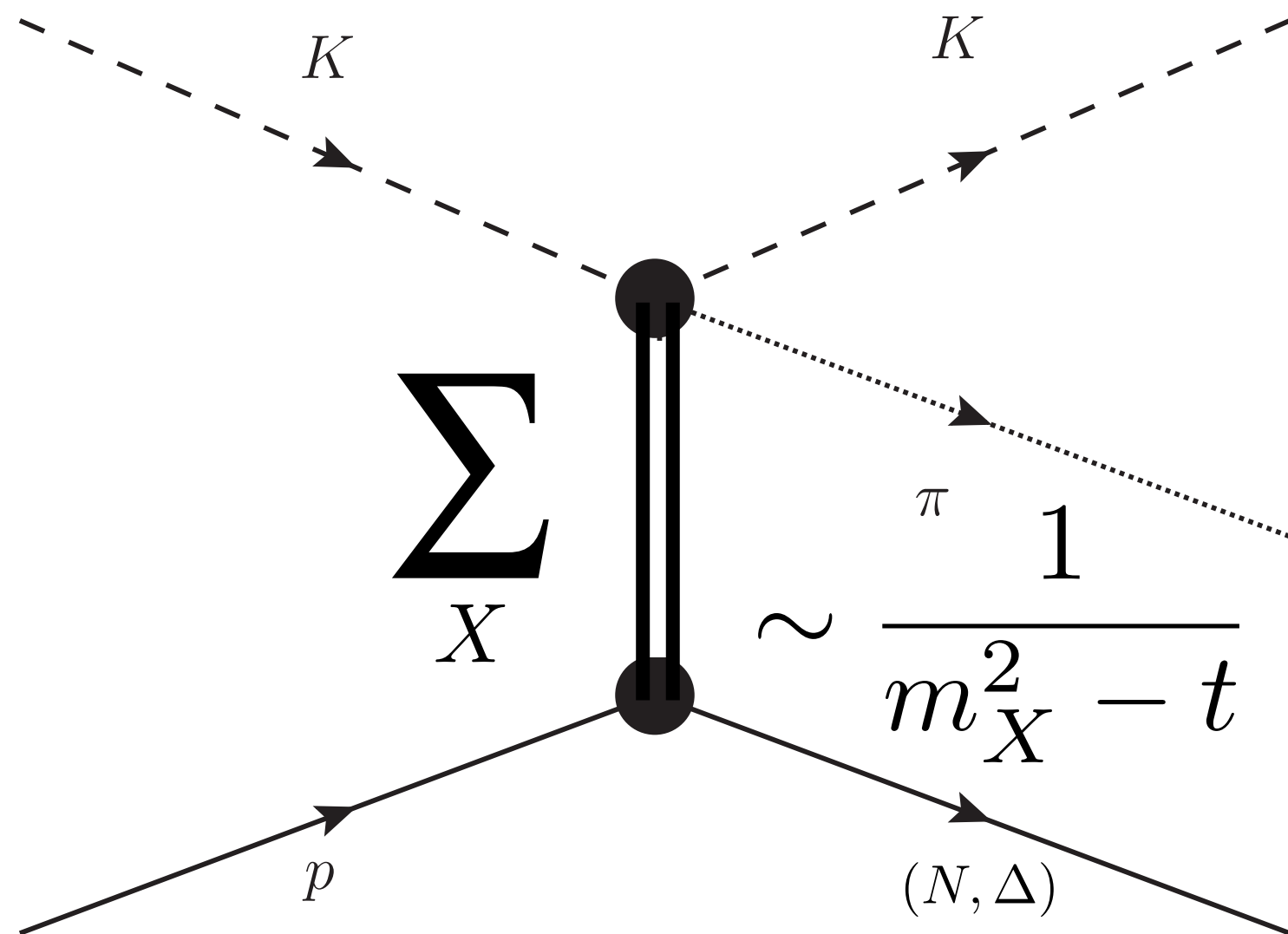

This, very crude, pessimistic estimation suggests that other exchanges need not be negligible with respect to the OPE for large masses

The pion propagator dominates at low t

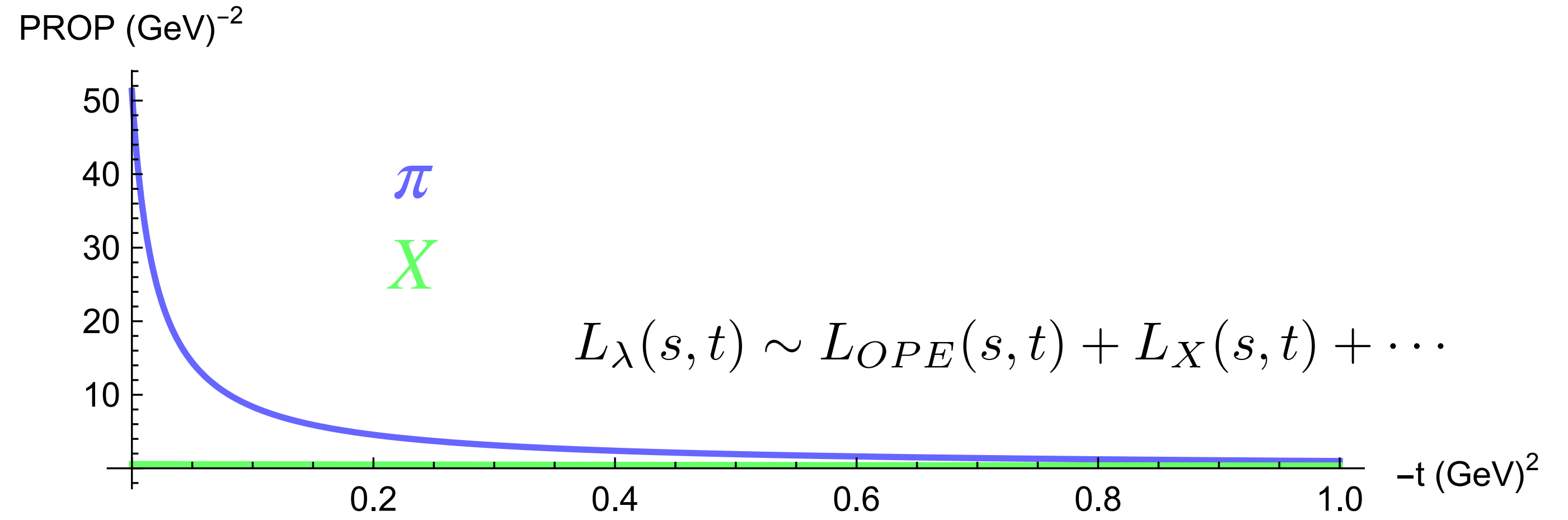

But remember our t_{min} might become large with $m_{\pi K}$

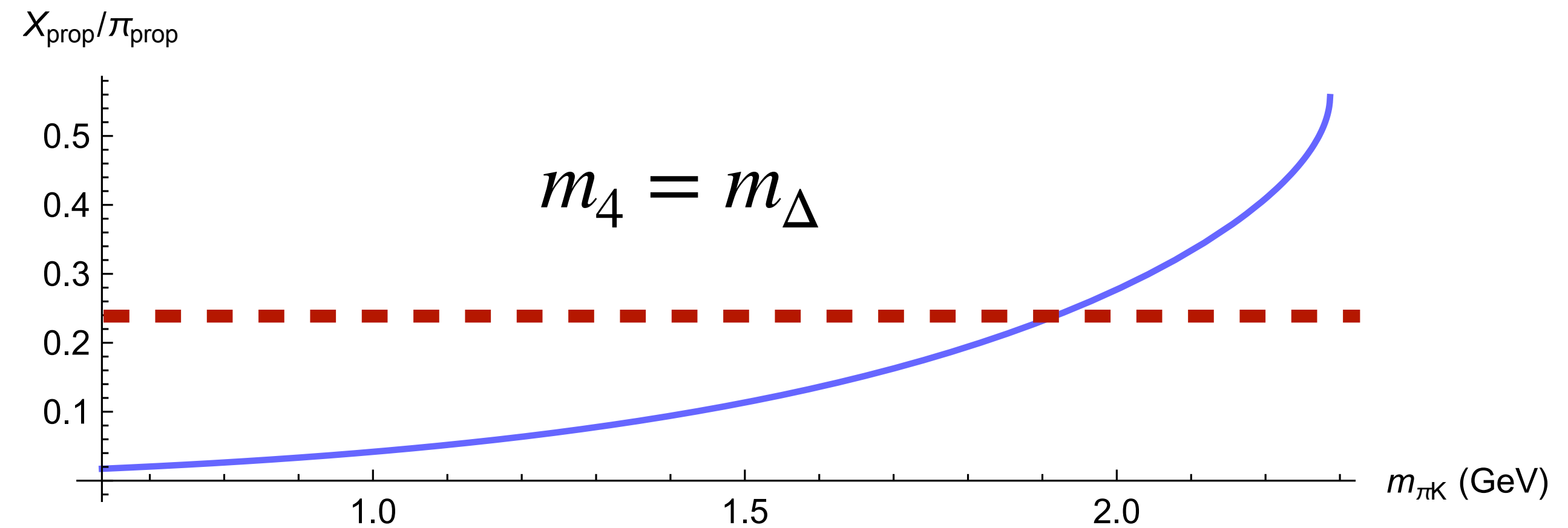

Future??

Increase the energy of the Kaon beam

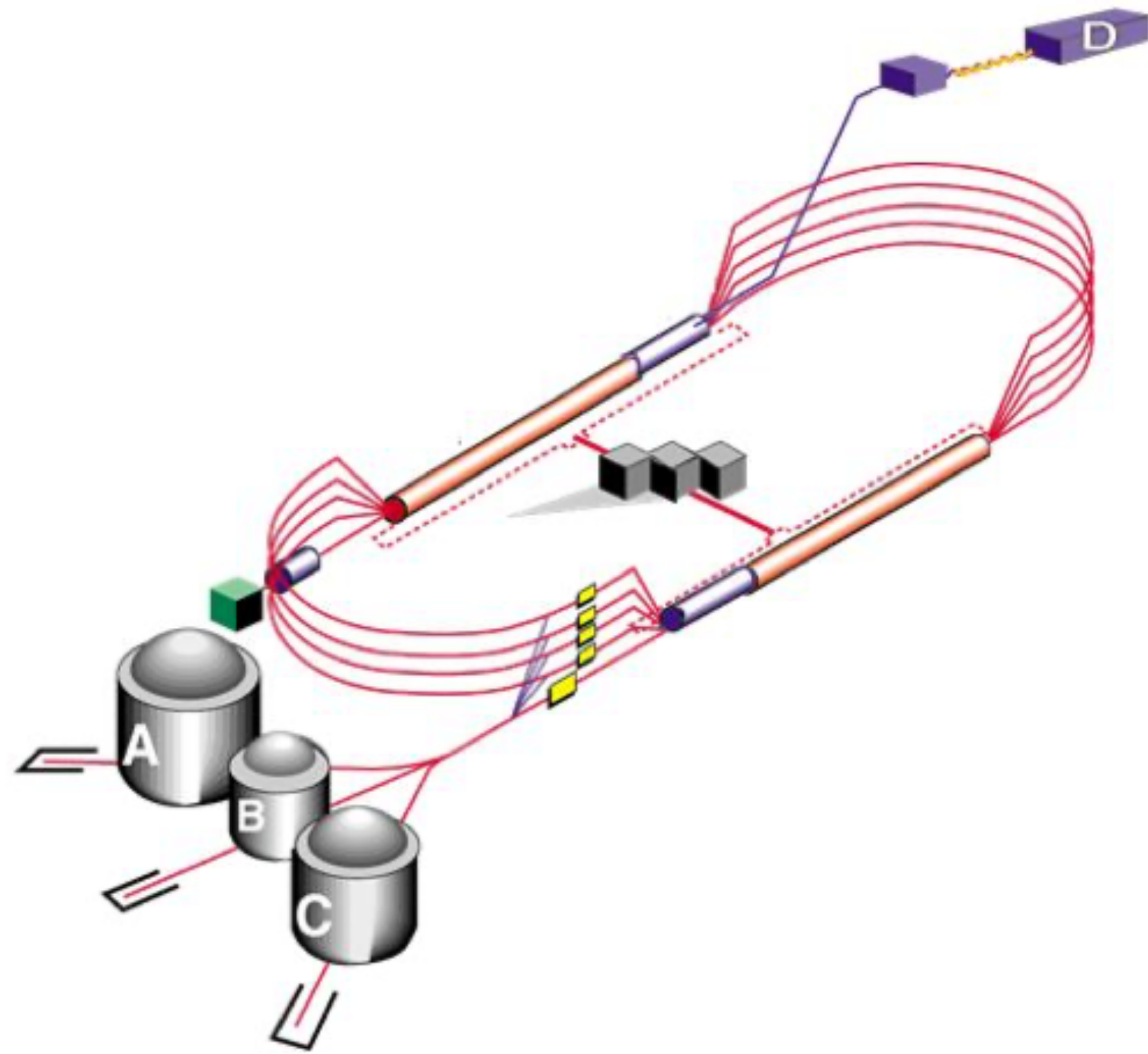

Much smaller t_{min} achievable

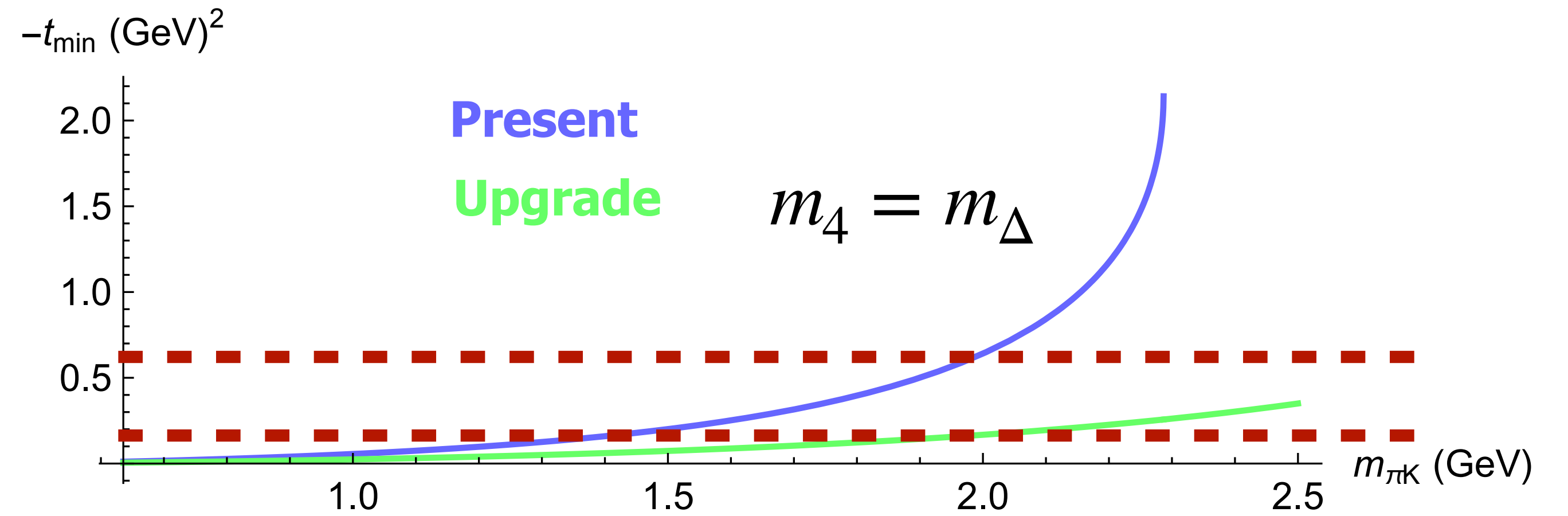

Much smaller contribution from other exchanges

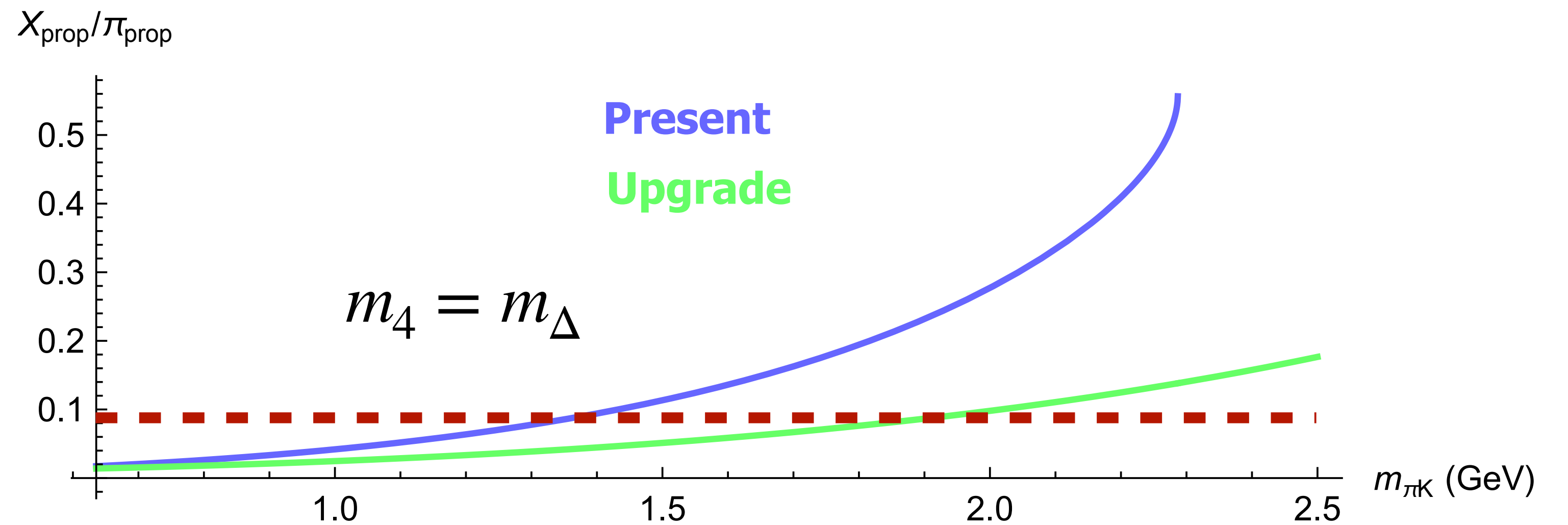

Scattering

Definitely not a BW

$$t_\ell(s) \sim ??$$

What's this??

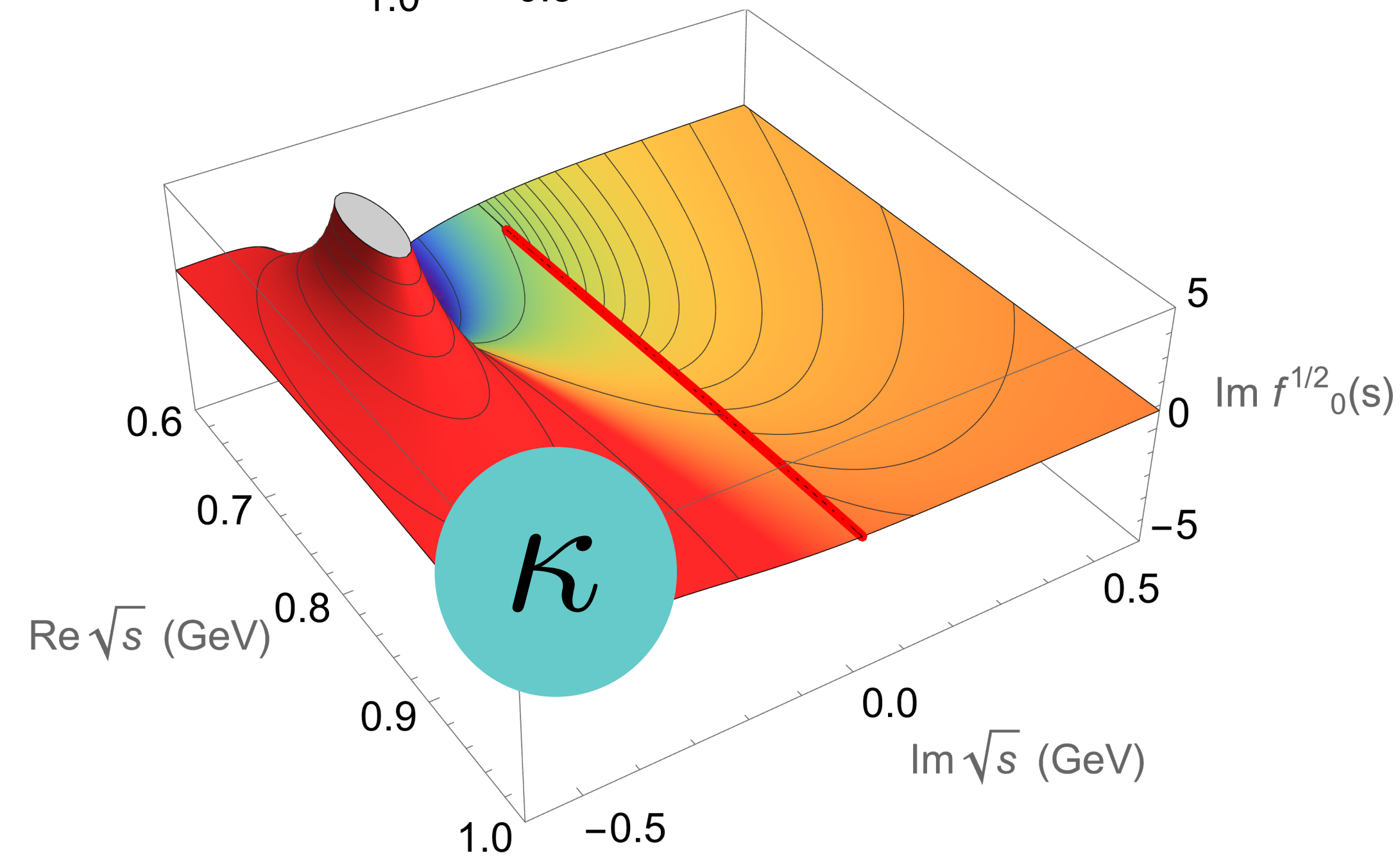
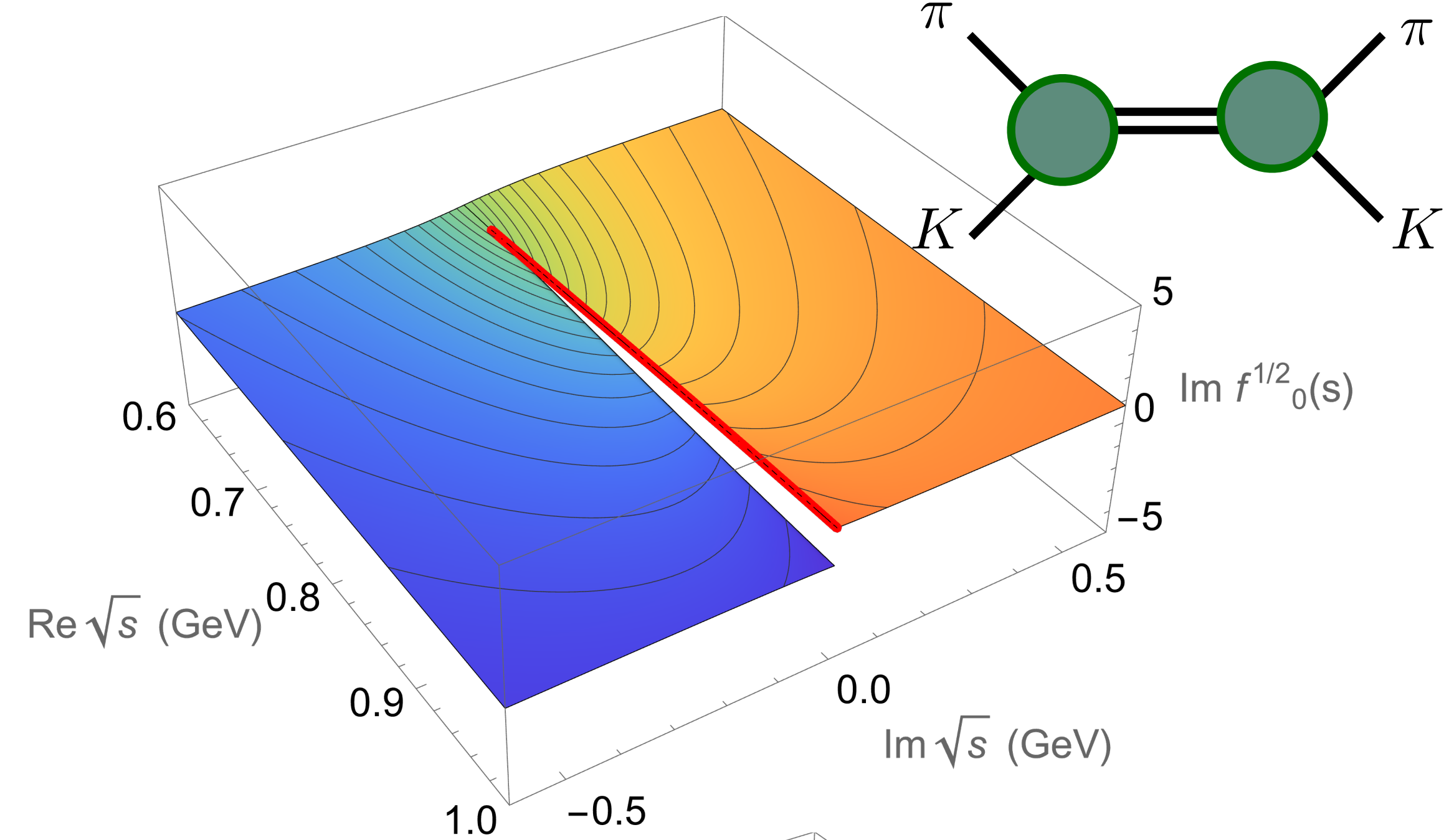
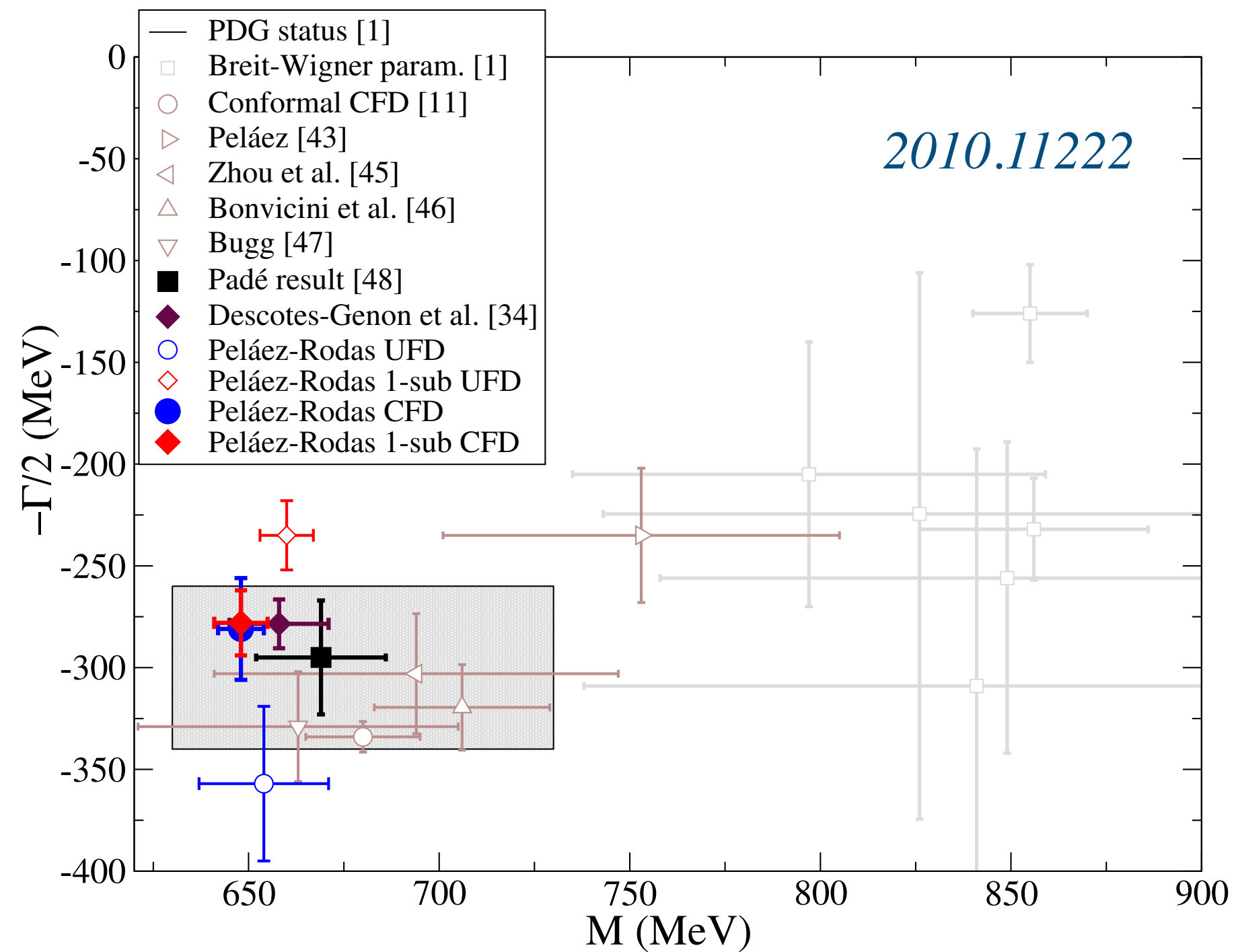

Scattering

Definitely not a BW

$$t_\ell(s) \sim ??$$

“We are beginning to think that κ should be classified along with flying saucers, the Loch Ness Monster, and the Abominable Snowman”

PDG 1967

What's this??

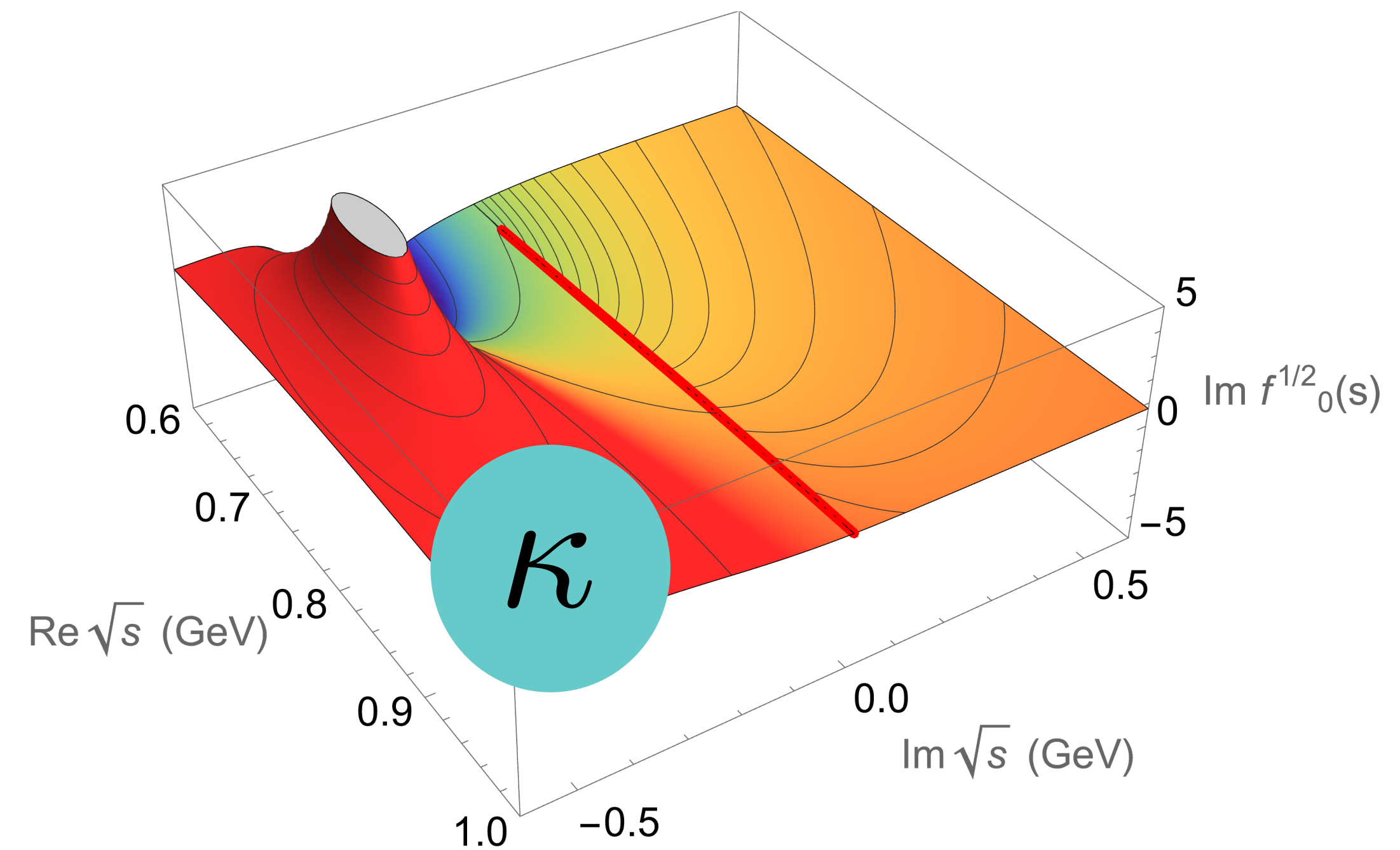
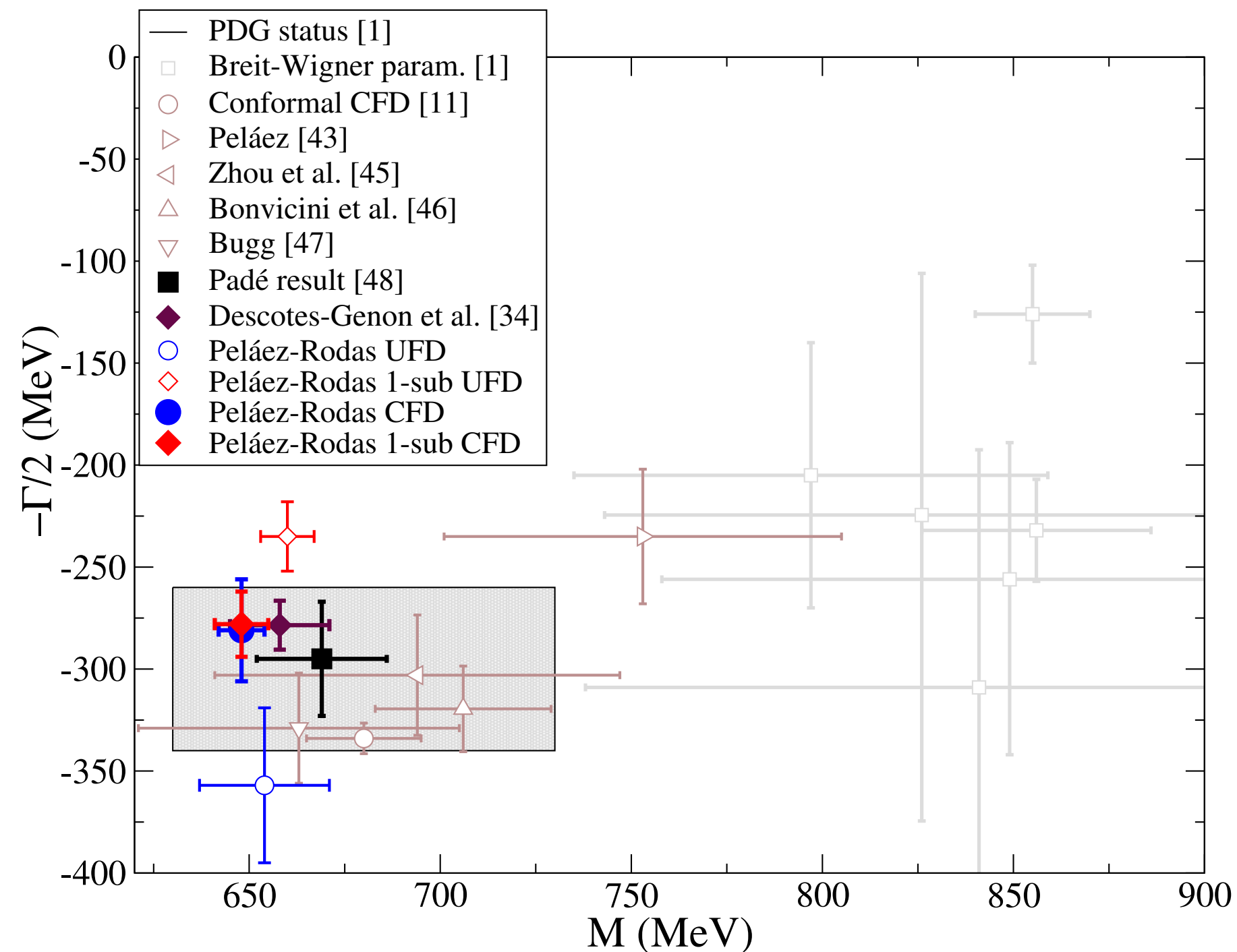

$\pi\pi$ scattering

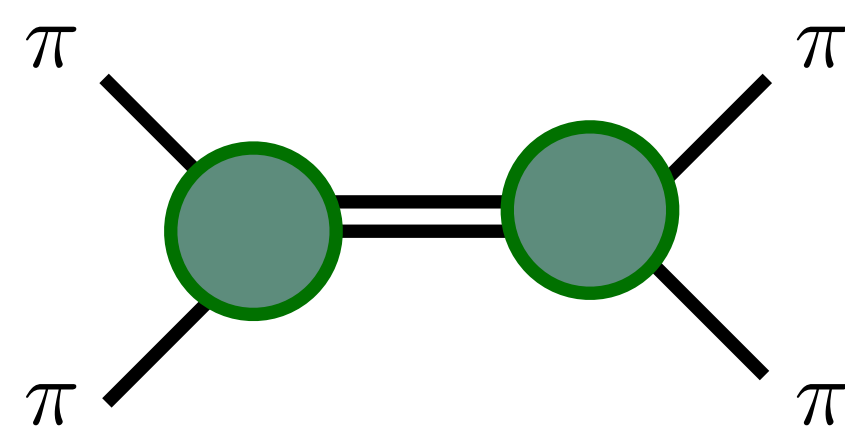
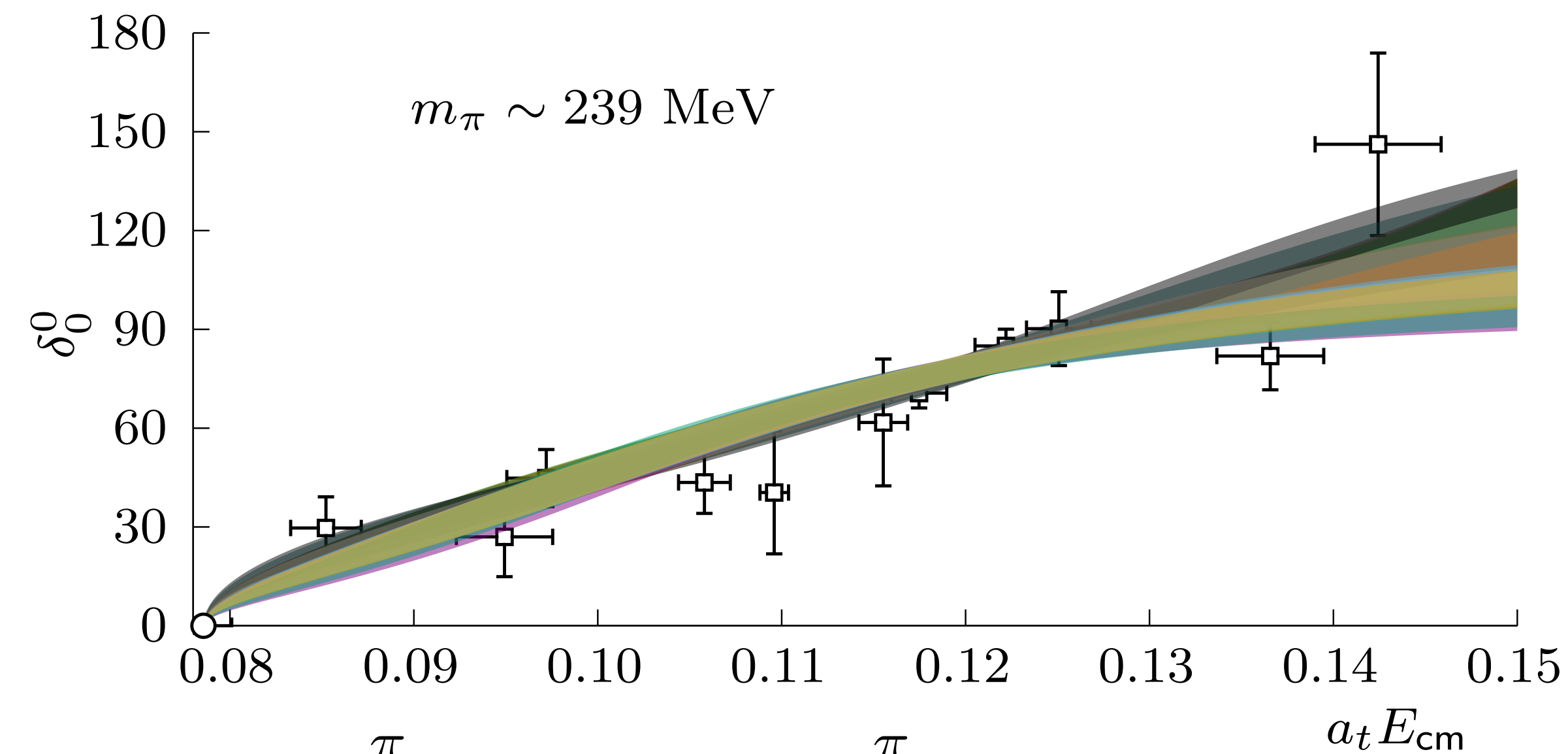

JRP talk

Problem shared with ALL Lattice QCD calculations

Innocent-looking data, around 20 compatible line shapes

The pole positions are not compatible

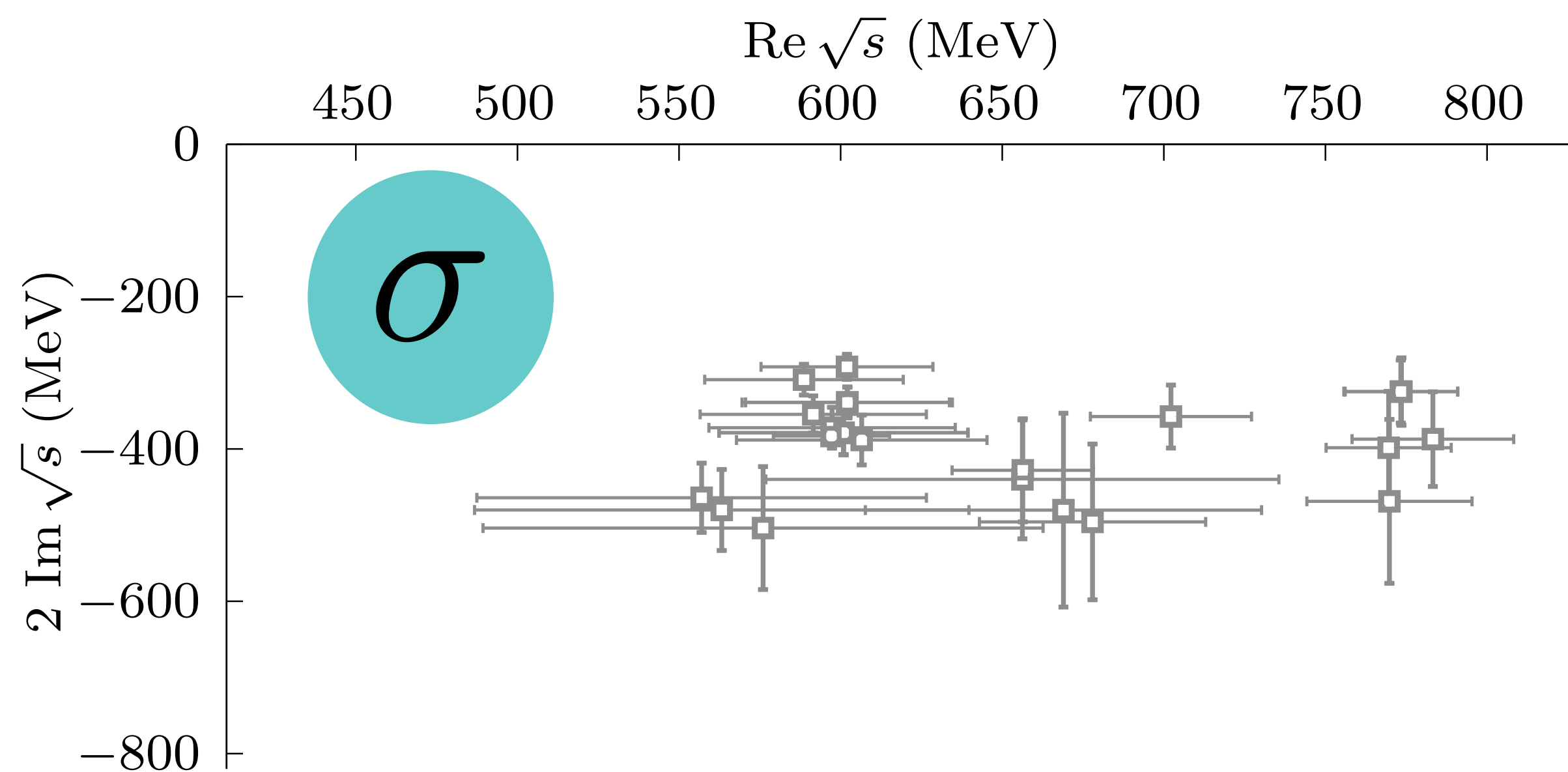

Light Scalars

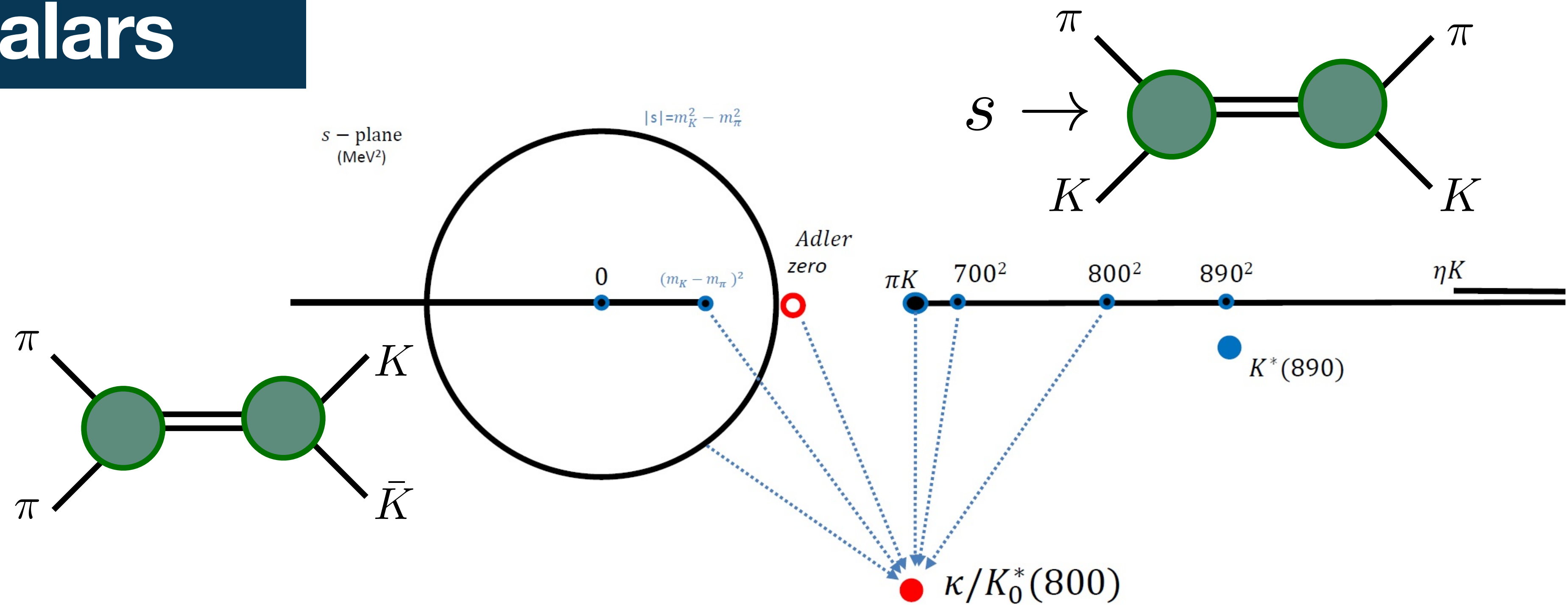

Pole position depends on many structures

Data on the right-hand cut (RHC) \leftrightarrow Unitarity

Low energy expansion

Adler Zero

Left-hand cut

Light Scalars

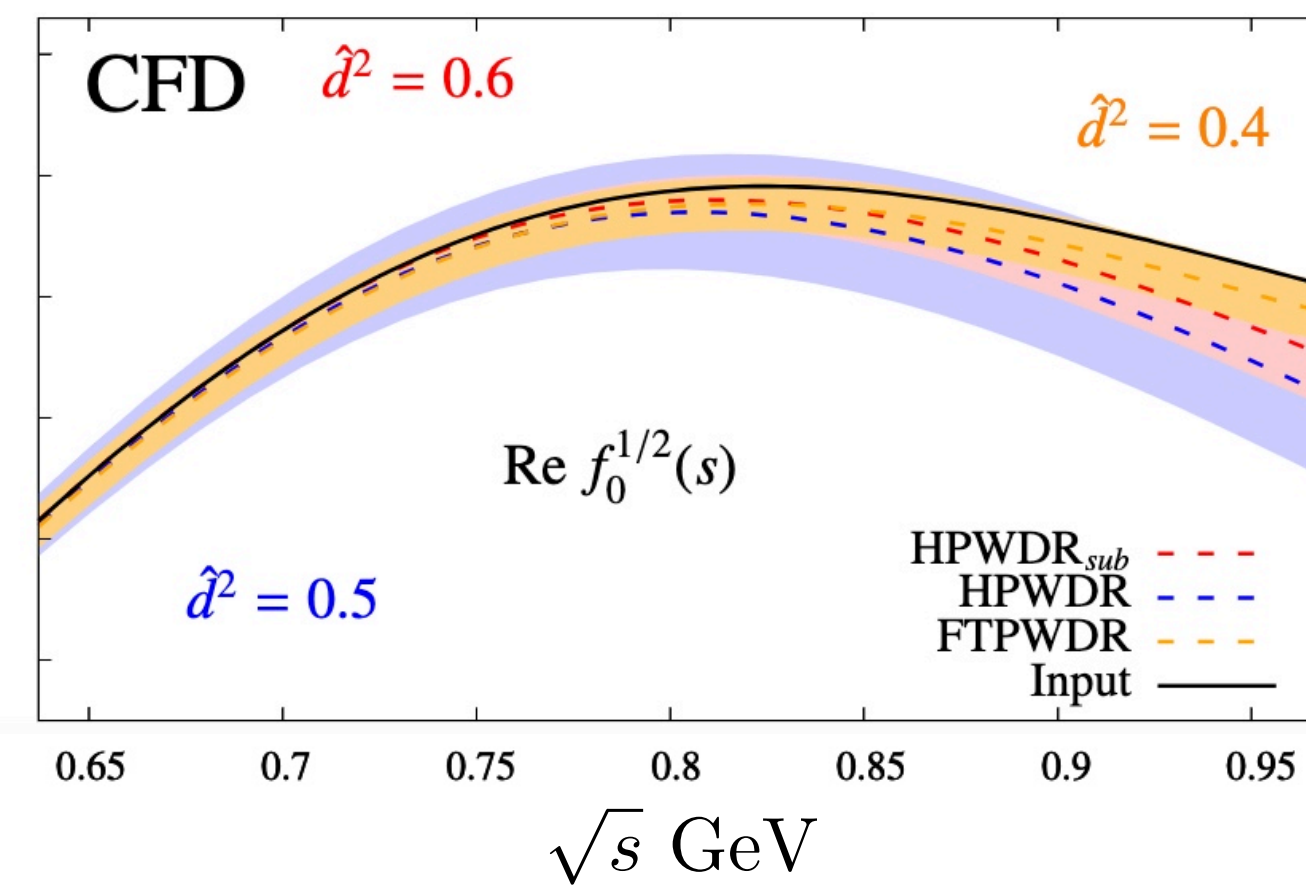
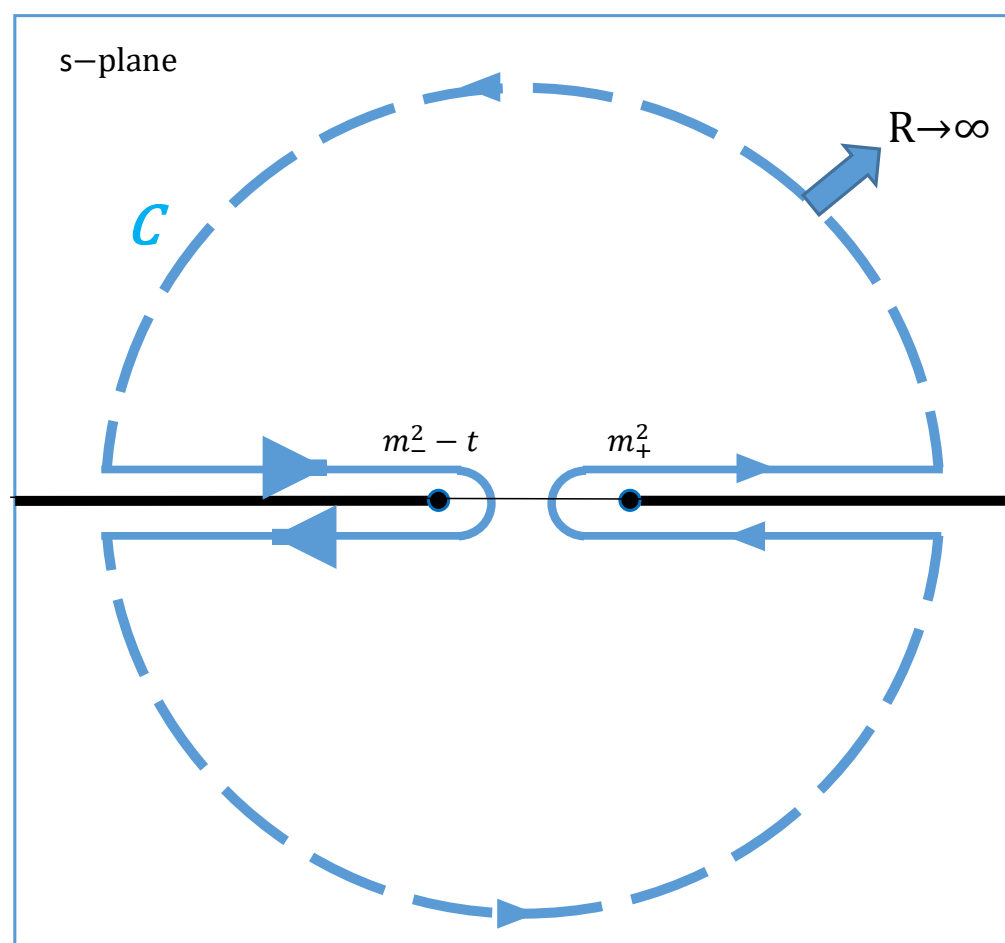
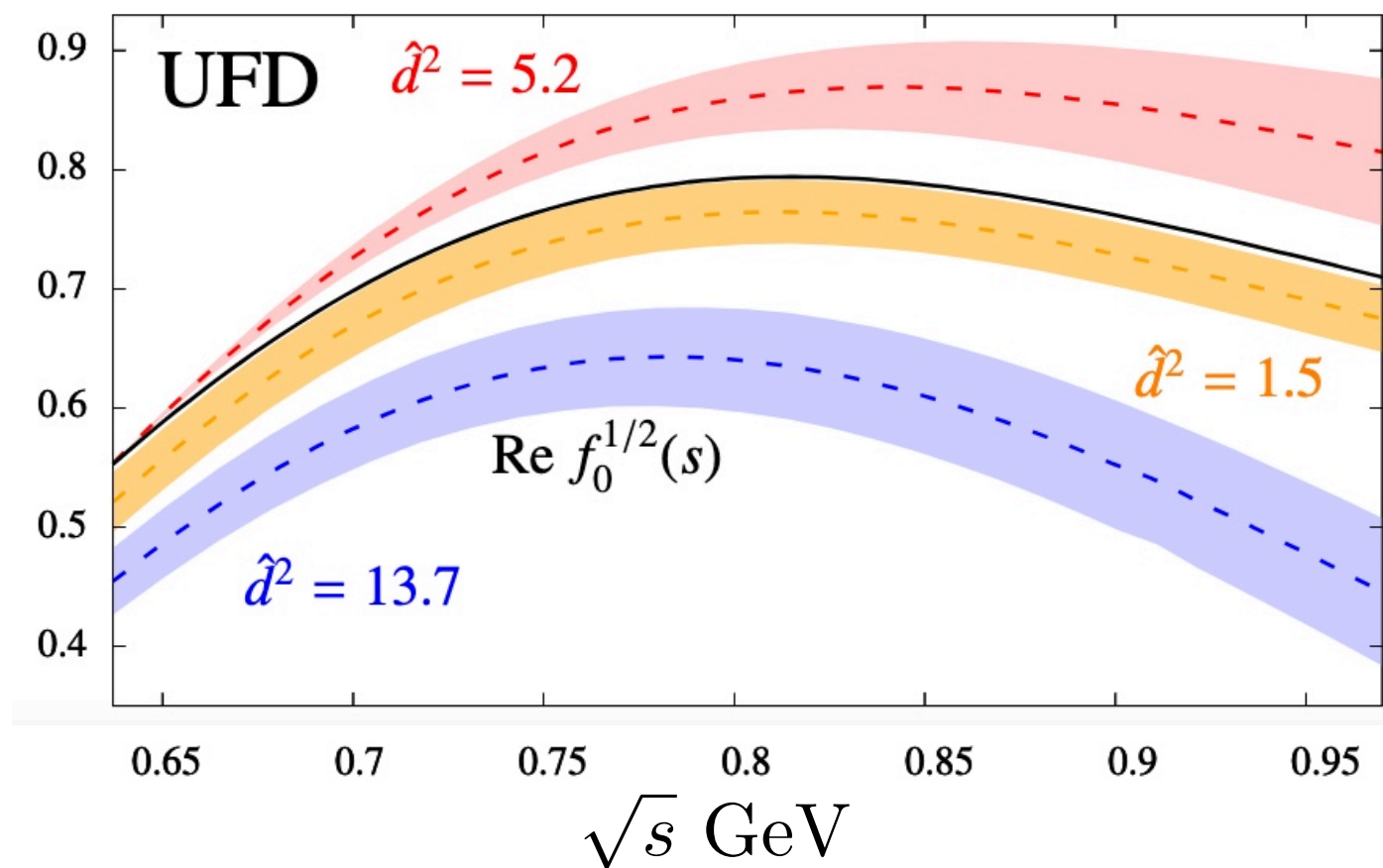

We use the result of these integral equations to extract our poles

$$t(z) = \oint_C \frac{t(z')}{z' - z} dz'$$

The \mathcal{K} has just been recently accepted

“ \mathcal{K} accepted”
PDG

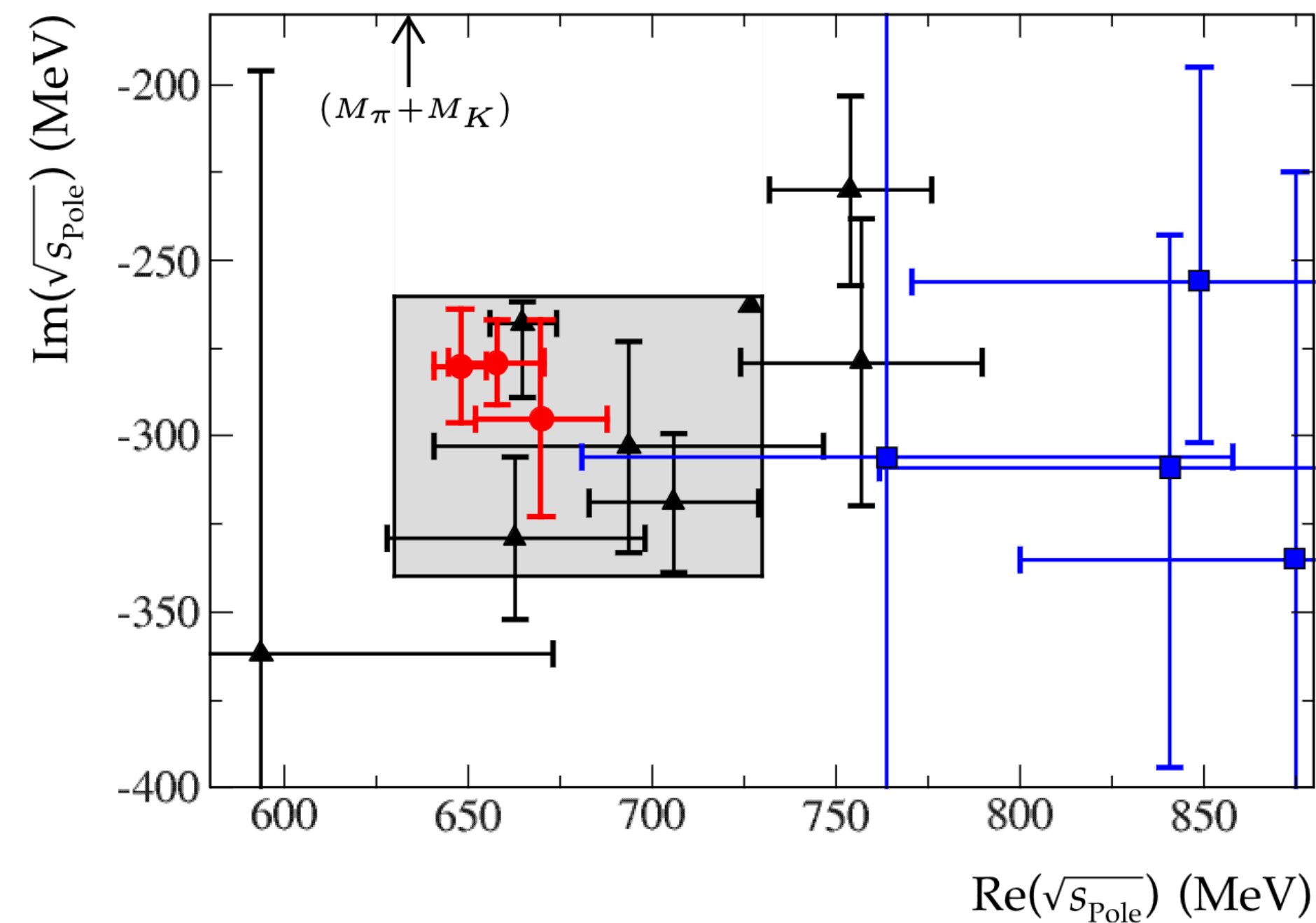

πK scattering



Make

Fit \rightarrow *In*

DR \rightarrow *Out*

compatible

Vary the fits a bit

$f_l^I(s)$

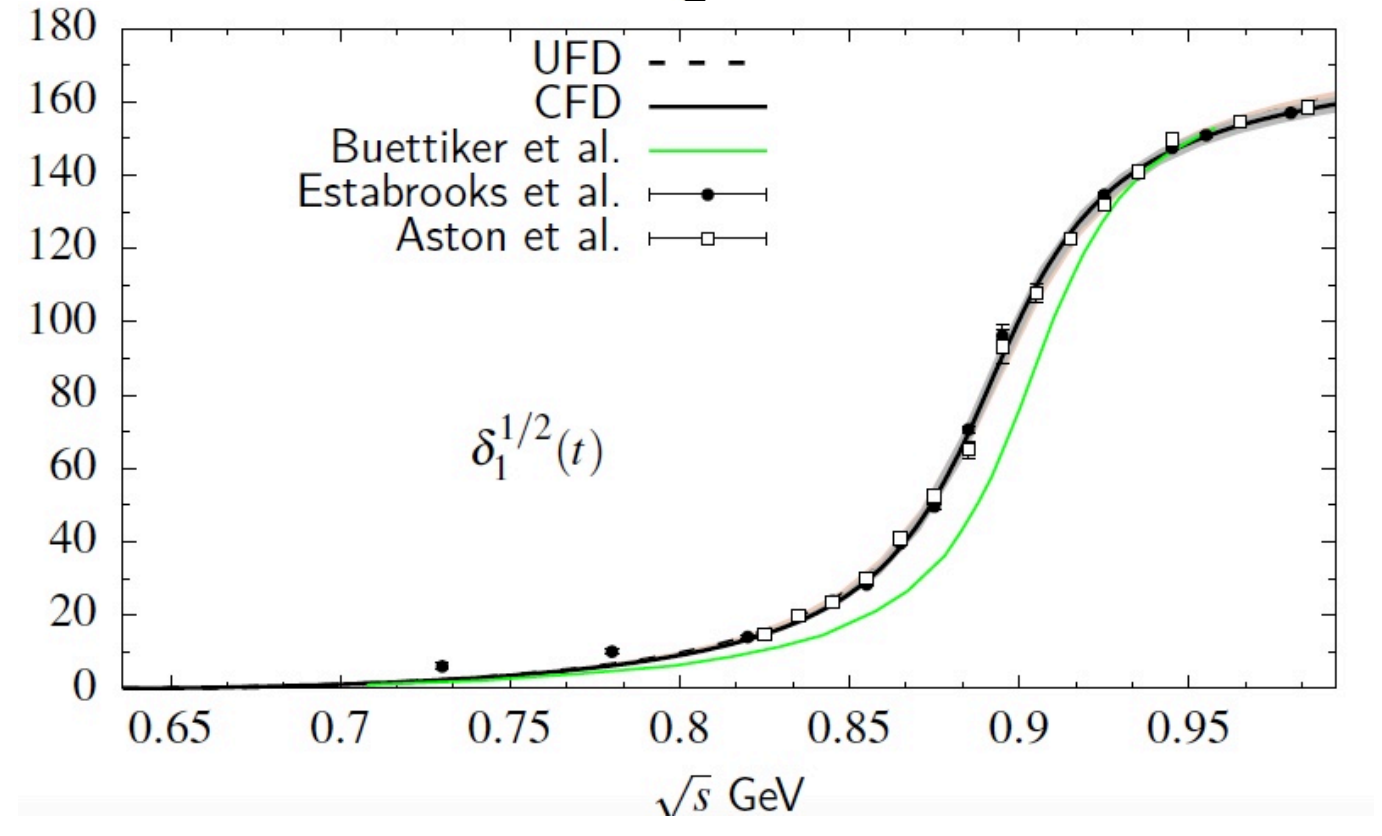
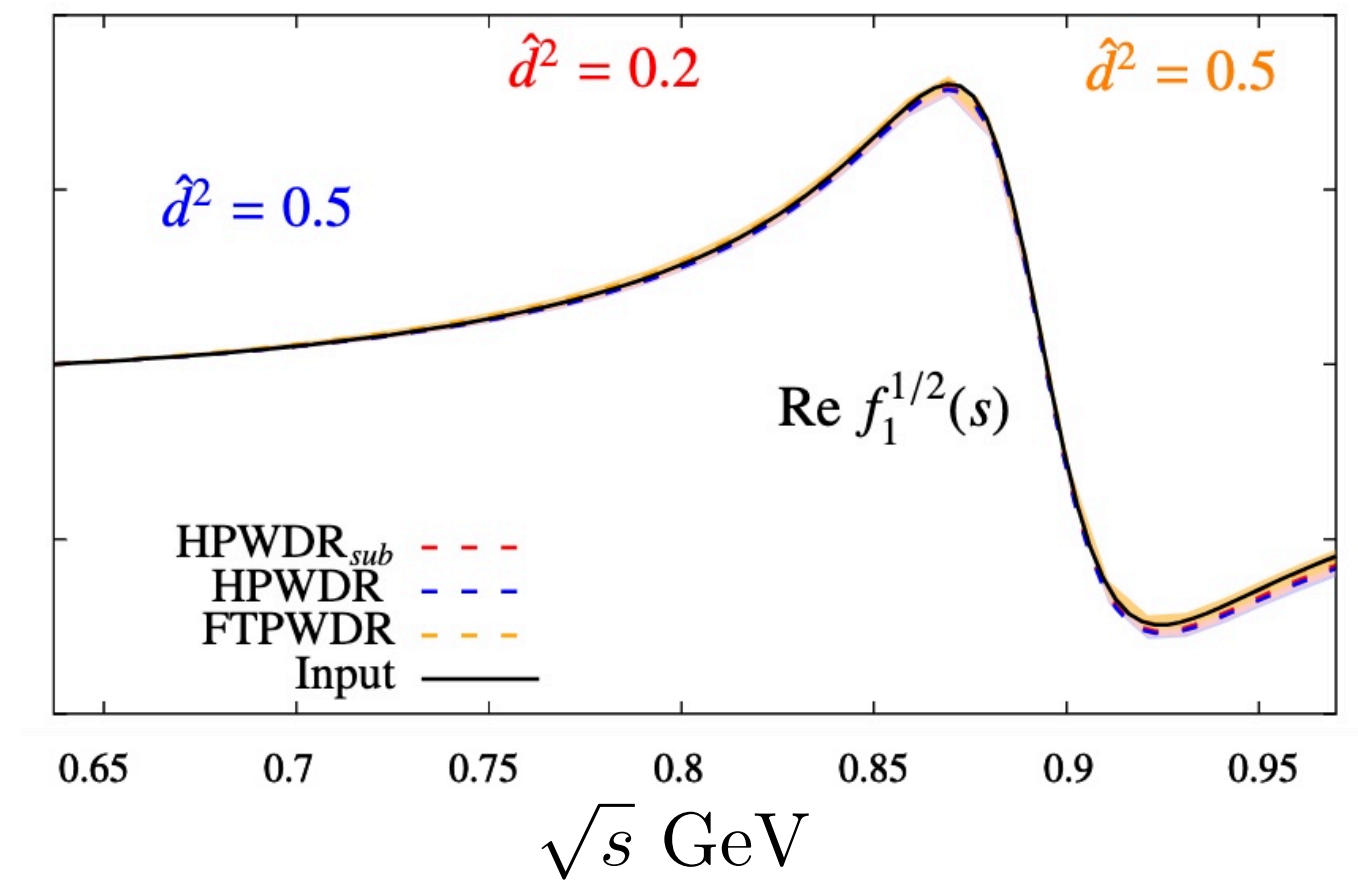
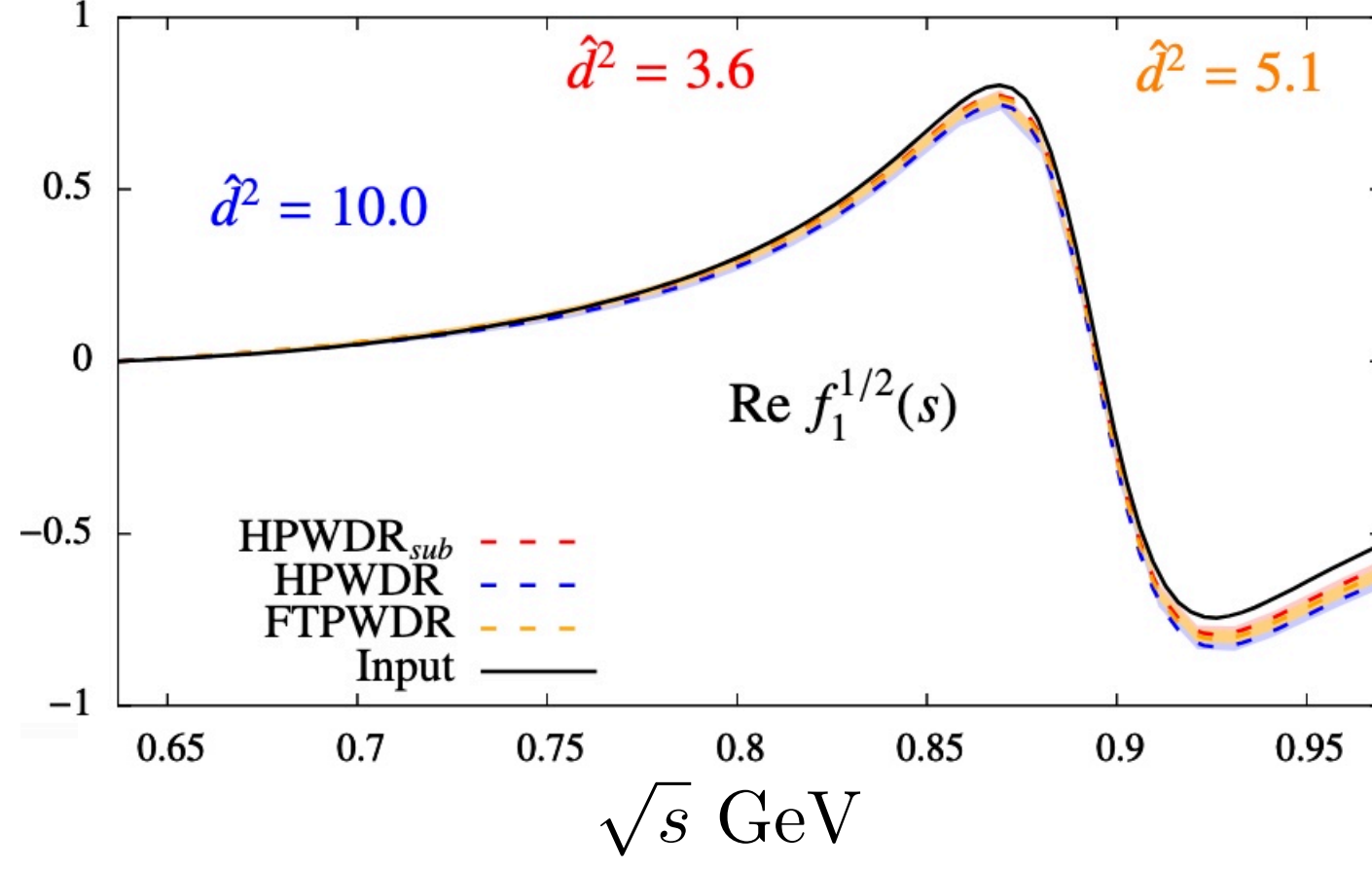
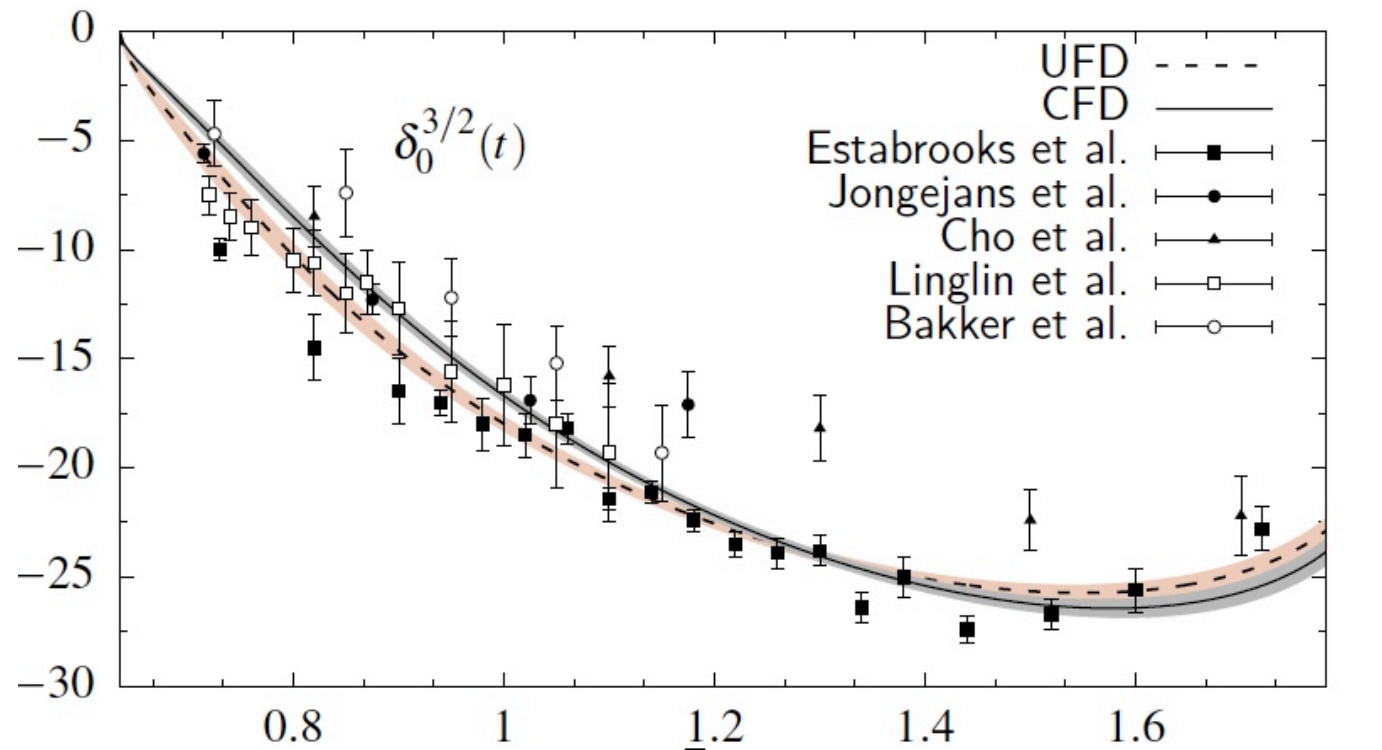
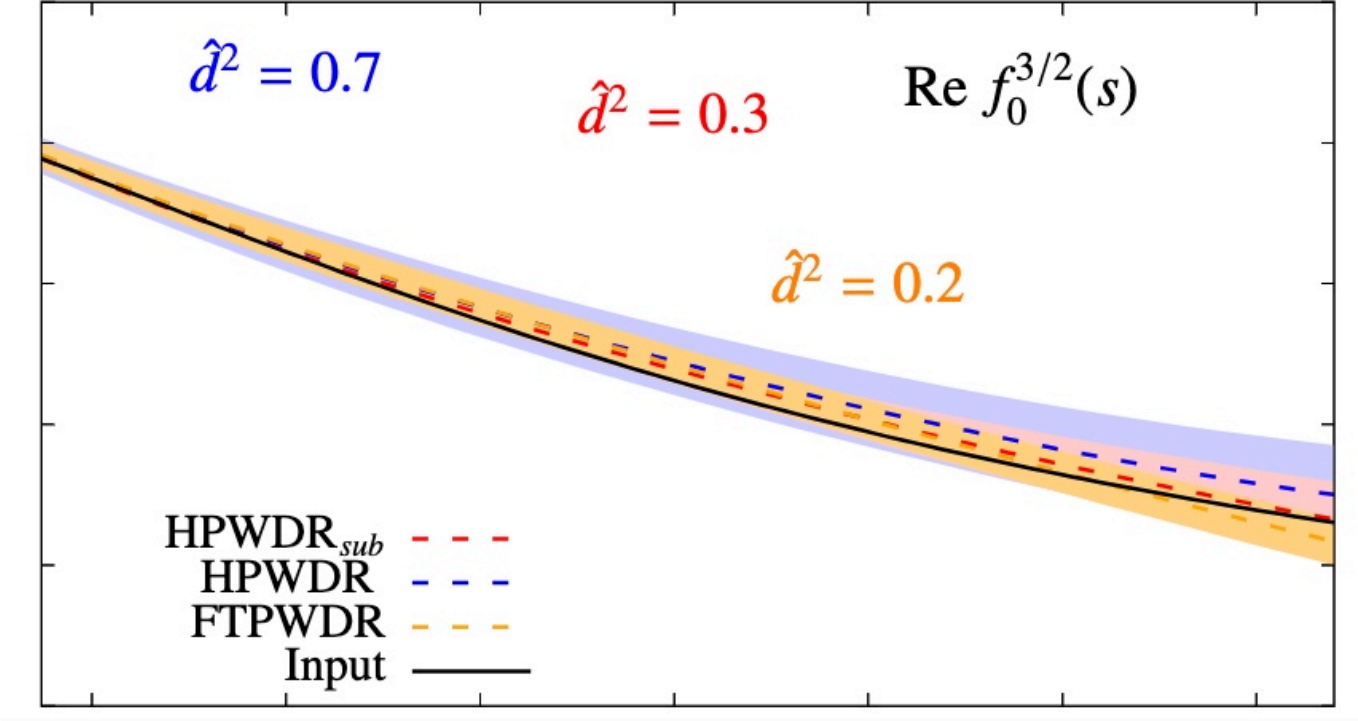
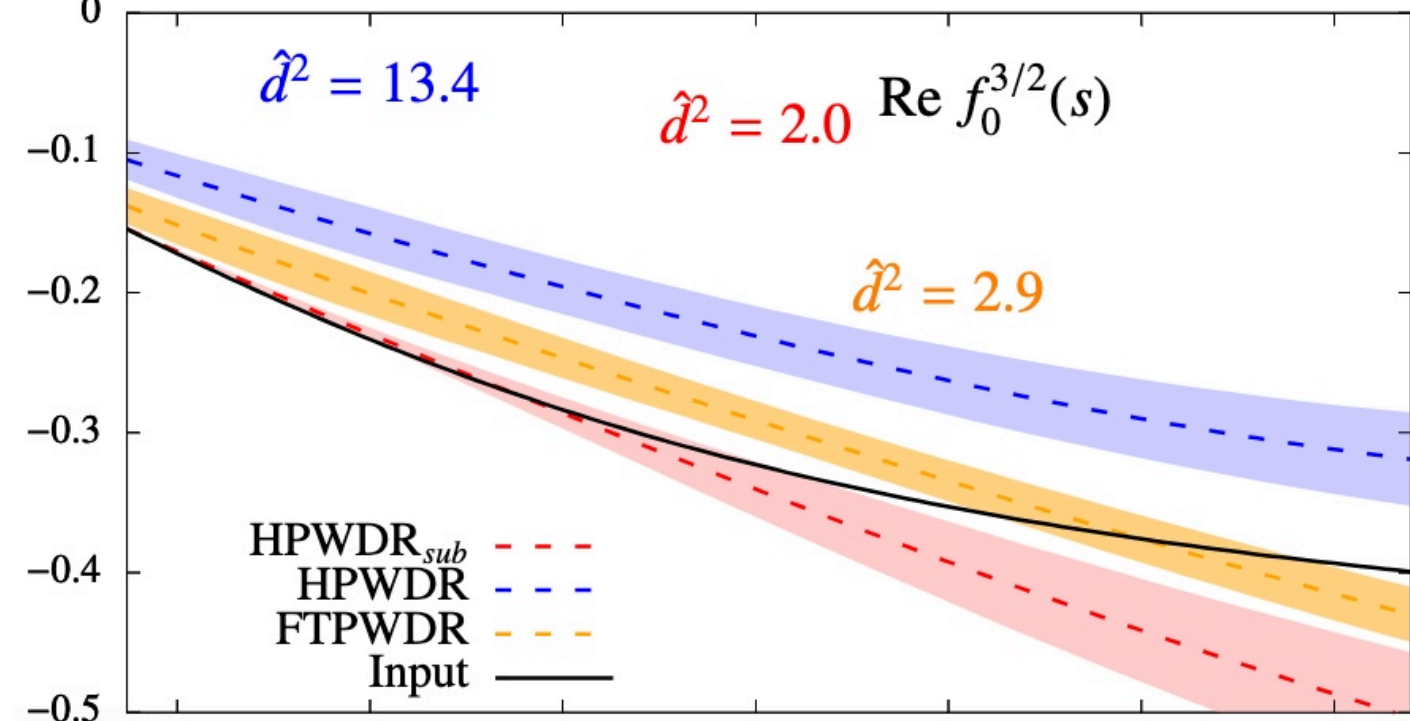
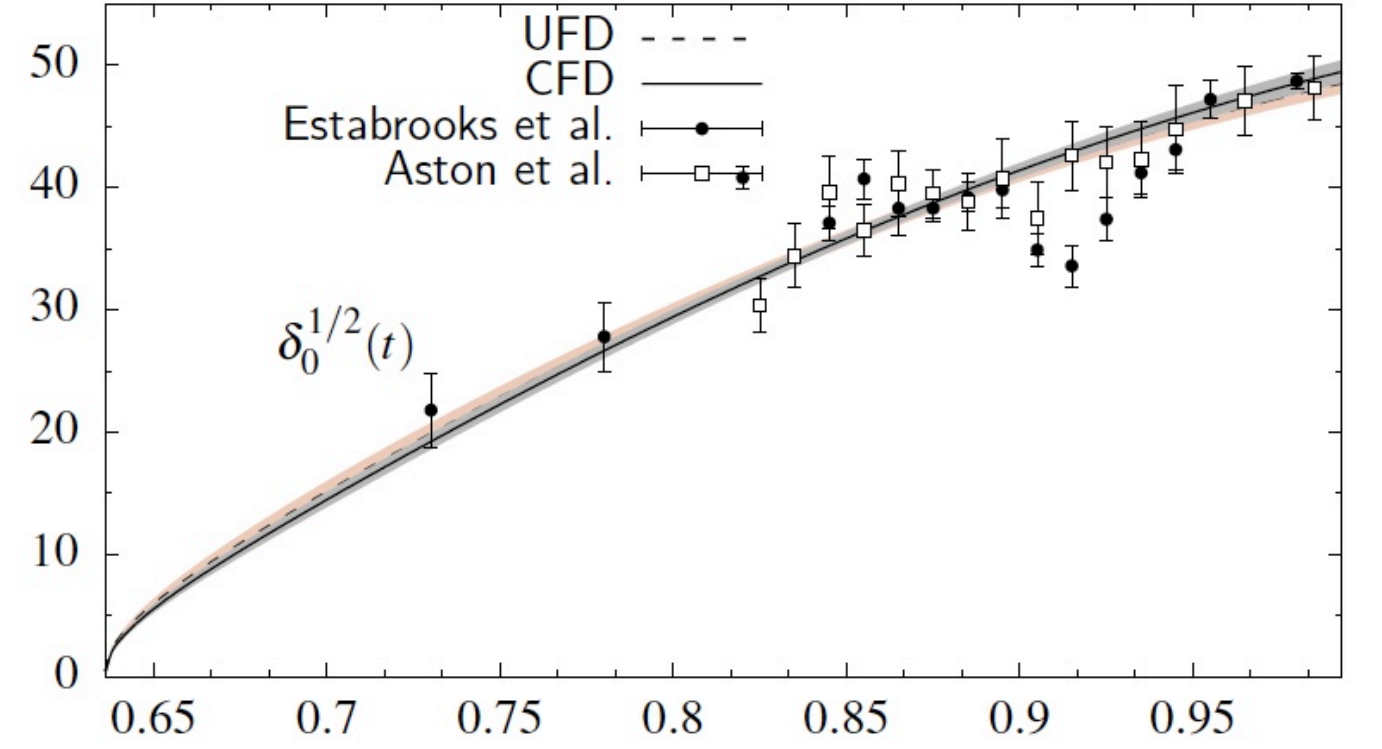
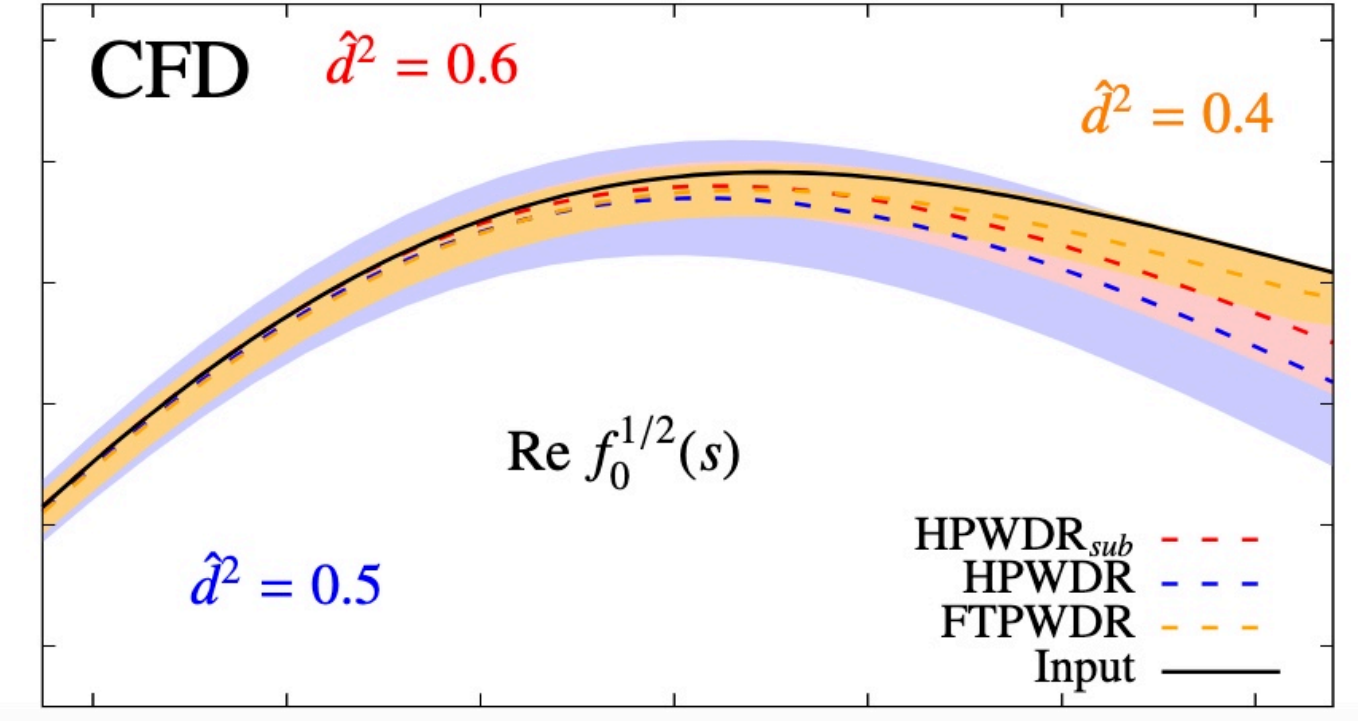
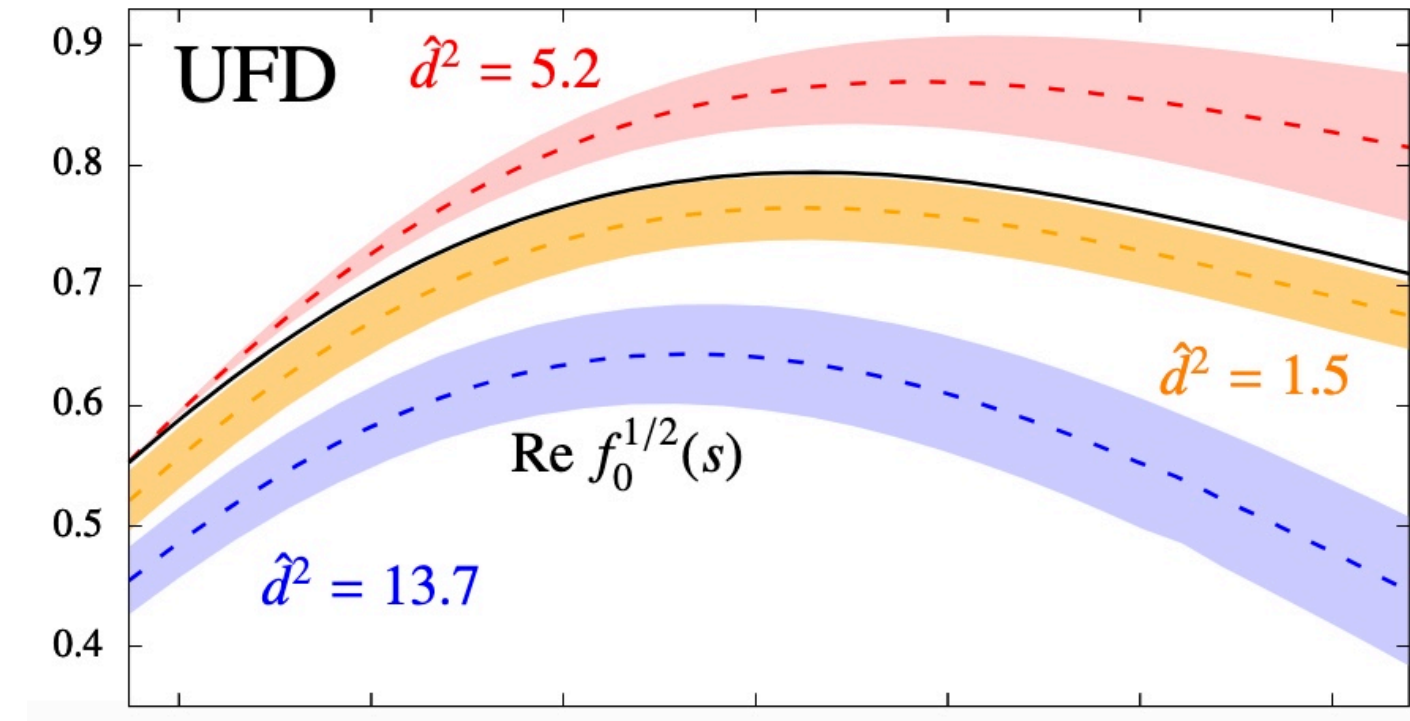

πK scattering

Model-independent results

Dispersive scattering lengths

$$a_0^- = \frac{m_\pi m_K}{2\pi^2 m_+} \int_{m_+^2}^{\infty} \frac{\text{Im } F^-(s')}{(s' - m_-^2)(s' - m_+^2)} ds'$$

Tension between lattice QCD and dispersive results!!

	FINAL	CFD	Paris group
$a_0^{1/2}$	0.224 ± 0.008	0.224 ± 0.011	0.224 ± 0.022
$a_0^{3/2}$	-0.0480 ± 0.0056	-0.048 ± 0.006	-0.0448 ± 0.0077

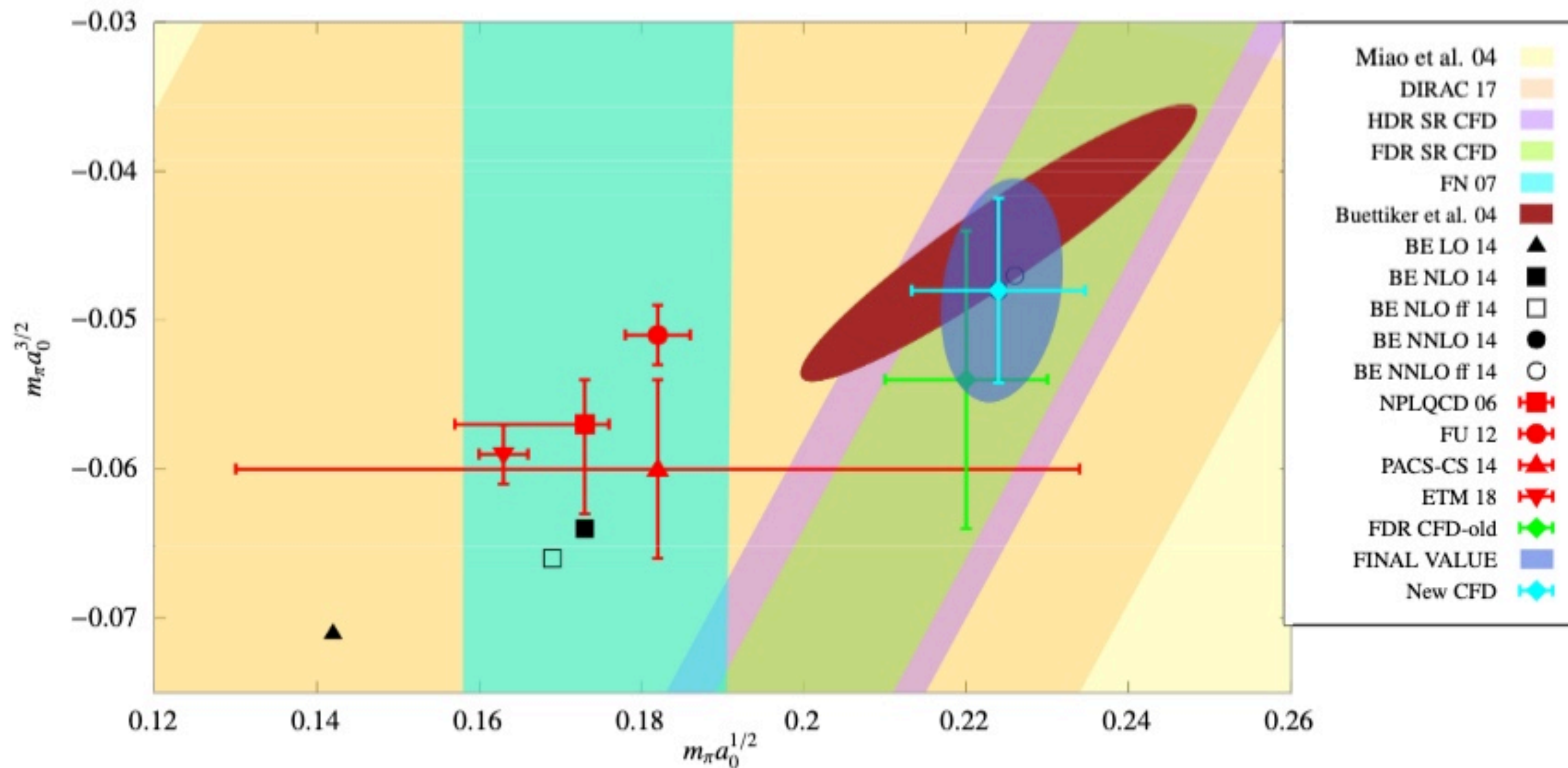

Dispersive analyses

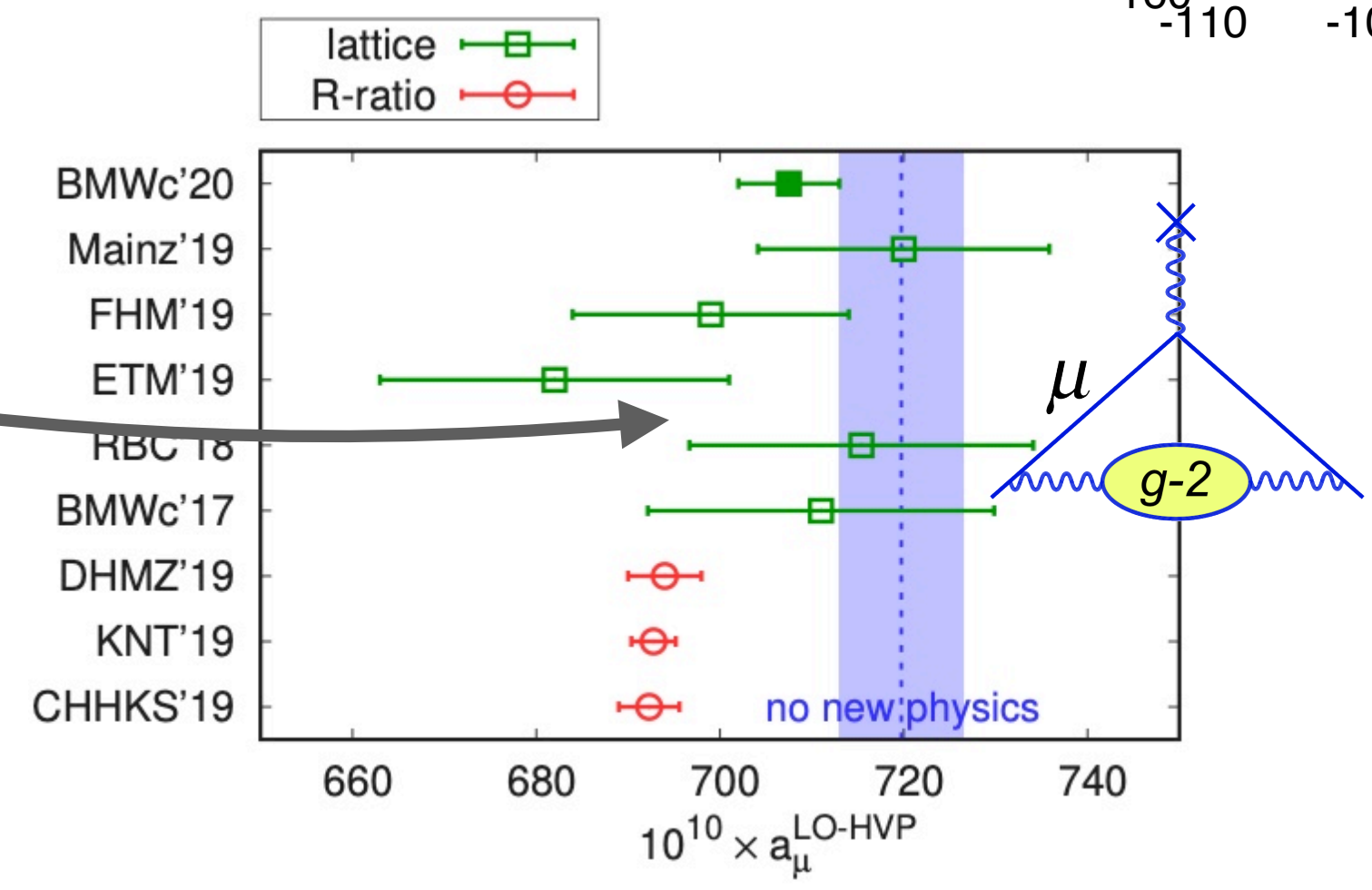
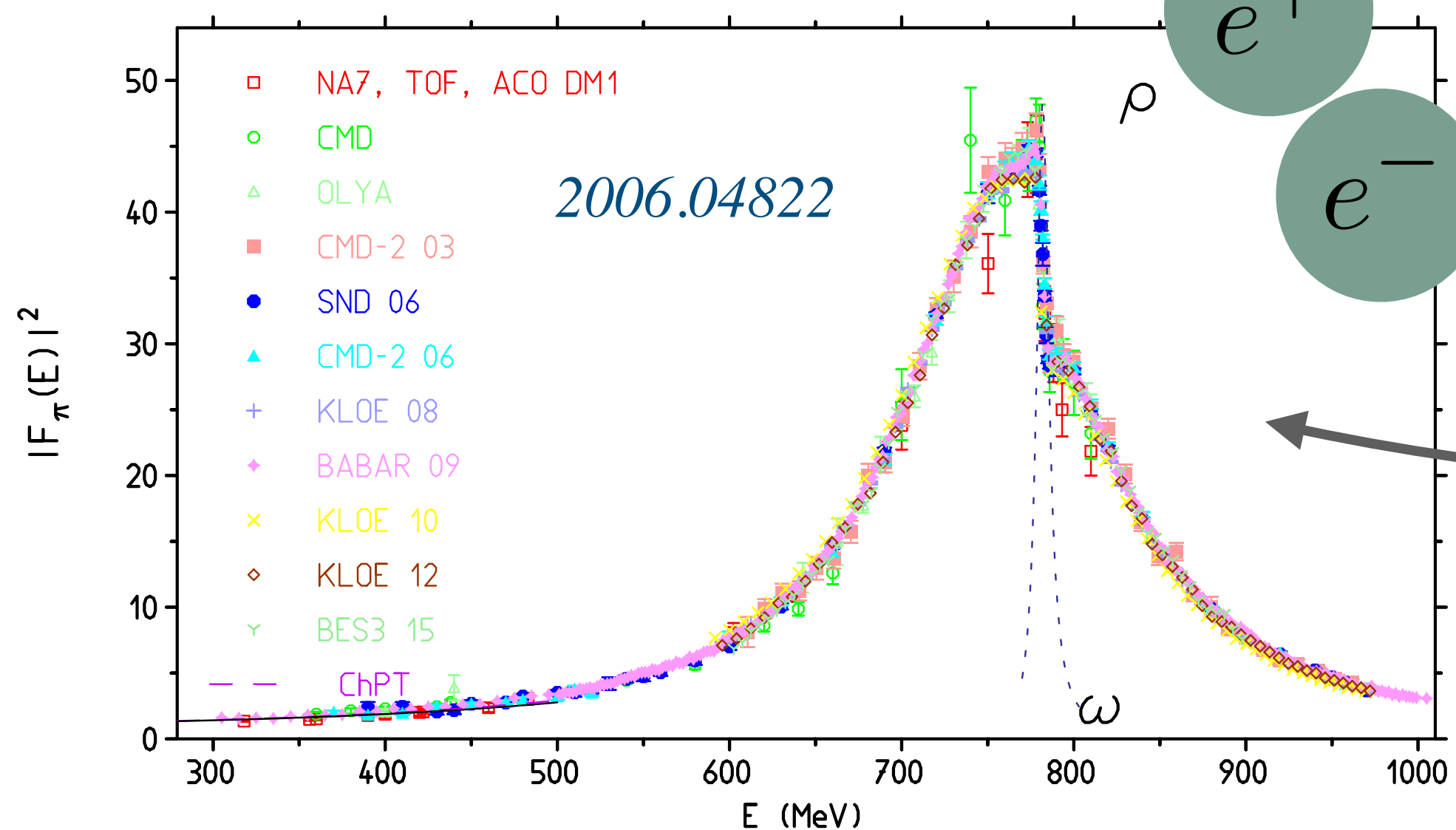
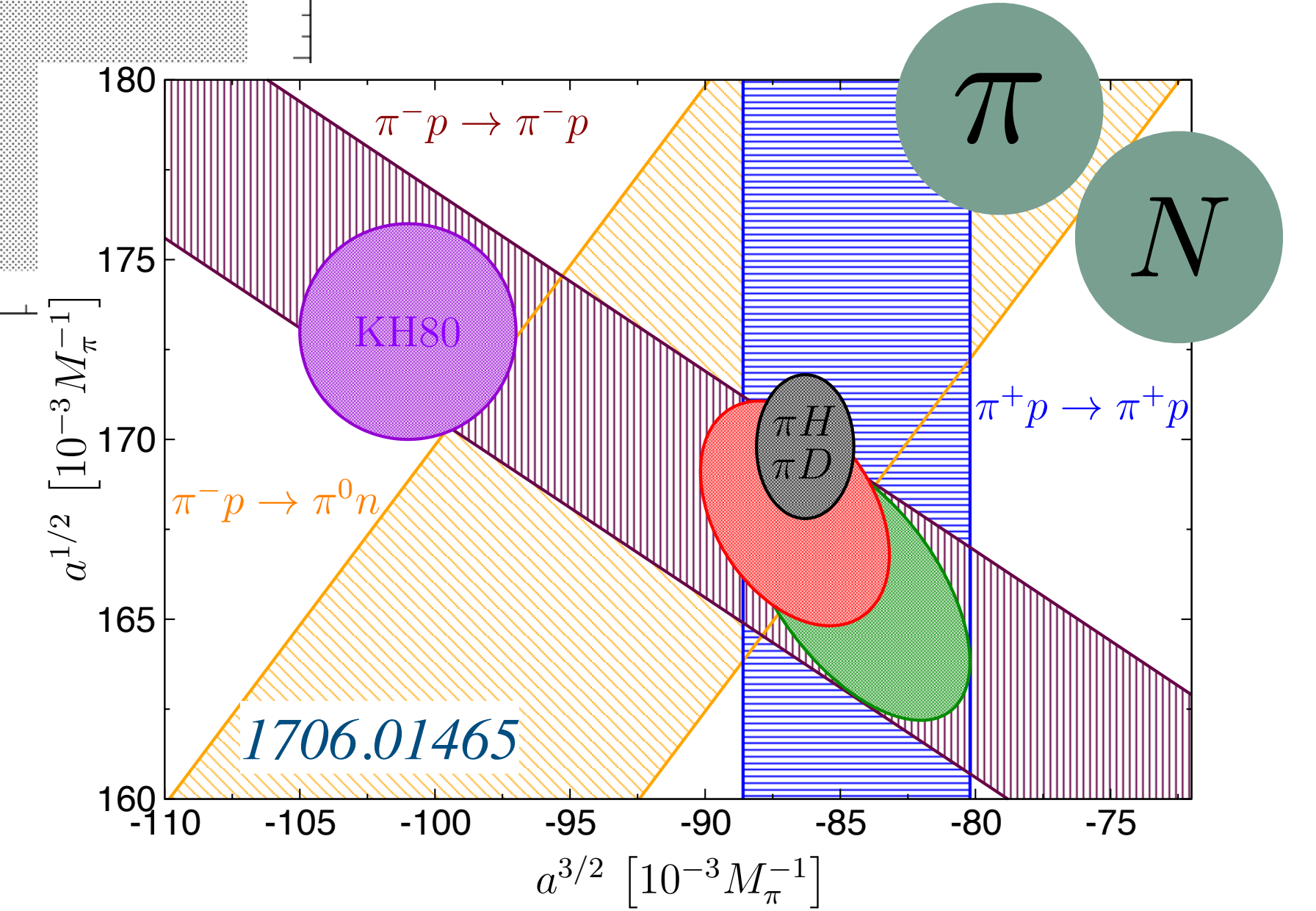
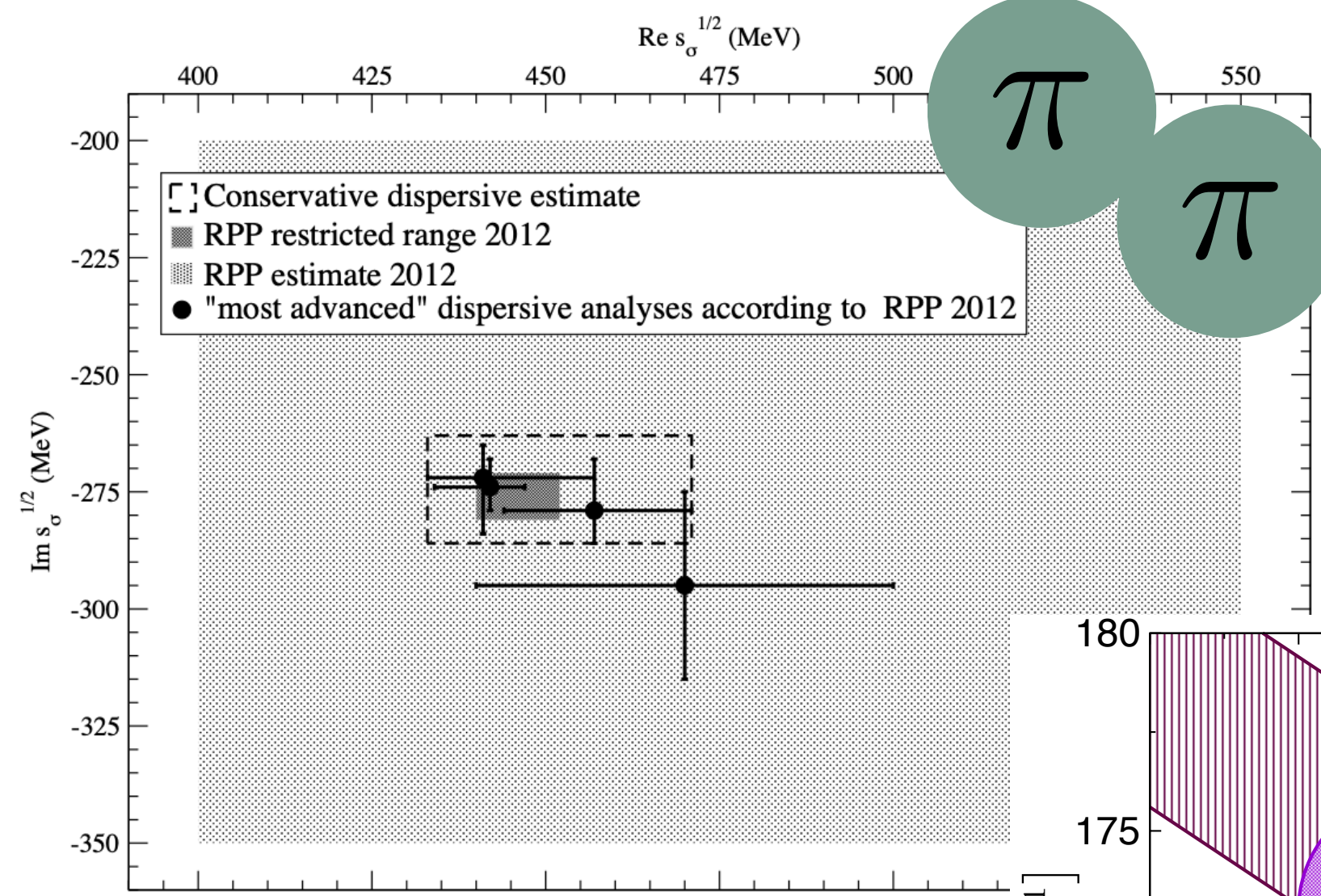
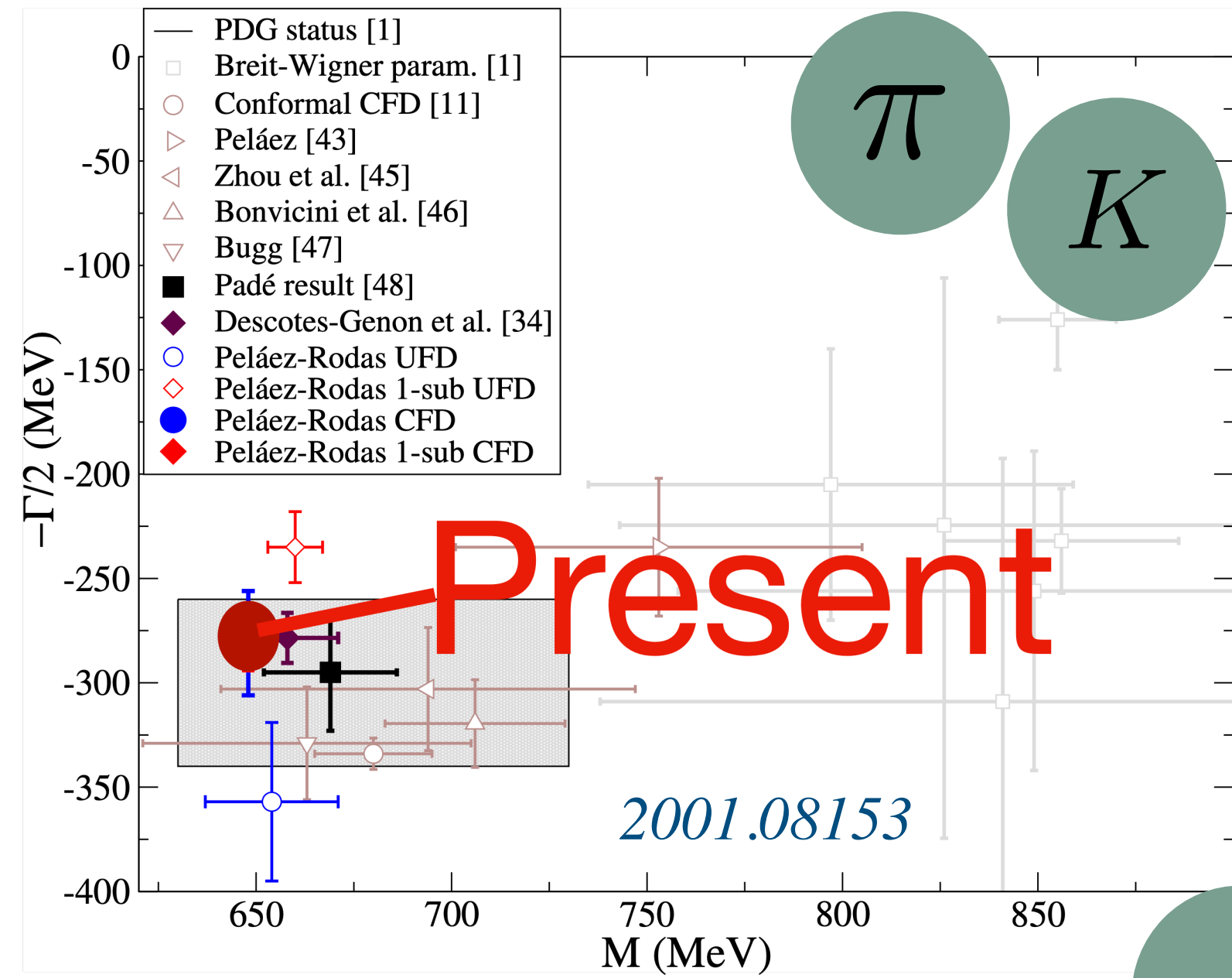

And others...