



K-long Facility at JLab for the Strange Hadron Spectroscopy

Moskov Amaryan

Old Dominion University
Norfolk, VA. USA

York, UK, 21 June, 2024



Outline

-Introduction

-Physics Motivation

- Hyperon Spectroscopy*
- Strange Meson Spectroscopy*
- Early Universe*
- Search for Exotics*

-K_L Facility Beamline and Hardware

- Electron Beam*
- Compact Photon Source*
- Be Target*
- Flux Monitor*
- K_L Beam*
- LH₂/LD₂ Target*

Summary

2

48th PROGRAM ADVISORY COMMITTEE (PAC 48)

August 10-14, 2020

September 25, 2020



Prepared for the U.S. Department of Energy
under Contract DE-AC05-06OR23177

Recommendations

PAC 48 SUMMARY OF RECOMMENDATIONS								
Number	Contact Person	Title	Hall	Days Req'd	Days Awarded	Scientific Rating	PAC Decision	Topic
C12-18-005	M. Boer	Timelike Compton Scattering Off Transversely Polarized Proton	C	50			C2	4
C12-19-001	M. Amarian	Strange Hadron Spectroscopy with Secondary KL Beam in Hall D	D	200	200	A-	Approved	1

Title: Strange Hadron Spectroscopy with Secondary KL Beam in Hall D

Spokespersons: M. Amaryan (contact), M. Bashkanov, S. Dobbs, J. Ritman, J. Stevens, I. Strakovsky

Motivation: The spectroscopy of strange baryons and mesons, including their fundamental strong interactions, are the focus of this proposal. New and unique data can be obtained with an intense K_L beam aimed at a hydrogen/deuterium target, using the GlueX apparatus to detect final state particles.

Measurement and Feasibility: The proponents have answered all questions outlined in the PAC47 report. Substantial progress has been made on the issues of simulations: details on backgrounds and background reactions have been demonstrated, a demonstration of partial wave analysis for hyperon production was given. The proponents have demonstrated the measuring technique of missing mass reconstruction, allowing them to extend the measuring range both regarding small, four-momentum transfers and isospin decomposition. No show stoppers have been pointed out by the TAC.

Issues: The PAC strongly recommends that the collaboration intensify their cooperation on two issues. (1) Coordinated leadership must be established together with the host laboratory to address the various technical issues connected with the R&D efforts and construction of the K_L beam. (2) Continuous cooperation with JPAC and associated members is recommended for the development of tools to master the challenges connected with the clean extraction of $K\pi$ scattering, the identification of the exchange processes at small momentum transfers, and the amplitude analysis for Δ final states.

Summary: The future K_L facility will add a new physics reach to JLab, and the PAC is looking forward to see the idea being materialized, in conjunction with the plans for Hall D as spelled out in the 2019 White Paper. The collaboration should now devote all its energy to turn this challenging project into an experimental facility and in parallel prepare for a successful data analysis.

This happens because of strong support and dedicated efforts of the KLF Collaboration



New Collaborators from Japan

160 physicists from 68 Universities across 19 countries

Strange Hadron Spectroscopy with Secondary K_L Beam in Hall DExperimental Support:

Shankar Adhikari⁴³, Moskov Amaryan (**Contact Person**, **Spokesperson**)⁴³, Arshak Asaturyan¹, Alexander Austregesilo⁴⁹, Marouen Baalouch⁸, Mikhail Bashkanov (**Spokesperson**)⁶³, Vitaly Baturin⁴³, Vladimir Berdnikov^{11,35}, Olga Cortes Becerra¹⁹, Timothy Black⁶⁰, Werner Boeglin¹³, William Briscoe¹⁹, William Brooks⁵⁴, Volker Burkert⁴⁹, Eugene Chudakov⁴⁹, Geraint Clash⁶³, Philip Cole³², Volker Crede¹⁴, Donal Day⁶¹, Pavel Degtyarenko⁴⁹, Alexandre Deur⁴⁹, Sean Dobbs (**Spokesperson**)¹⁴, Gail Dodge⁴³, Anatoly Dolgolenko²⁶, Simon Eidelman^{6,41}, Hovanes Egiyan (**JLab Contact Person**)⁴⁹, Denis Epifanov^{6,41}, Paul Eugenio¹⁴, Stuart Fegan⁶³, Alessandra Filippi²⁵, Sergey Furletov⁴⁹, Liping Gan⁶⁰, Franco Garibaldi²⁴, Ashot Gasparian³⁹, Gagik Gavalian⁴⁹, Derek Glazier¹⁸, Colin Gleason²², Vladimir Goryachev²⁶, Lei Guo¹⁴, David Hamilton¹¹, Avetik Hayrapetyan¹⁷, Garth Huber⁵³, Andrew Hurley⁵⁶, Charles Hyde⁴³, Isabella Illari¹⁹, David Ireland¹⁸, Igal Jaegle⁴⁹, Kyungseon Joo⁵⁷, Vanik Kakoyan¹, Grzegorz Kalicy¹¹, Mahmoud Kamel¹³, Christopher Keith⁴⁹, Chan Wook Kim¹⁹, Eberhard Klemp⁵, Geoffrey Krafft⁴⁹, Sebastian Kuhn⁴³, Sergey Kuleshov², Alexander Laptev³³, Ilya Larin^{26,59}, David Lawrence⁴⁹, Daniel Lersch¹⁴, Wenliang Li⁵⁶, Kevin Luckas²⁸, Valery Lyubovitskiy^{50,51,52,54}, David Mack⁴⁹, Michael McCaughan⁴⁹, Mark Manley³⁰, Hrachya Marukyan¹, Vladimir Matveev²⁶, Mihai Mocanu⁶³, Viktor Mokeev⁴⁹, Curtis Meyer⁹, Bryan McKinnon¹⁸, Frank Nerling^{15,16}, Matthew Nicol⁶³, Gabriel Niculescu²⁷, Alexander Ostrovidov¹⁴, Zisis Papandreou⁵³, KiJun Park⁴⁹, Eugene Pasyuk⁴⁹, Peter Pauli¹⁸, Lubomir Pentchev⁴⁹, William Phelps¹⁰, John Price⁷, Jörg Reinhold¹³, James Ritman (**Spokesperson**)^{28,68}, Dimitri Romanov²⁶, Carlos Salgado⁴⁰, Todd Satogata⁴⁹, Susan Schadmand²⁸, Amy Schertz⁵⁶, Axel Schmidt¹⁹, Daniel Sober¹¹, Alexander Somov⁴⁹, Sergei Somov³⁵, Justin Stevens (**Spokesperson**)⁵⁶, Igor Strakovsky (**Spokesperson**)¹⁹, Victor Tarasov²⁶, Simon Taylor⁴⁹, Annika Thiel⁵, Guido Maria Urciuoli²⁴, Holly Szumila-Vance¹⁹, Daniel Watts⁶³, Lawrence Weinstein⁴³, Timothy Whitlatch⁴⁹, Nilanga Wickramaarachchi⁴³, Bogdan Wojtsekhowski⁴⁹, Nicholas Zachariou⁶³, Jonathan Zarling⁵³, Jixie Zhang⁶¹

Theoretical Support:

Alexey Anisovich^{5,44}, Alexei Bazavov³⁸, Rene Bellwied²¹, Veronique Bernard⁴², Gilberto Colangelo³, Aleš Ciepły⁴⁶, Michael Döring¹⁹, Ali Eskanderian¹⁹, Jose Goity^{20,49}, Helmut Haberzettl¹⁹, Mirza Hadžimehmedović⁵⁵, Robert Jaffe³⁶, Boris Kopeliovich⁵⁴, Heinrich Leutwyler³, Maxim Mai¹⁹, Terry Mart⁶⁵, Maxim Matveev⁴⁴, Ulf-G. Meißner^{5,29}, Colin Morningstar⁹, Bachir Moussallam⁴², Kanzo Nakayama⁵⁸, Wolfgang Ochs³⁷, Youngseok Oh³¹, Rifat Omerovic⁵⁵, Hedim Osmanović⁵⁵, Eulogio Oset⁶², Antimo Palano⁶⁴, Jose Peláez³⁴, Alessandro Pilloni^{66,67}, Maxim Polyakov⁴⁸, David Richards⁴⁹, Arkaitz Rodas^{49,56}, Dan-Olof Riska¹², Jacobo Ruiz de Elvira³, Hui-Young Ryu⁴⁵, Elena Santopinto²³, Andrey Sarantsev^{5,44}, Jugoslav Stahov⁵⁵, Alfred Švarc⁴⁷, Adam Szczepaniak^{22,49}, Ronald Workman¹⁹, Bing-Song Zou⁴

arXiv:2008.08215v3 [nucl-ex] 4 Mar 2021

JLAB

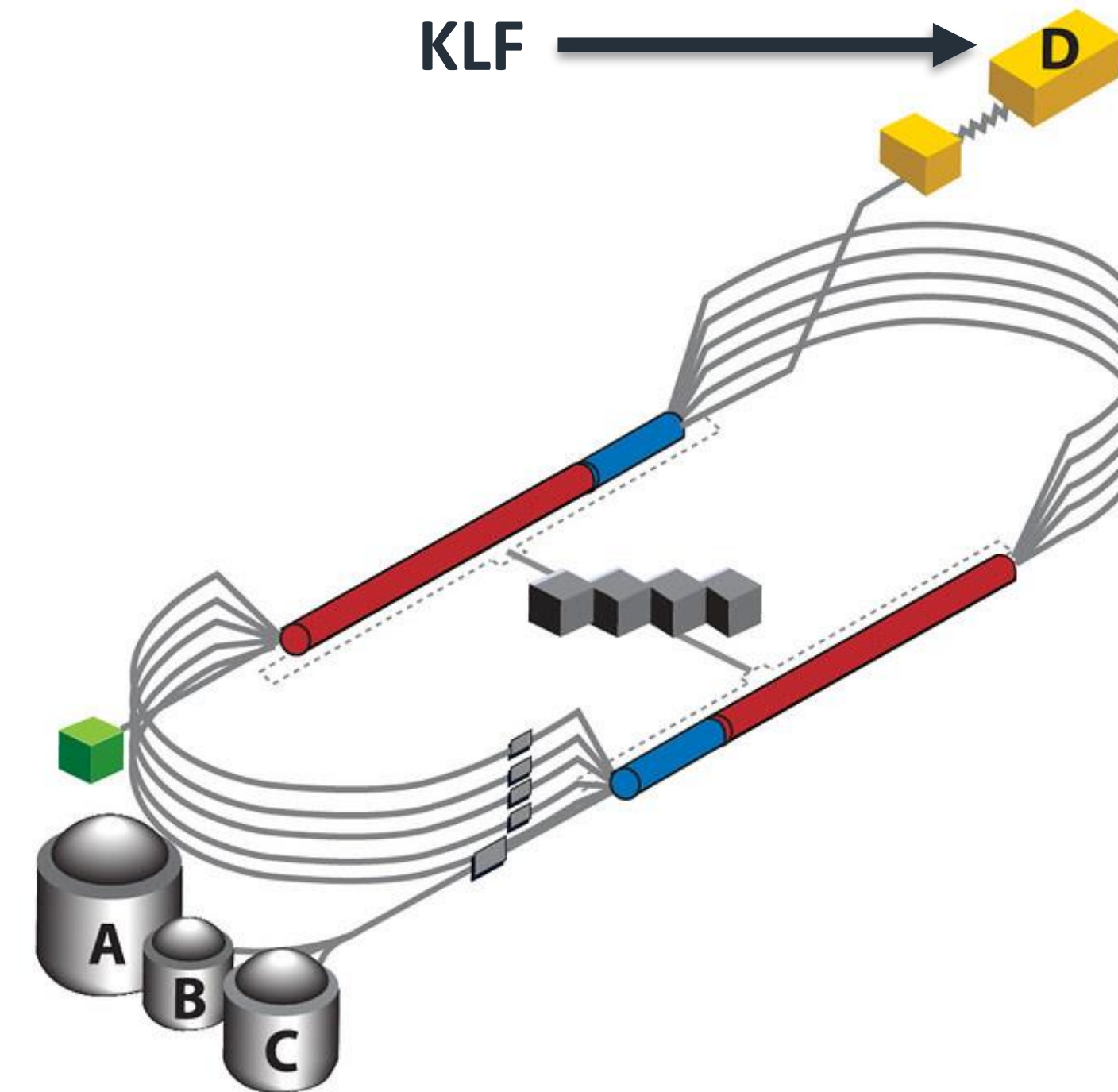

Electron Beam:

- 12 GeV
- $5\mu A$
- 128ns bunch spacing

Hall-D beamline and GlueX Setup

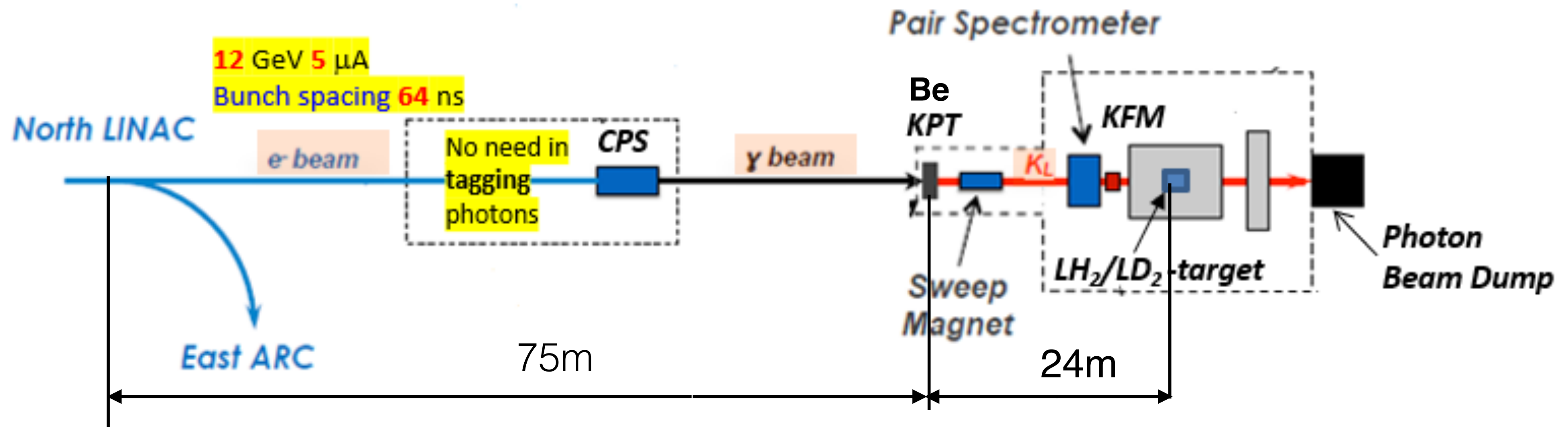

<https://arxiv.org/pdf/2008.08215.pdf>

K_L Beam Flux

JLab 12 GeV

SLAC 16 GeV

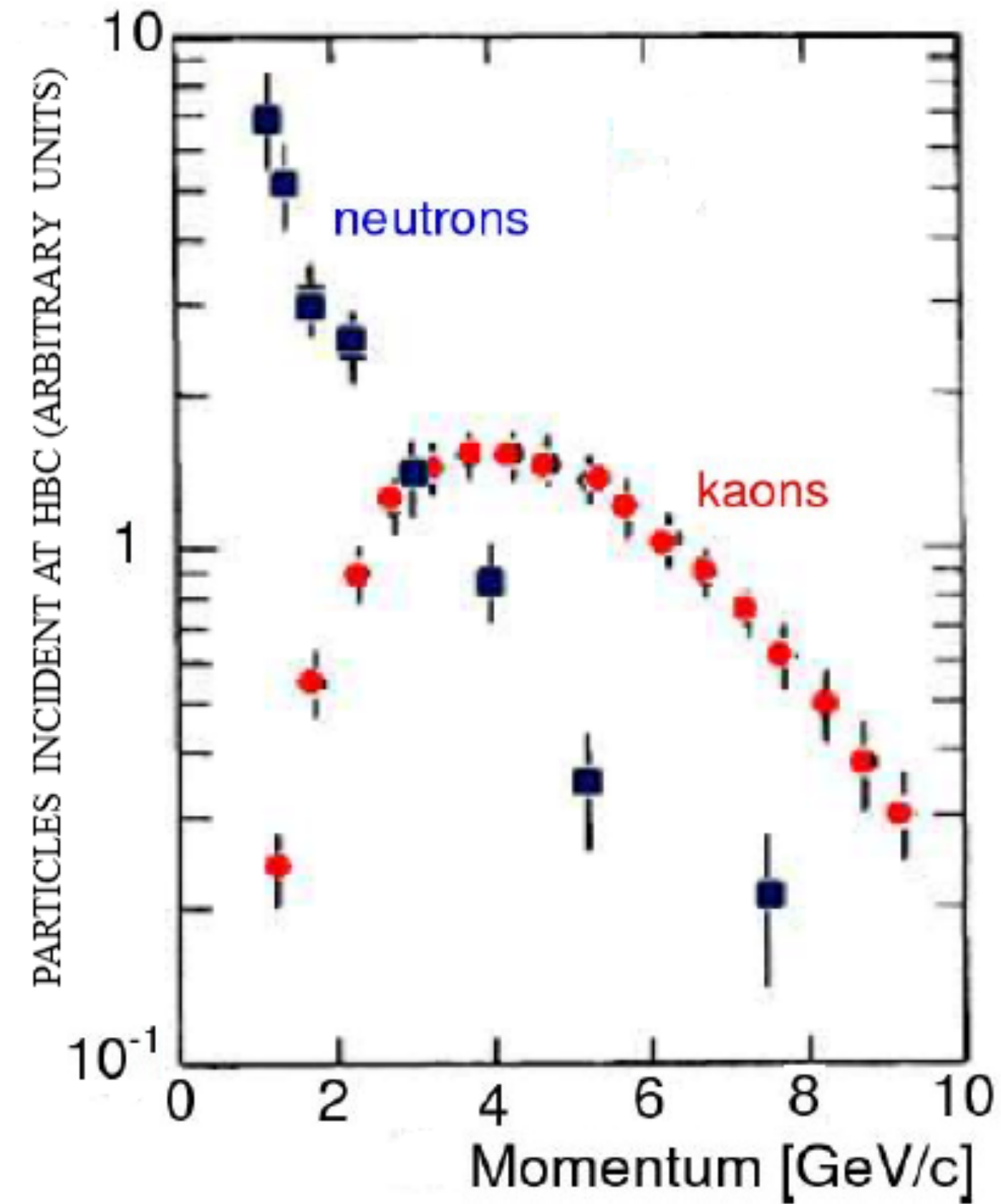
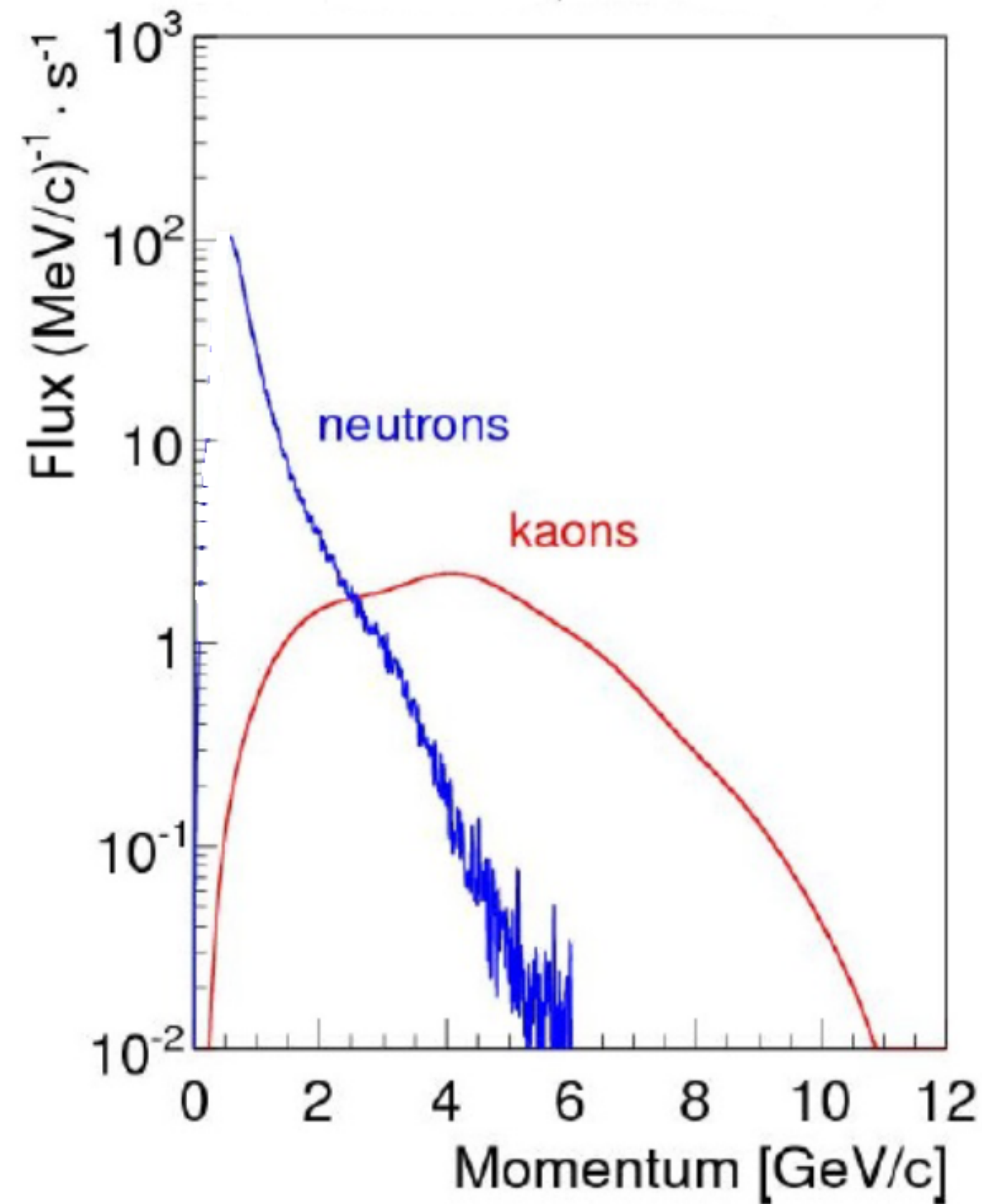

$$N(K_L)/sec \sim 10^4$$

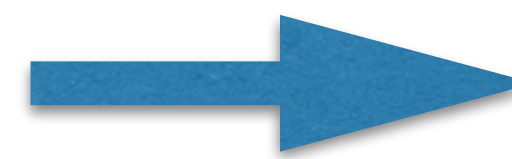

$$\frac{N(K_L)_{JLAB}}{N(K_L)_{SLAC}} \sim 10^3$$

Hyperon Spectroscopy

LQCD in addition to already known states

predicts many more including hybrids (thick bordered)

8-states

5-states

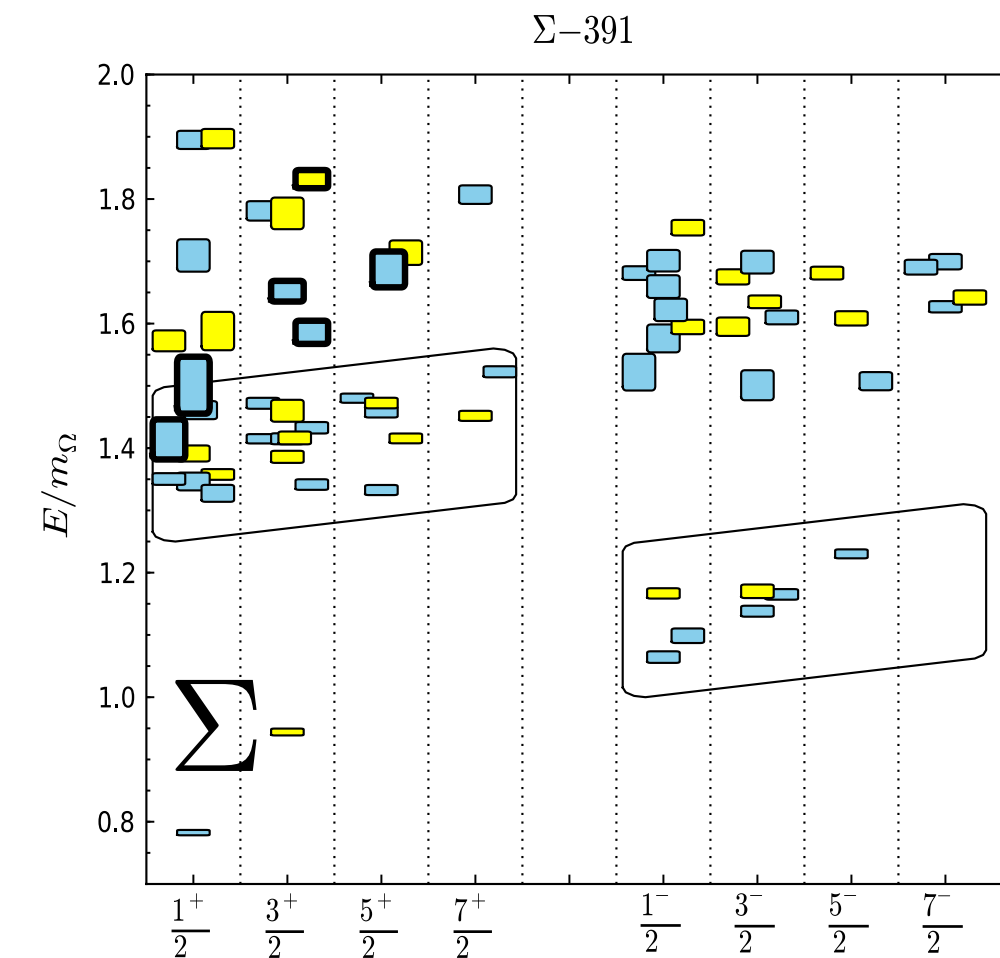
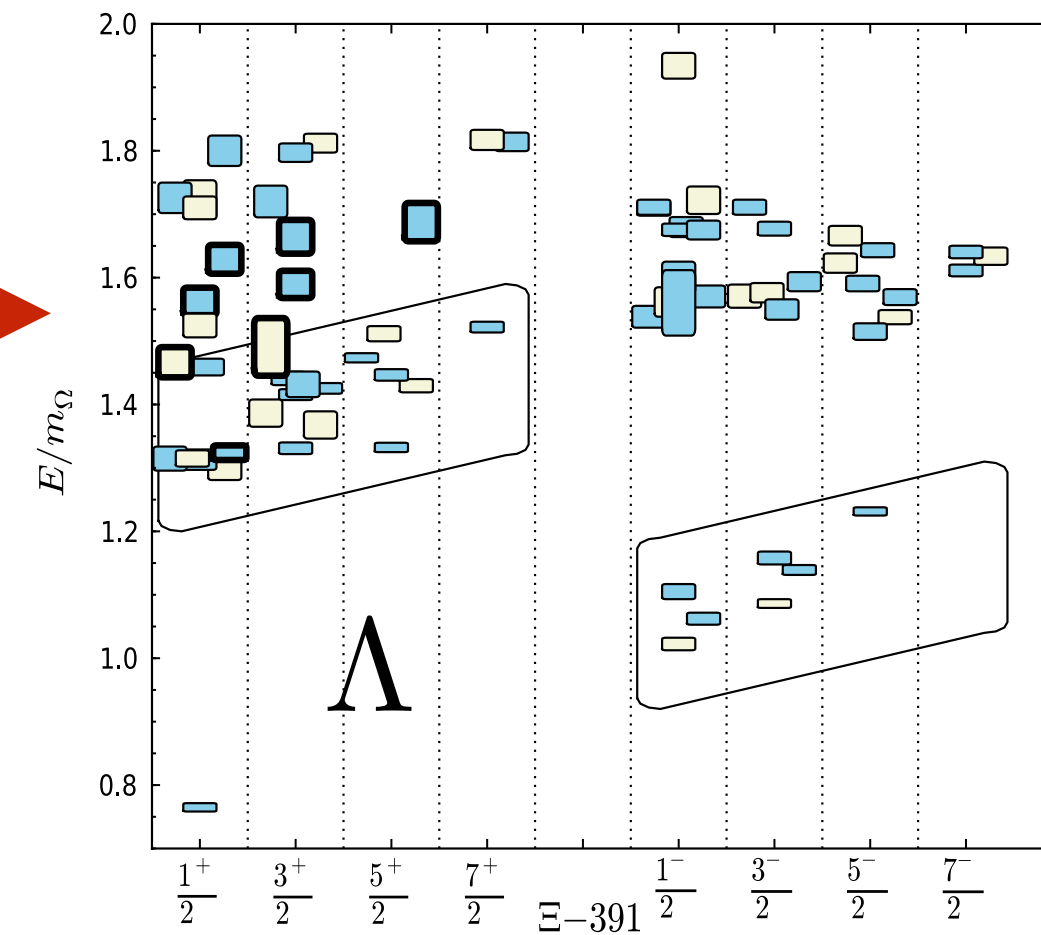

6-states

4-states

3-states

4-states

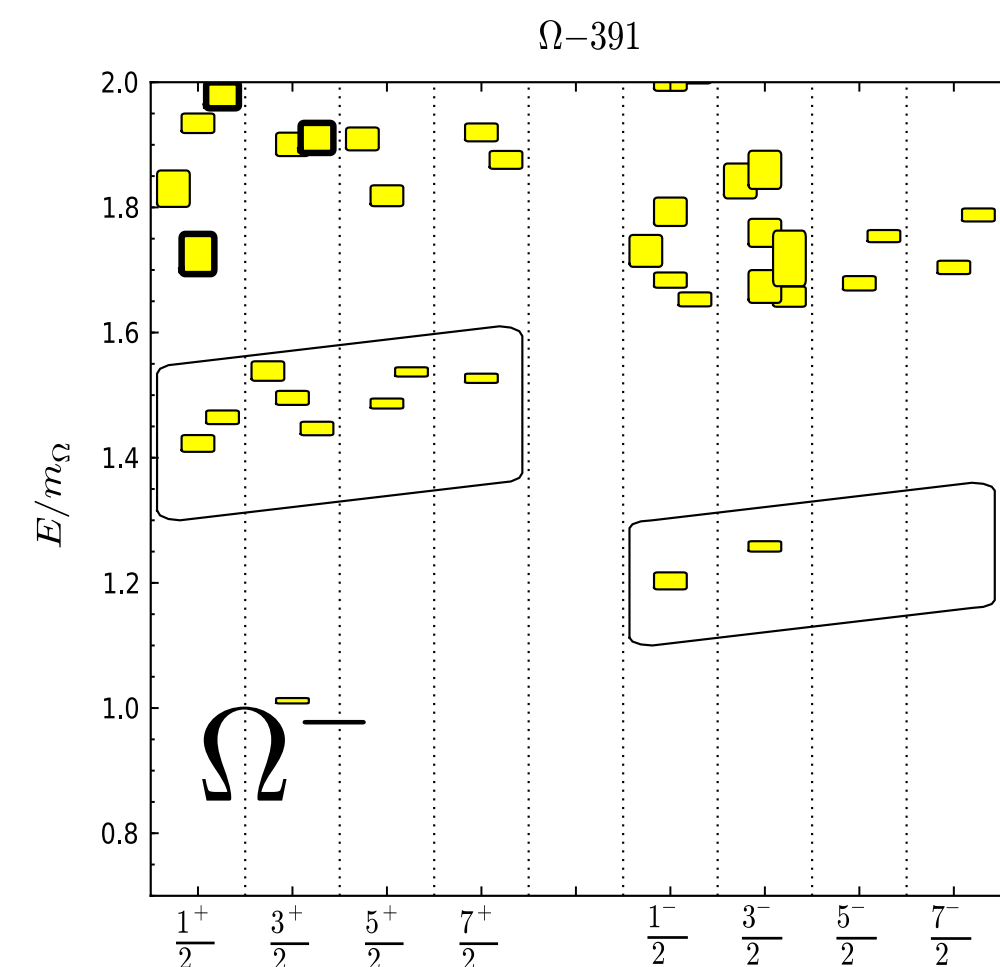
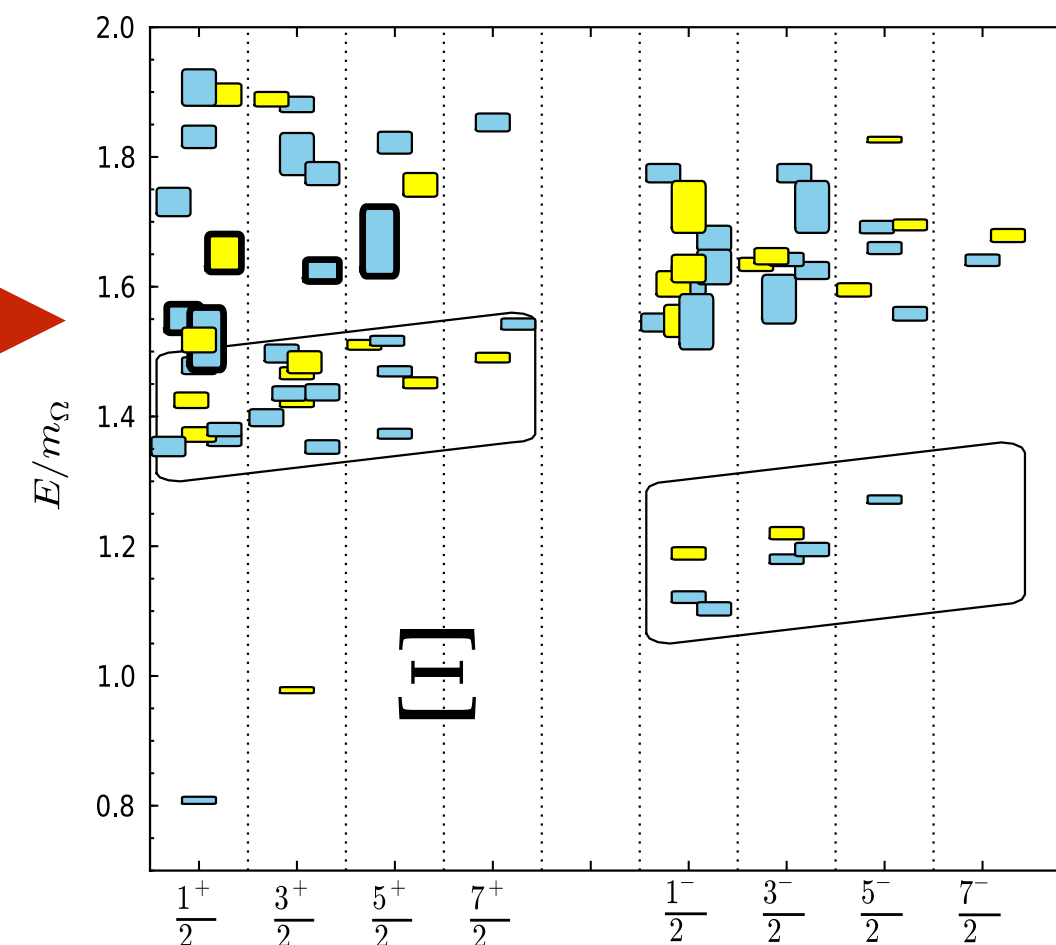

1-state

1-state

Edwards, Mathur, Richards and Wallace, *Phys. Rev. D* 87, 054506 (2013)

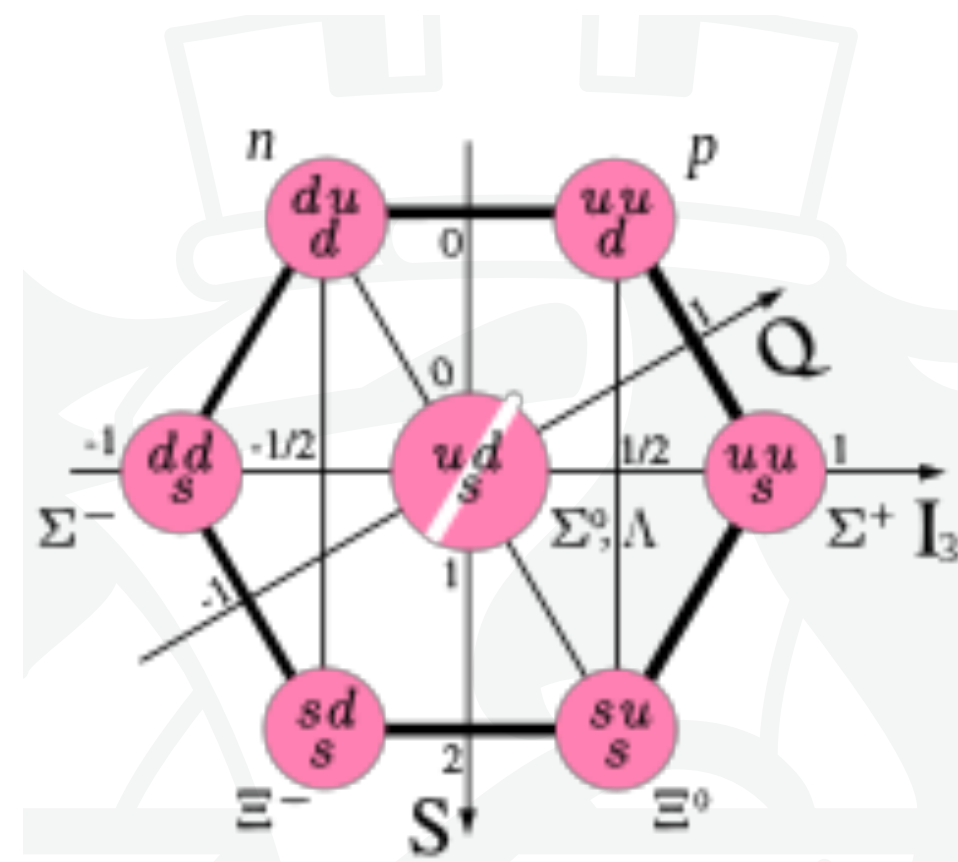

Octet: N^* , Λ^* , Σ^* , Ξ^*
 Decuplet: Δ^* , Σ^* , Ξ^* , Ω^*

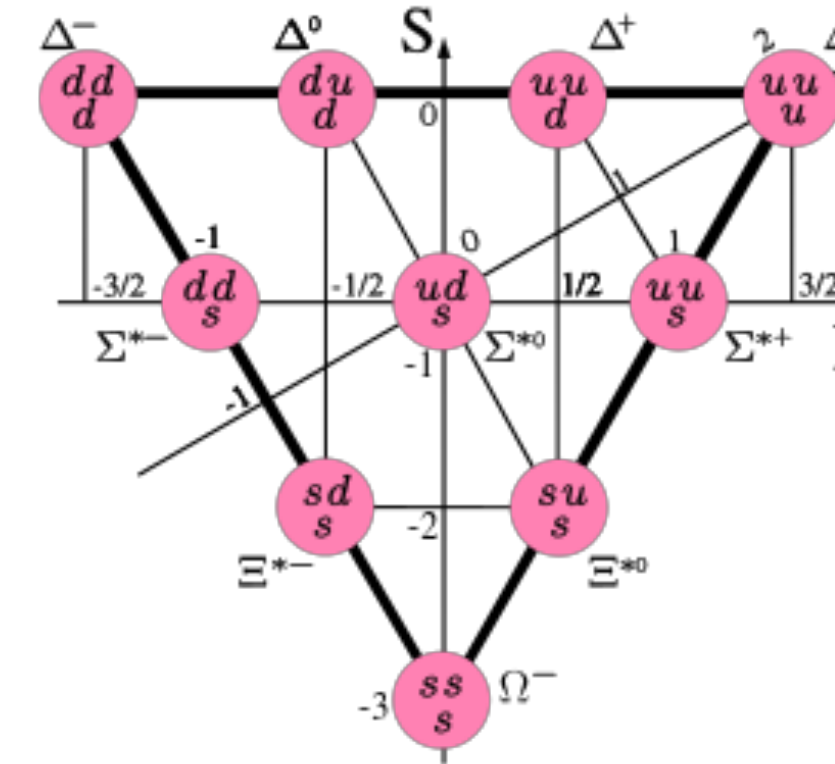

	Predicted LQCD, $M_B < 2.5 \text{ GeV}$	"Observed", PDG
N^*	64	21
Δ^*	22	12
Λ^*	17	14
Σ^*	43	9
Ξ^*	42	6
Ω^*	24	2

212

64

Electron Beam Parameters

$$E_e = 12 \text{ GeV} \quad I = 5 \mu\text{A}$$

$$\text{Bunch spacing} \quad 64 \text{ ns}$$

128 ns confirmed feasible

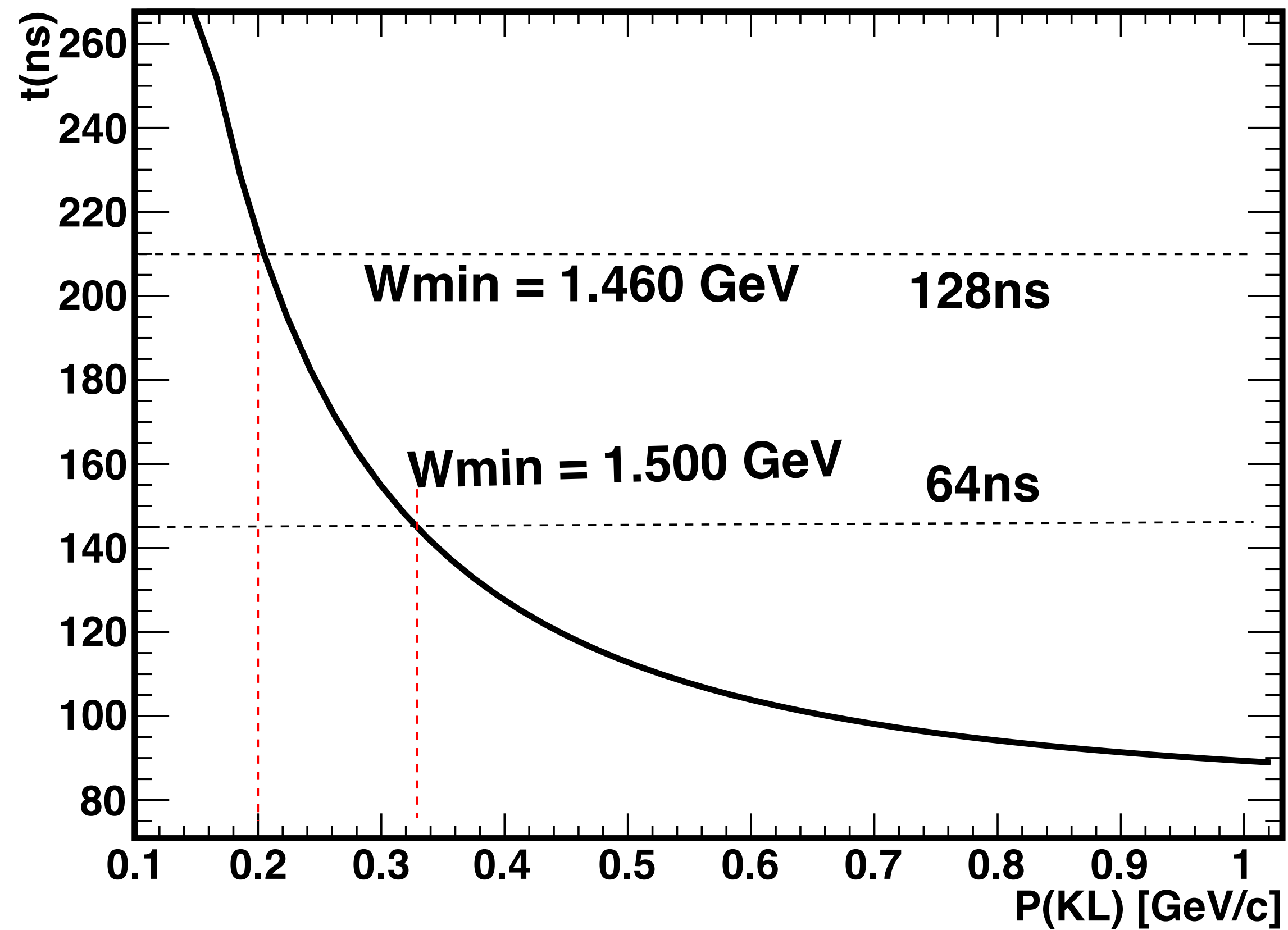

5.7 K_L Momentum Determination and Beam Resolution

The mean lifetime of the K_L is 51.16 nsec ($c\tau = 15.3$ m) whereas the mean lifetime of the K^- is 12.38 nsec ($c\tau = 3.7$ m) [1]. For this reason, it is much easier to perform measurements of $K_L p$ scattering at low beam energies compared with $K^- p$ scattering.

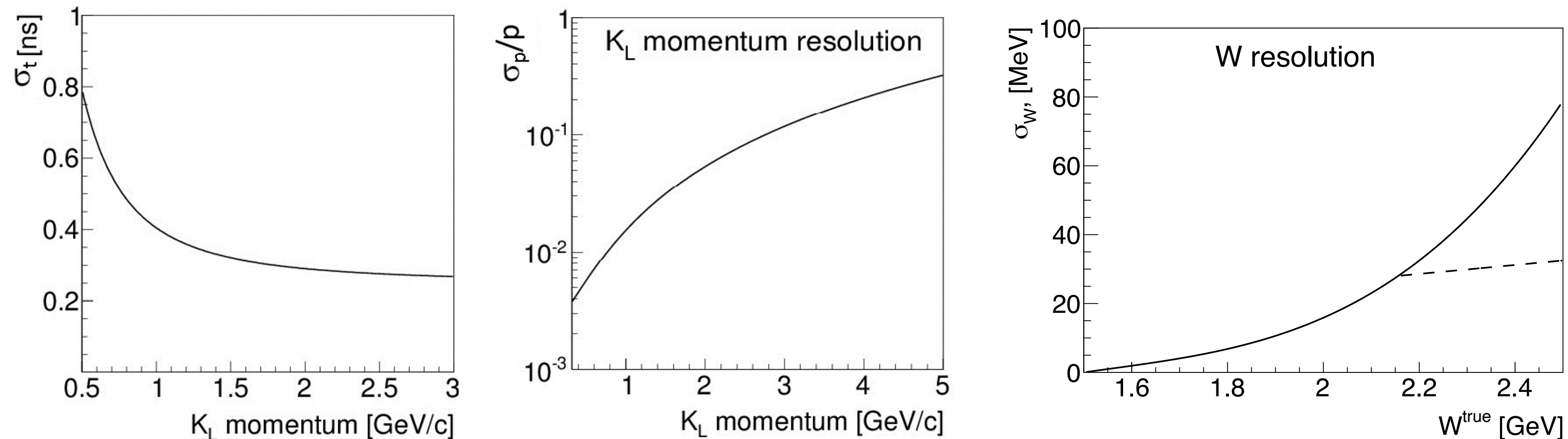
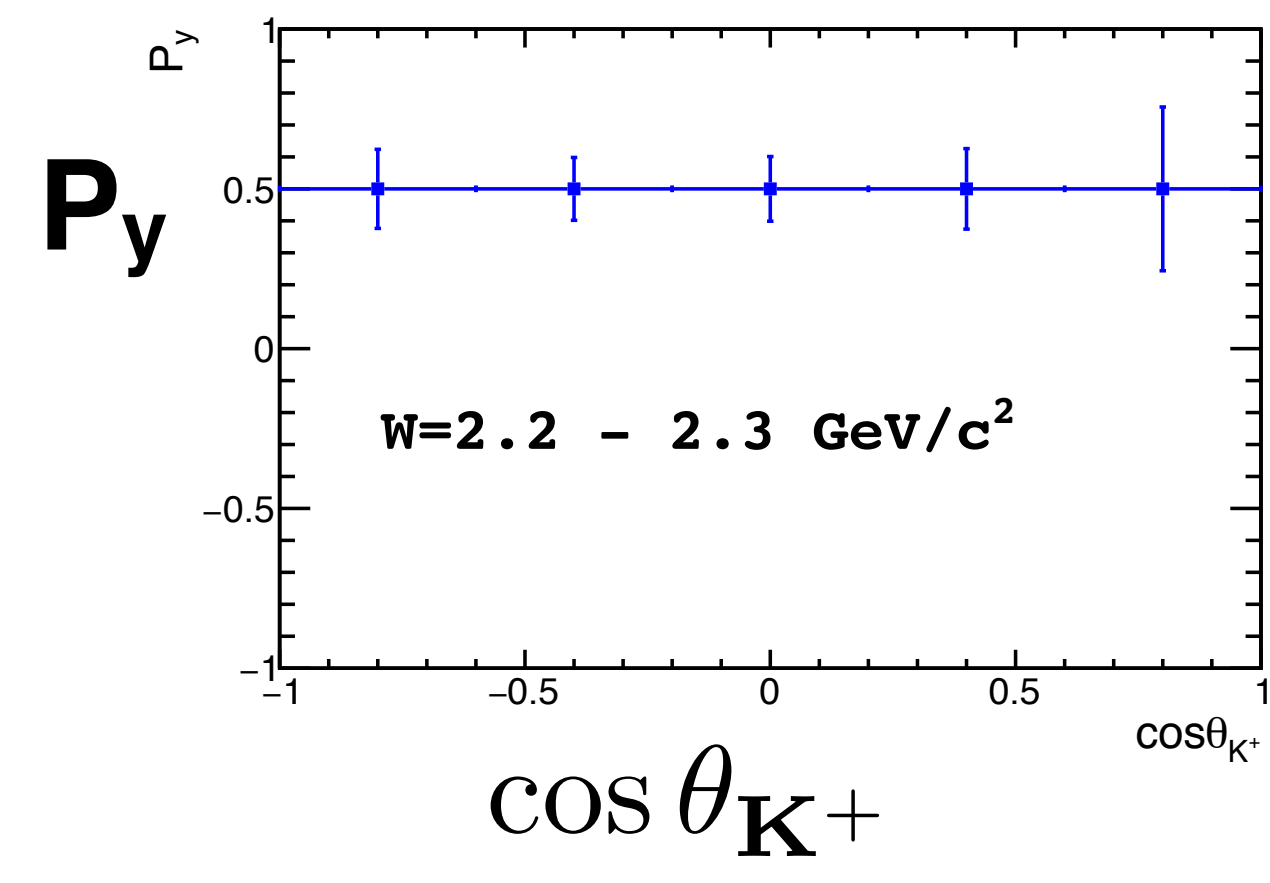
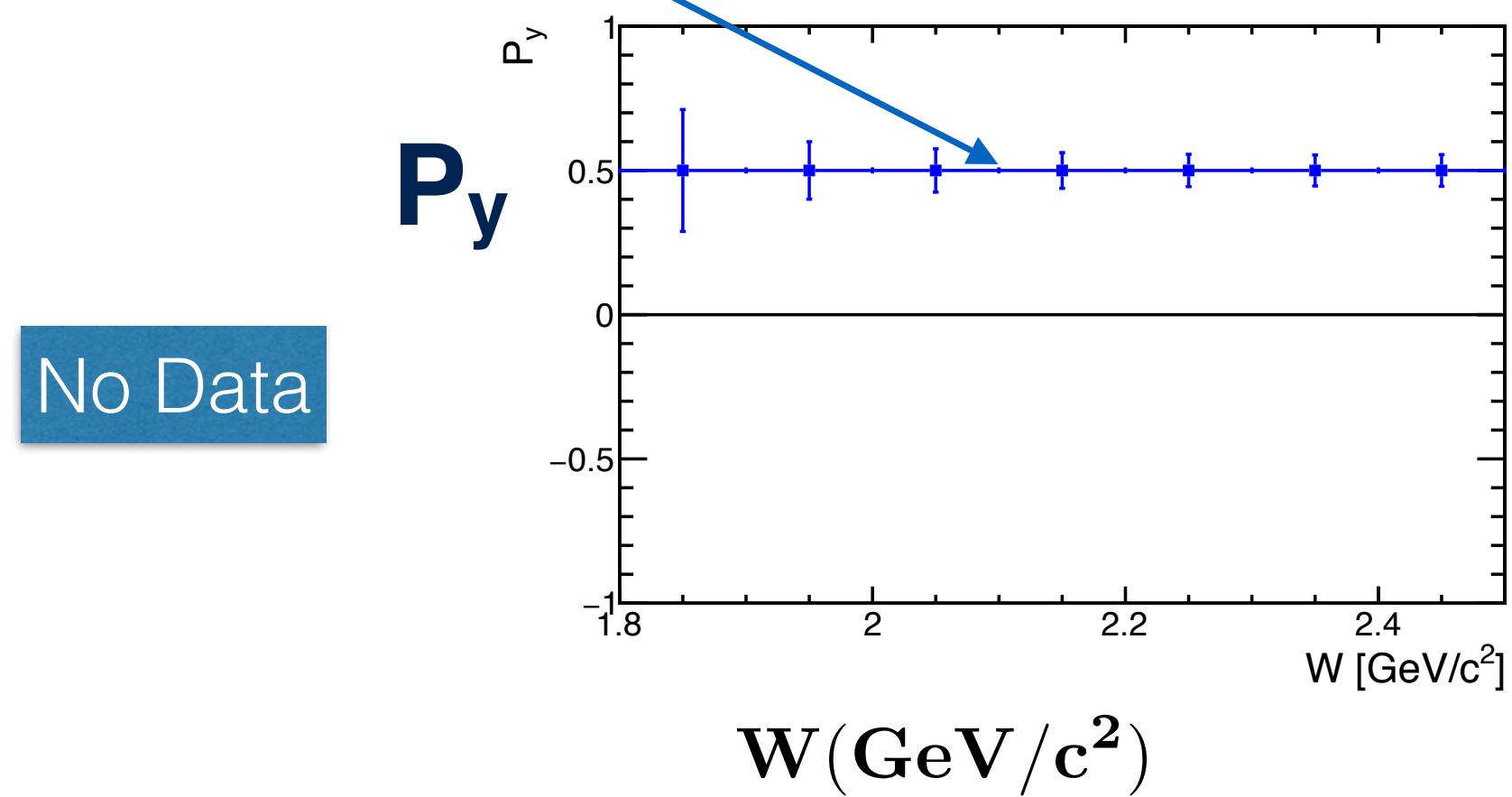
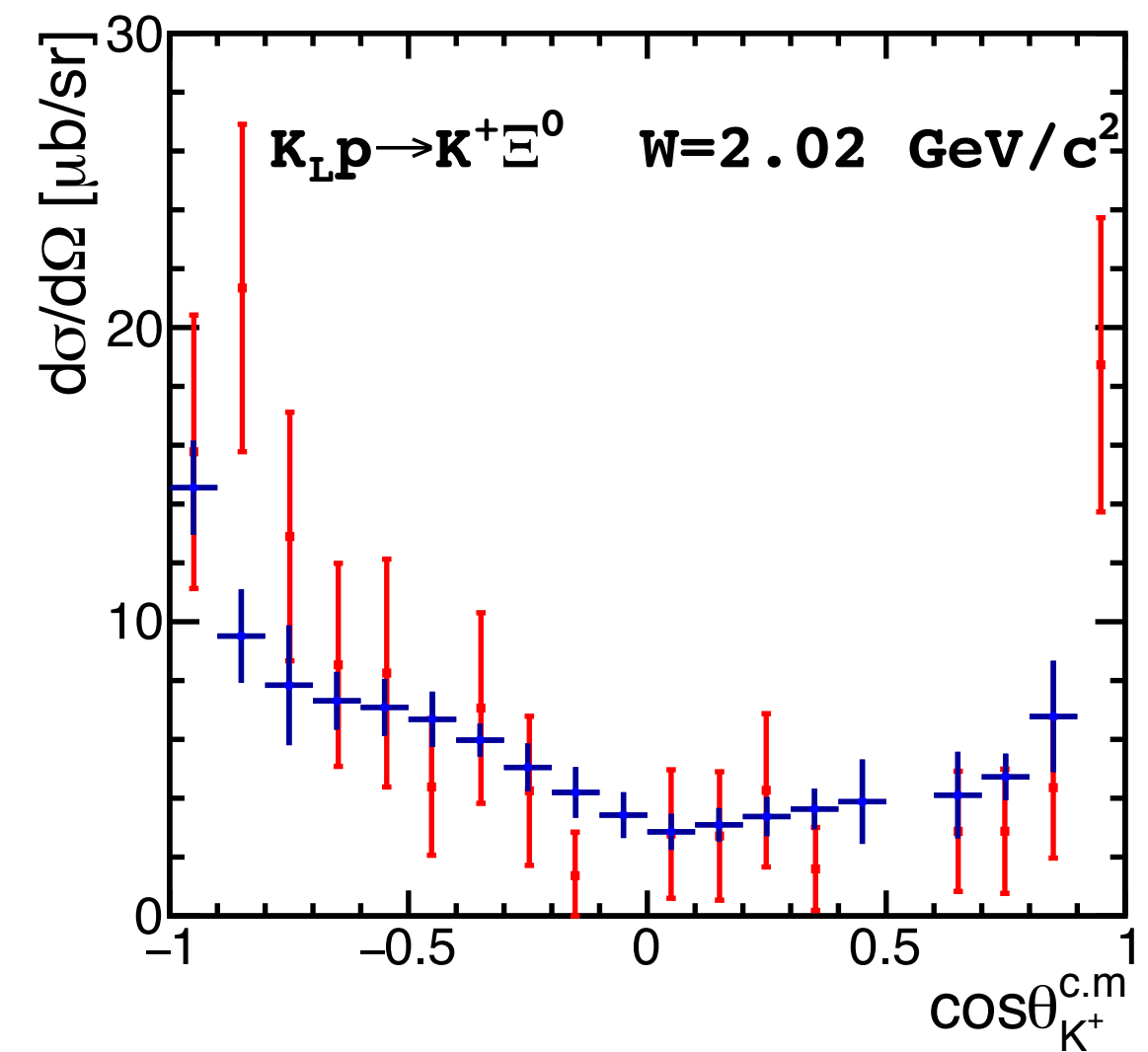
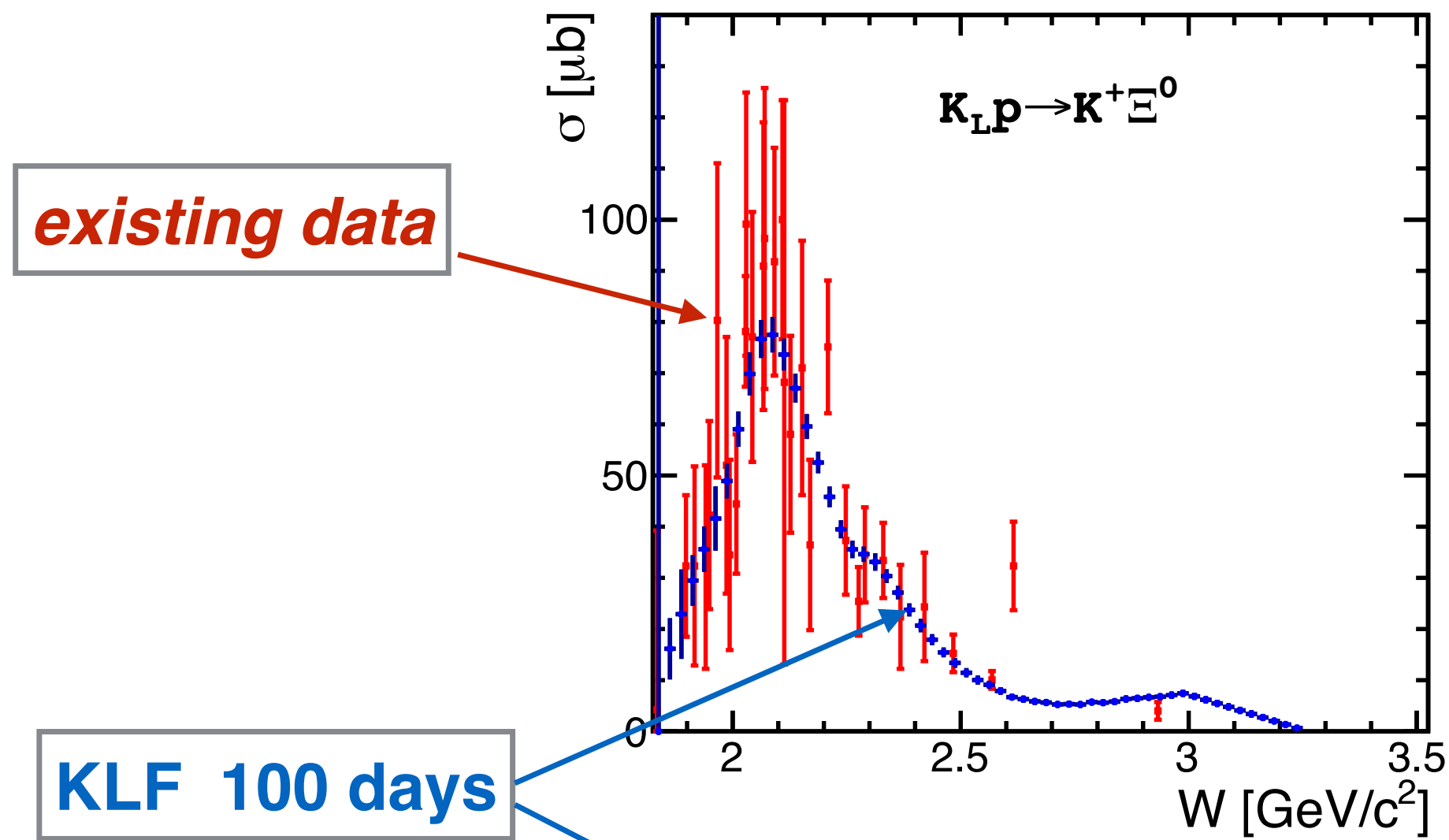

Figure 30: Left: Time resolution (σ_t) for K_L beam as a function of K_L -momentum. Middle: Momentum resolution (σ_p/p) as a function of momentum (note, log scale). Right: Energy resolution (σ_W) as a function of energy. The dashed line shows approximate W resolution from reconstruction of the final-state particles.

We can do it, but why should we?

- **Why to use kaon beam? What is the advantage compared to electrons or photons?**
- **What is so special about K-long compared to charged kaon beams?**
- **What is the advantage of producing secondary kaon beam with EM probe, compared to the proton beam?**
- **How much CEBAF accelerator could make a breakthrough compared to previous results at SLAC?**
- **Why to do this experiment, what are we going to learn?**
- **How will it affect our knowledge on hyperon spectroscopy?**
- **What are we going to learn about strange meson spectroscopy ?**
- **Many more questions - some constructive and some less so - answers to which shaped the approved proposal.**

Measurements on Proton Target



Bonn-Gatchina PWA

Total Cross Section $K_L p \rightarrow K^+ \Xi^0$

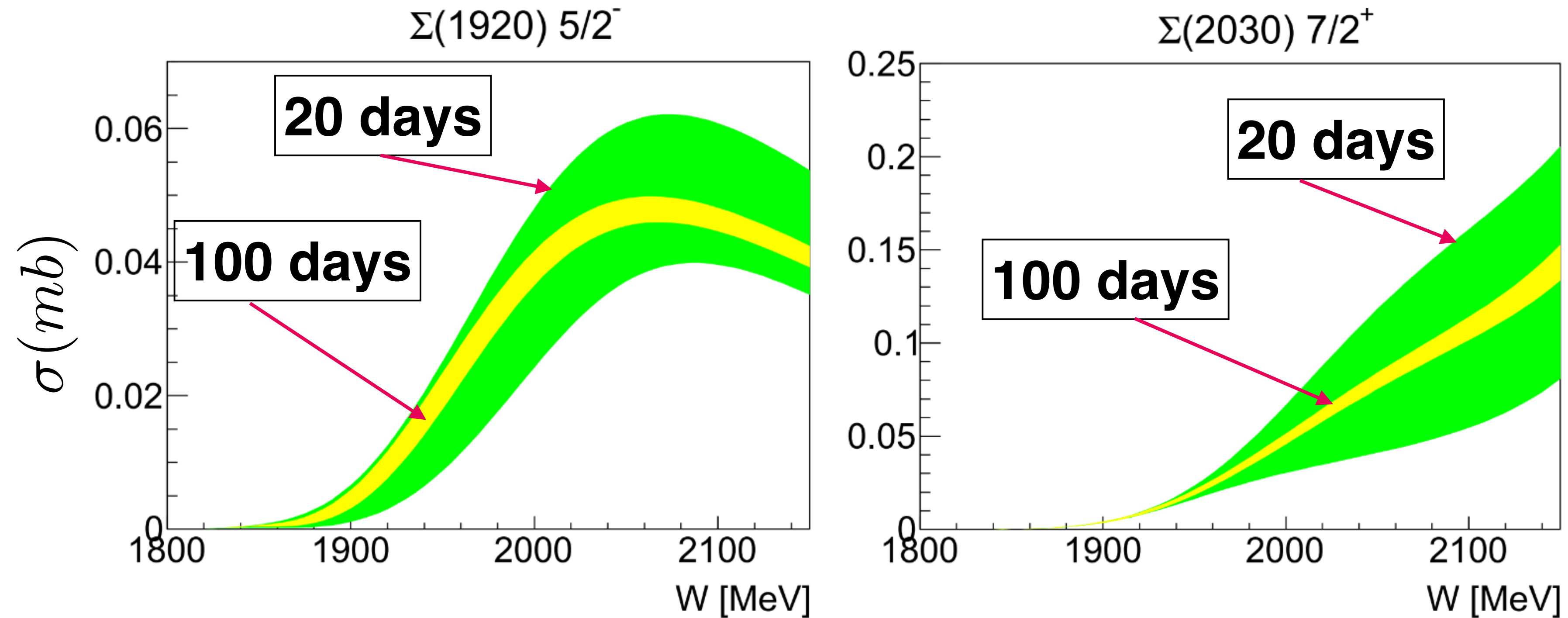

Need 100 days of running to get precise solution

Bonn-Gatchina PWA

Diff. Cross Section

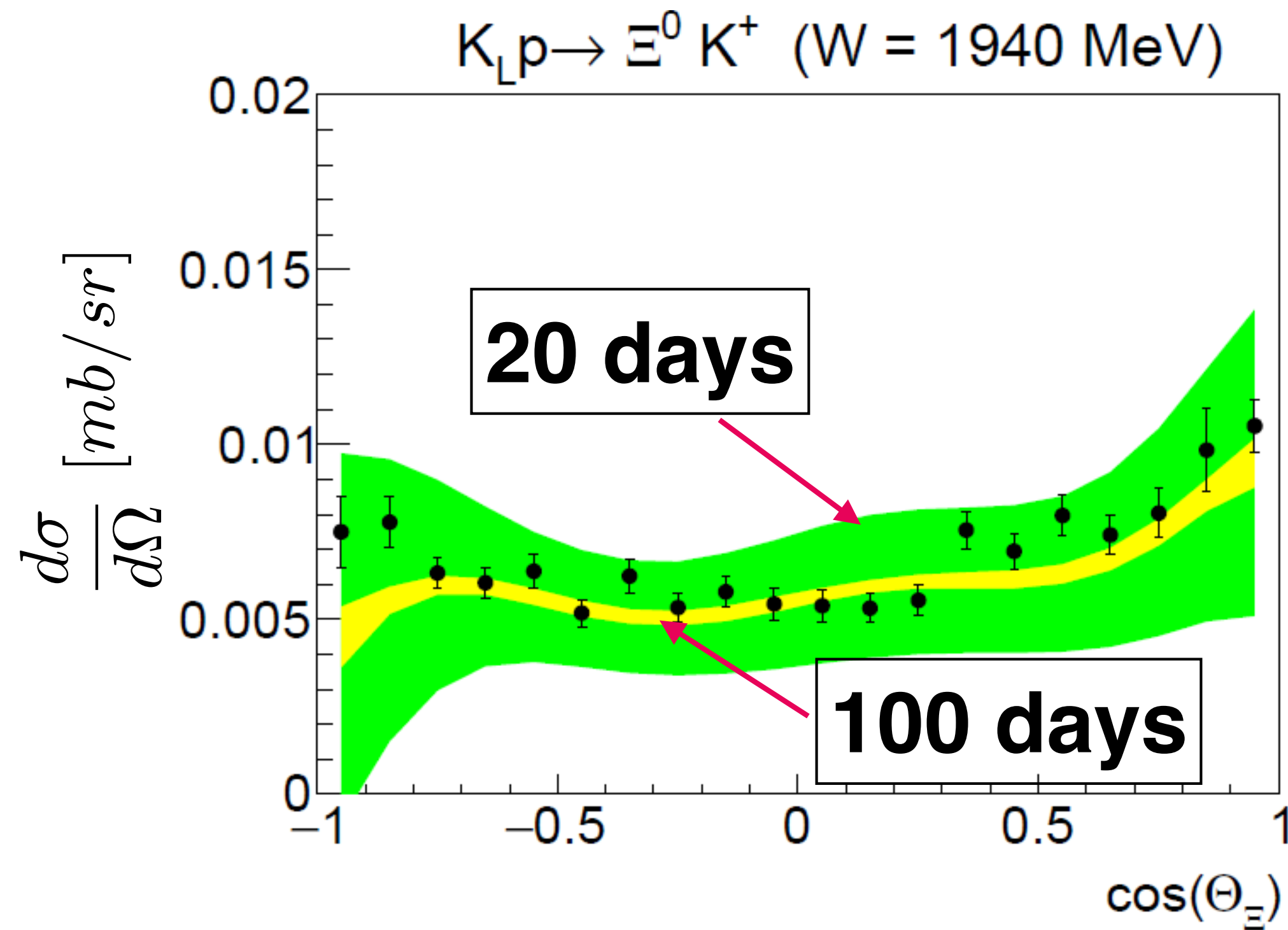

Polarization

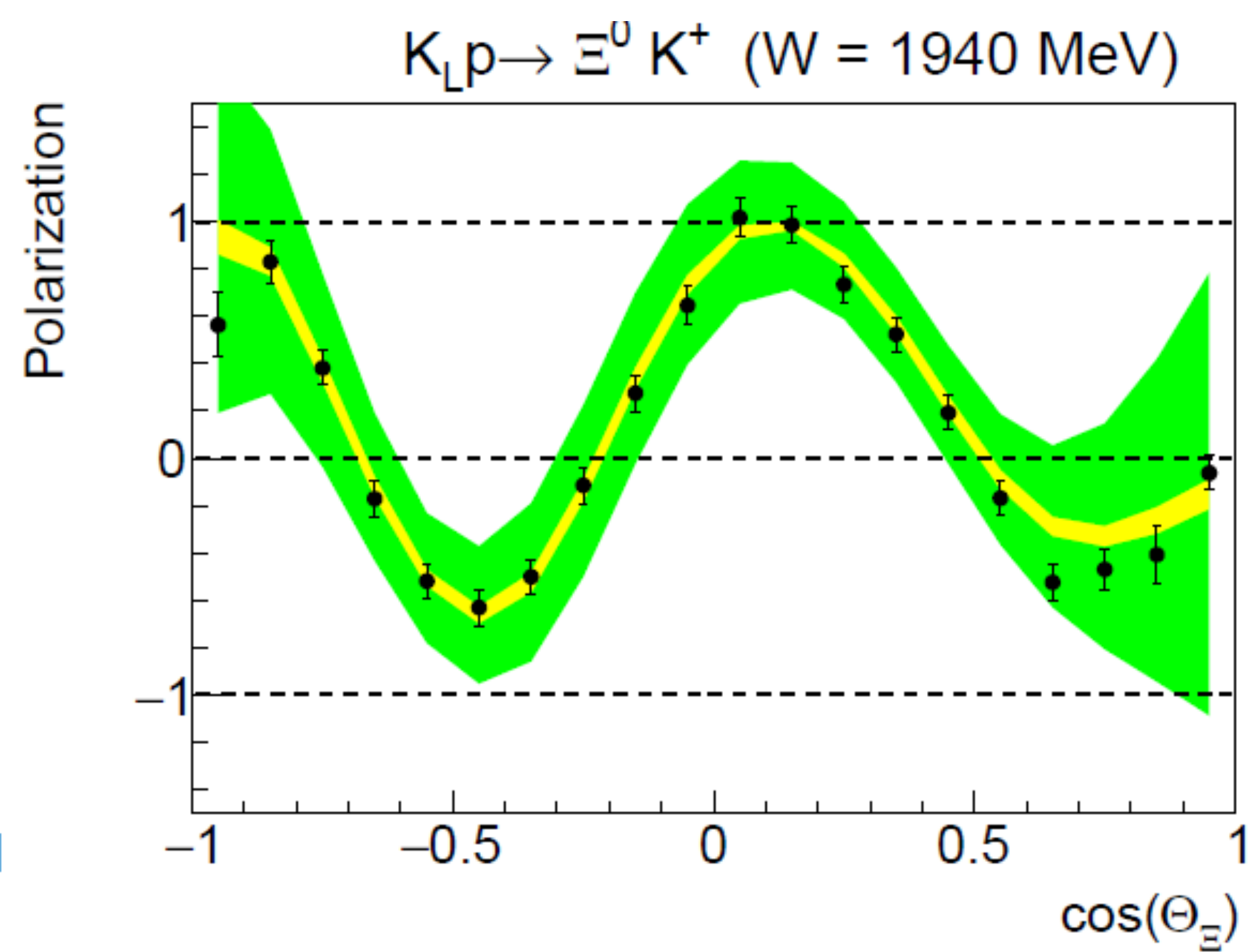

Need **100 days of running** to get precise solution

Bonn-Gatchina PWA

Diff. Cross Section

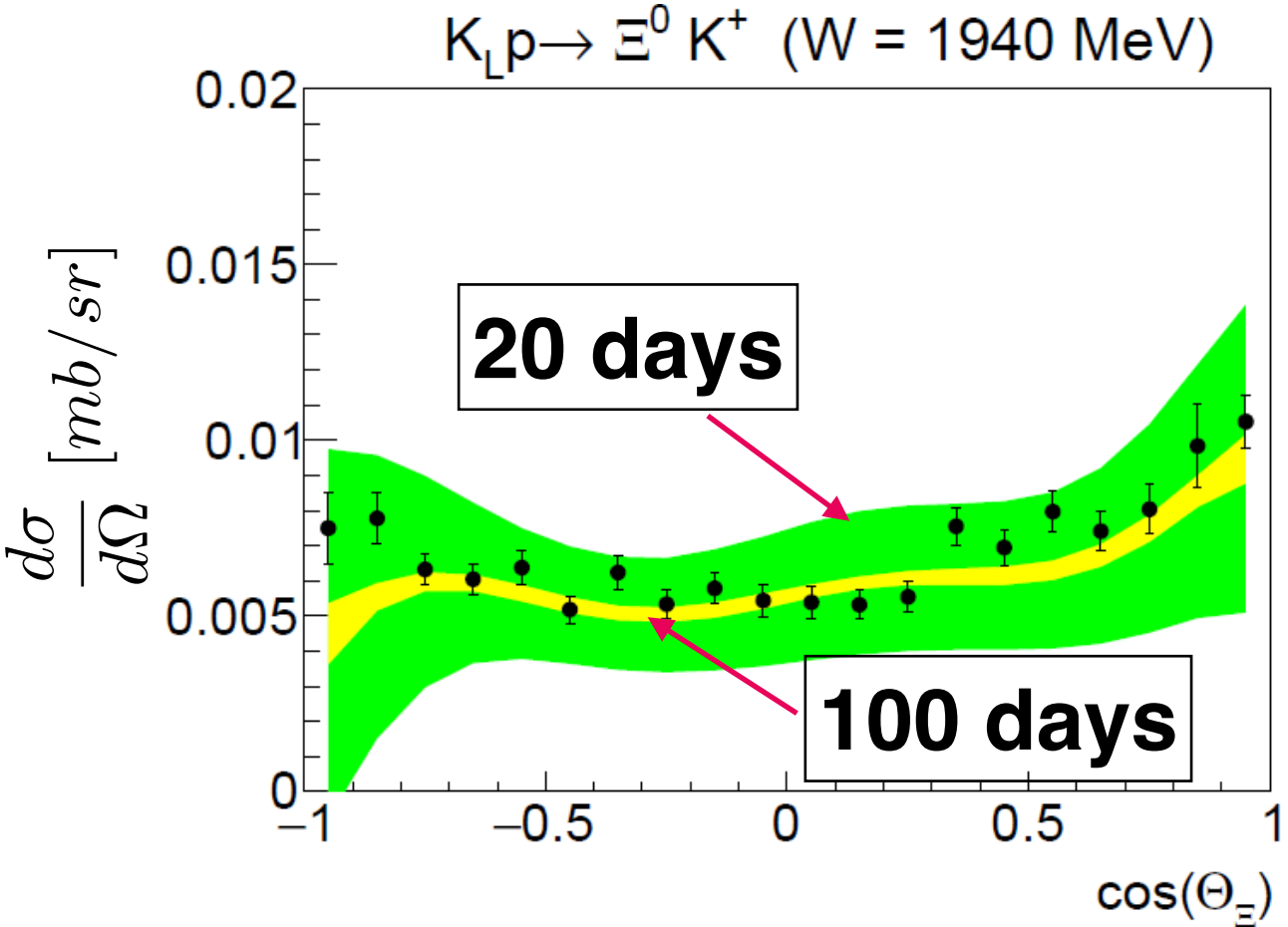

Polarization

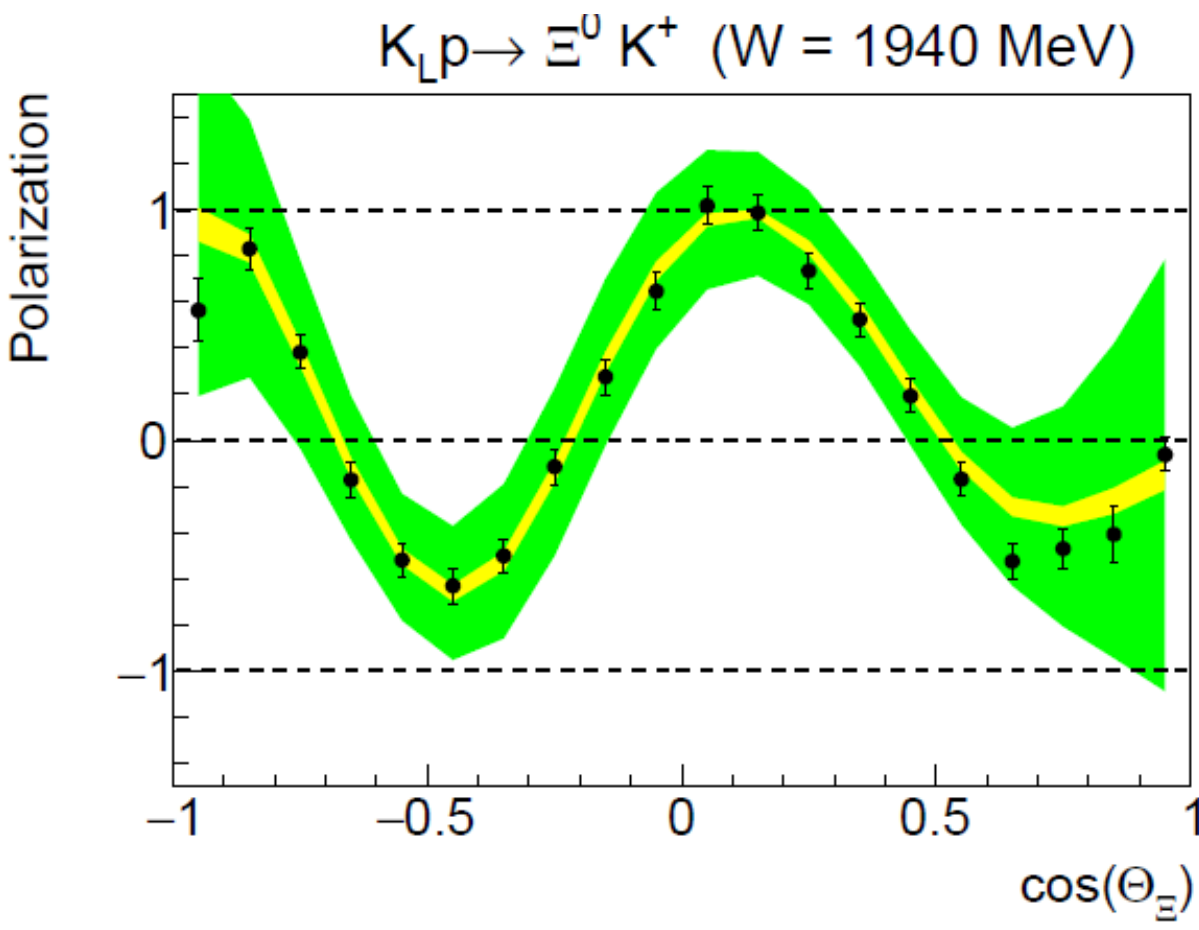

Need 100 days of running to get precise solution

Search for Hyperon Resonances with PWA

For Scattering experiments on both proton & neutron targets one needs to determine:

- differential cross sections**
- self polarization of strange hyperons**
- perform Partial Wave Analysis**

- look for poles in complex energy plane**
- identify excited hyperons with masses up to 2500 MeV
In a formation and production reactions**

$$\Lambda^*, \Sigma^*, \Xi^* \text{ \& \ } \Omega^*$$

we use KN scattering data with statistics generated according to expected K-long Facility (KLF) data for 100 days to show PWA sensitivity to obtain results close to the best fit

Strange Meson Spectroscopy

Possible channels with proton and deuterium target and corresponding CG coefficient.

$$K_L p \rightarrow K^\pm \pi^\mp p = \langle K_L \pi^0 | K^\pm \pi^\mp \rangle = \pm \frac{1}{3}(T^{\frac{1}{2}} - T^{\frac{3}{2}}),$$

$$K_L p \rightarrow K_L \pi^0 p = \langle K_L \pi^0 | K_L \pi^0 \rangle = \frac{1}{3}(T^{\frac{1}{2}} + 2T^{\frac{3}{2}}),$$

$$K_L p \rightarrow K_{(L,S)} \pi^+ n = \langle K_L \pi^+ | K_L \pi^+ \rangle = \frac{1}{3}(T^{\frac{1}{2}} + 2T^{\frac{3}{2}}),$$

$$K_L p \rightarrow K^+ \pi^0 n = \langle K_L \pi^+ | K^+ \pi^0 \rangle = -\frac{1}{3}(T^{\frac{1}{2}} - T^{\frac{3}{2}}),$$

$$K_L p \rightarrow K^- \pi^0 \Delta^{++} = \langle K_L \pi^- | K^- \pi^0 \rangle = \frac{1}{3}(T^{\frac{1}{2}} - T^{\frac{3}{2}}),$$

$$K_L n \rightarrow K^\pm \pi^\mp n = \langle K_L \pi^0 | K^\pm \pi^\mp \rangle = \pm \frac{1}{3}(T^{\frac{1}{2}} - T^{\frac{3}{2}}),$$

$$K_L p \rightarrow K_{(L,S)} \pi^- \Delta^{++} = \langle K_L \pi^- | K_L \pi^- \rangle = \frac{1}{3}(T^{\frac{1}{2}} + 2T^{\frac{3}{2}}),$$

$$K_L n \rightarrow K_L \pi^0 n = \langle K_L \pi^0 | K_L \pi^0 \rangle = \frac{1}{3}(T^{\frac{1}{2}} + 2T^{\frac{3}{2}}),$$

$$K_L n \rightarrow K_{(L,S)} \pi^\pm \Delta^\mp = \langle K_L \pi^\pm | K_L \pi^\pm \rangle = \frac{1}{3}(T^{\frac{1}{2}} + 2T^{\frac{3}{2}}),$$

$$K_L n \rightarrow K^\pm \pi^0 \Delta^\mp = \langle K_L \pi^\pm | K^\pm \pi^0 \rangle = \pm \frac{1}{3}(T^{\frac{1}{2}} - T^{\frac{3}{2}}),$$

Strange Meson Spectroscopy

$K\pi$ Scattering

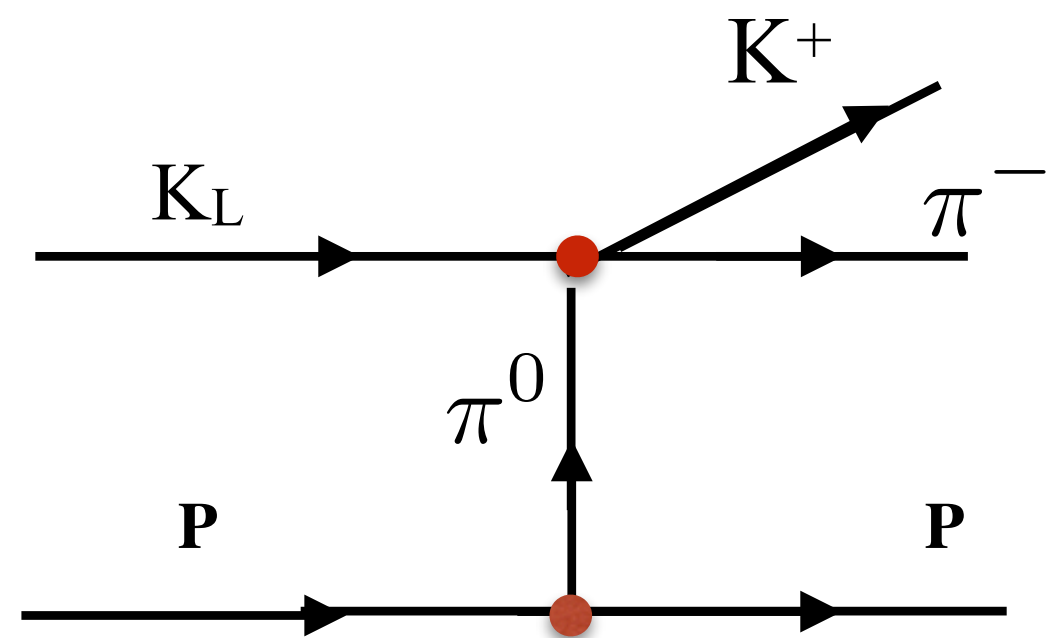

$$\frac{1}{3}(T^{1/2} - T^{3/2})$$

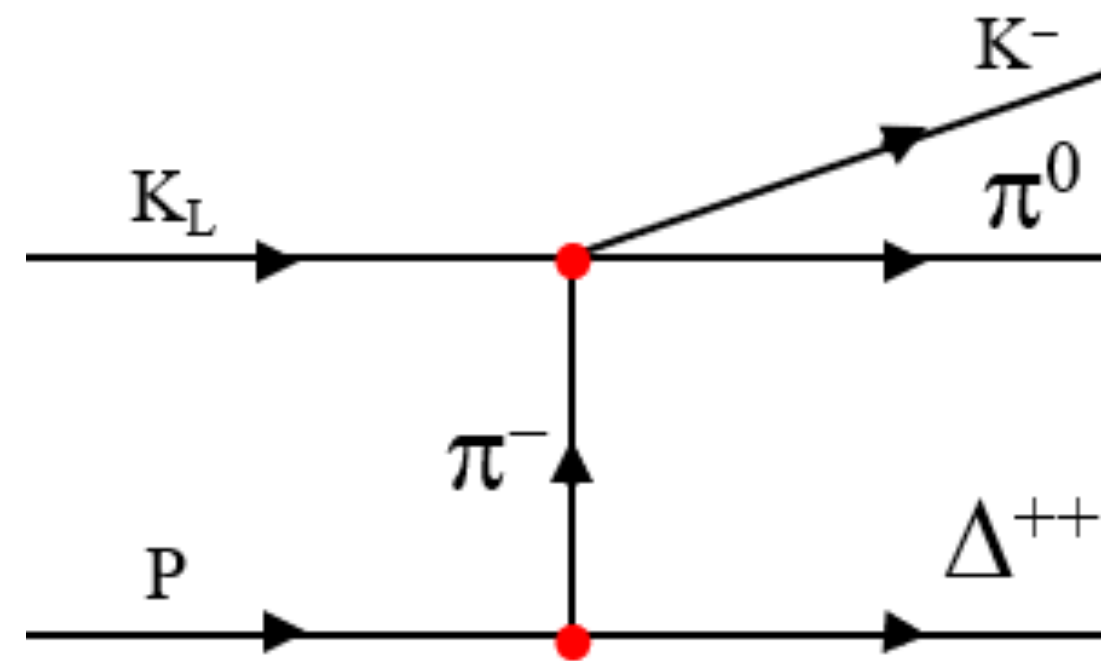

$$\frac{1}{3}(T^{1/2} - T^{3/2})$$

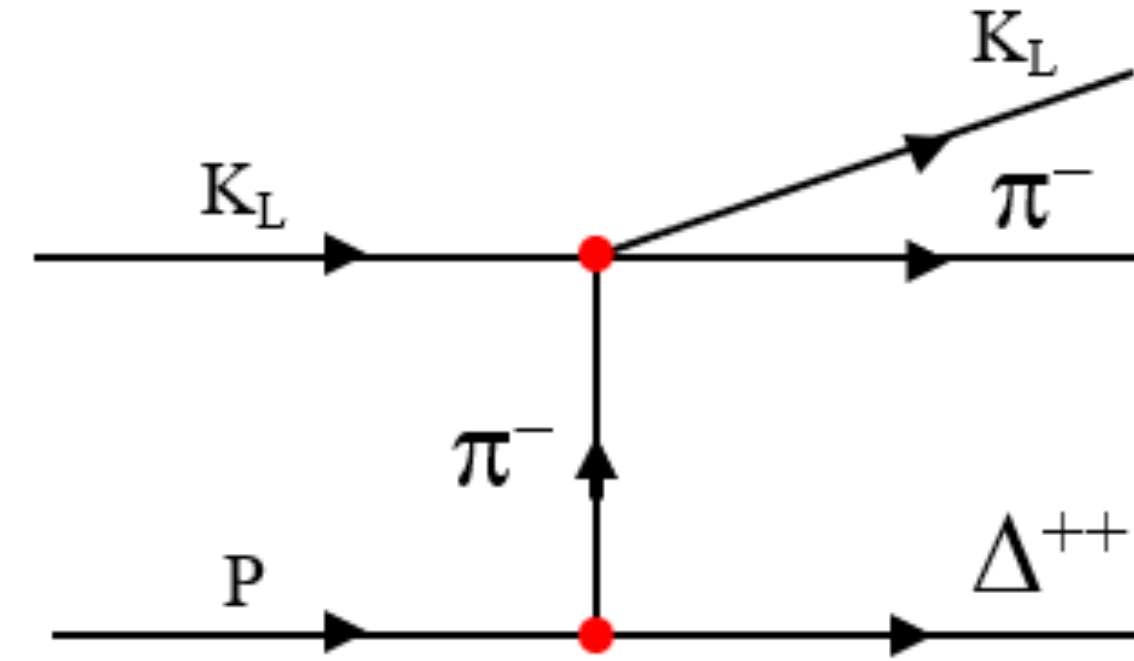

$$\frac{1}{3}(T^{1/2} + T^{3/2})$$

Proposed Measurements

SLAC

$$K^- \pi^+ \rightarrow K^- \pi^+$$

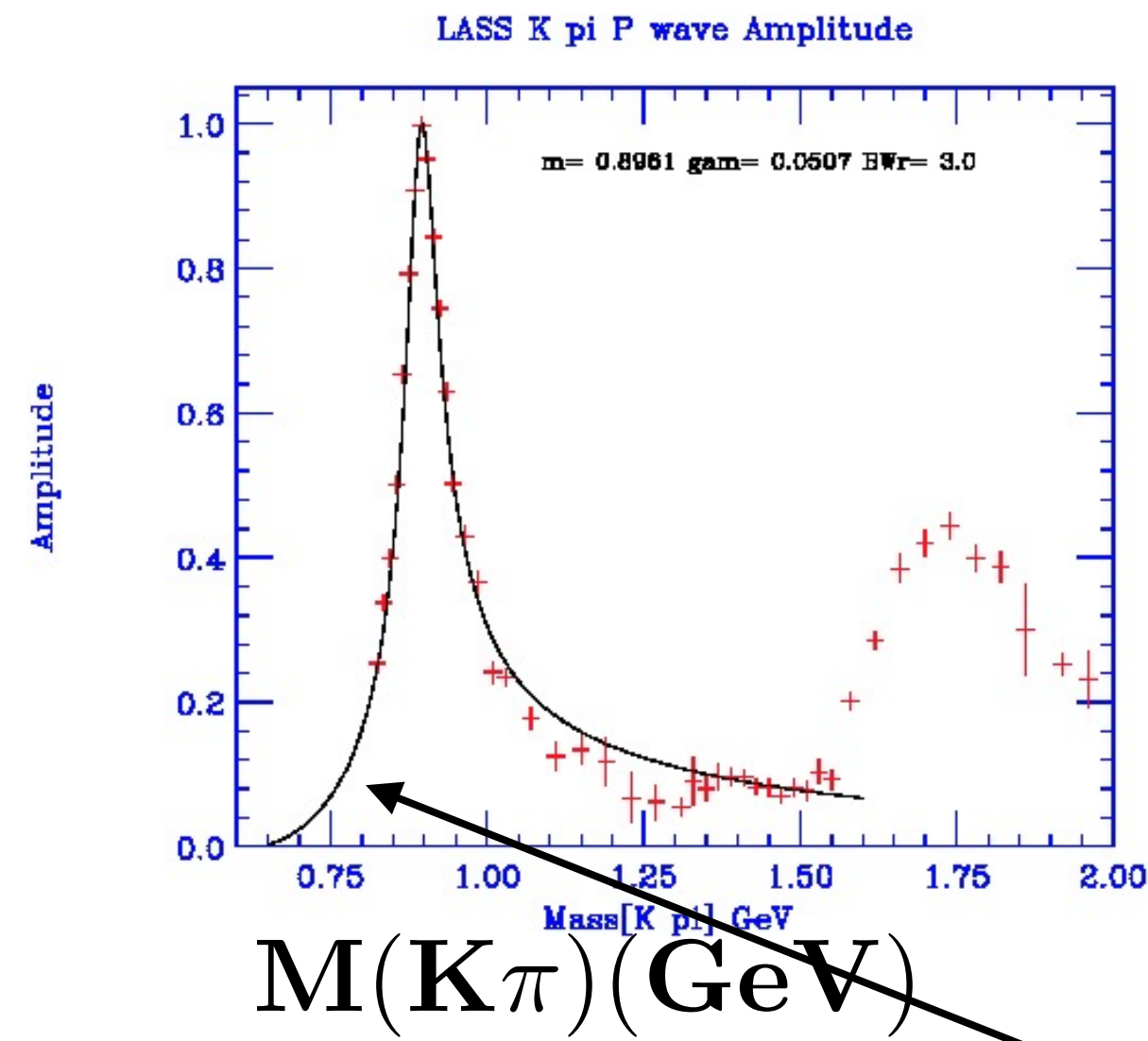

Belle

$$\tau \rightarrow K \pi \nu_\tau$$

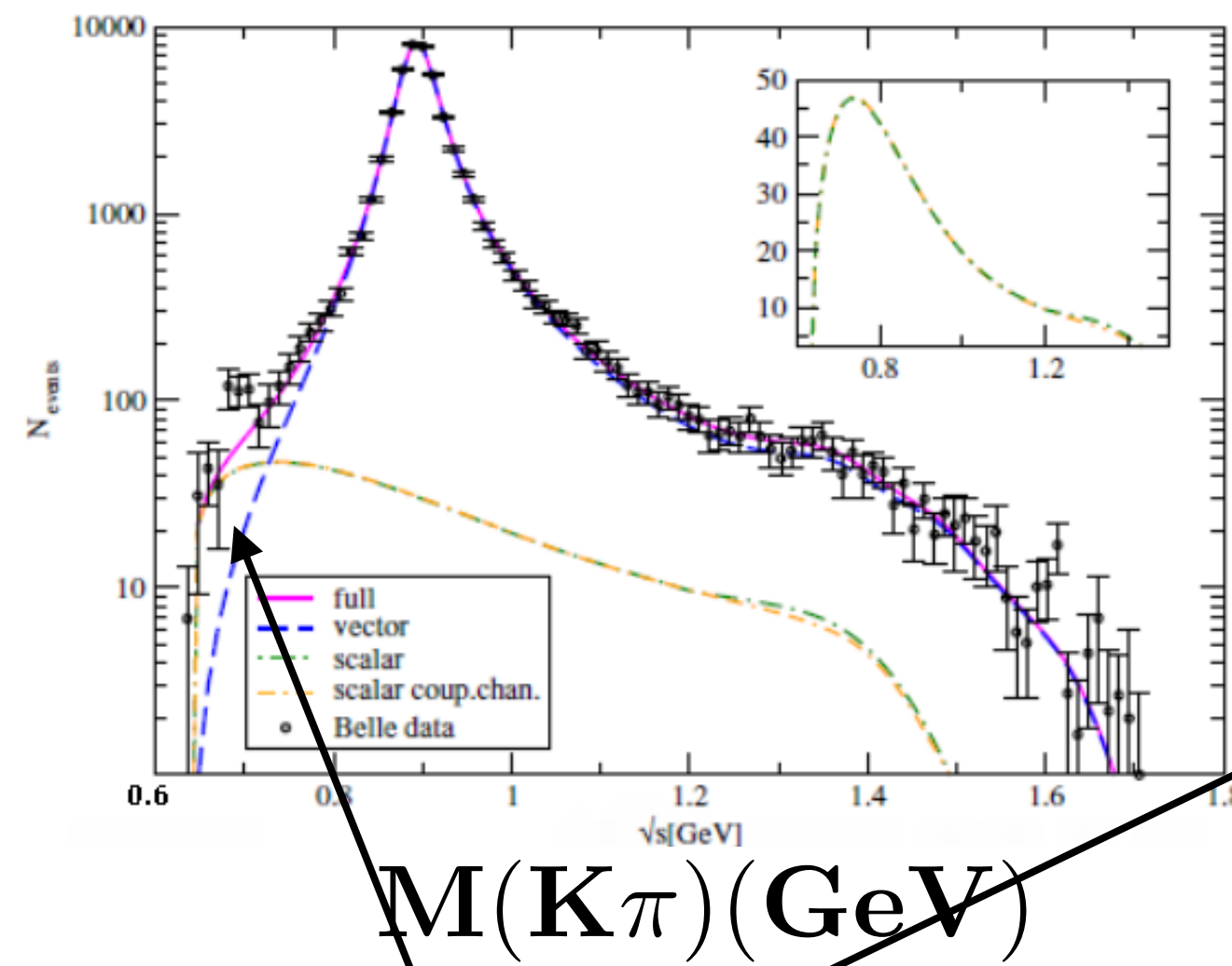

KLF

$$K_L \pi^0 \rightarrow K^+ \pi^-$$

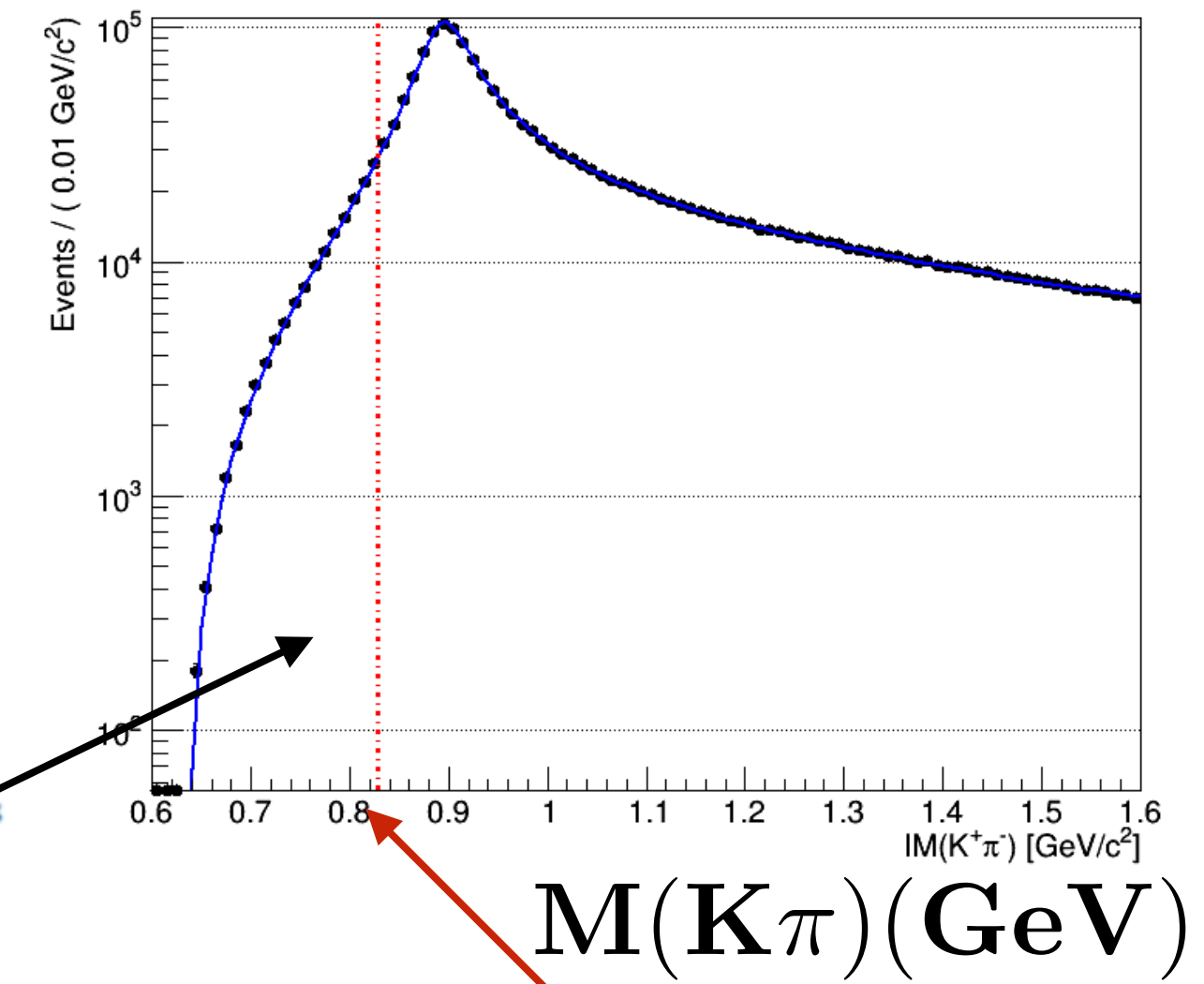

region of $\mathcal{K}(800)$

SLAC Lower limit

KLF 100 Days

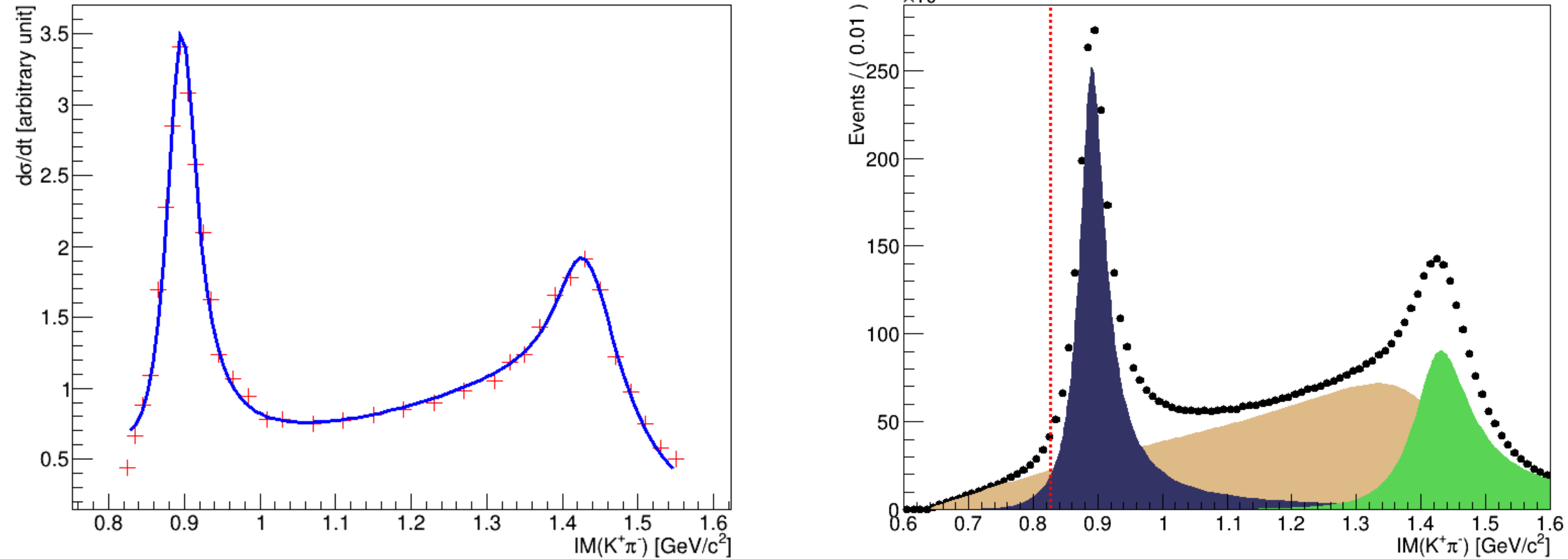
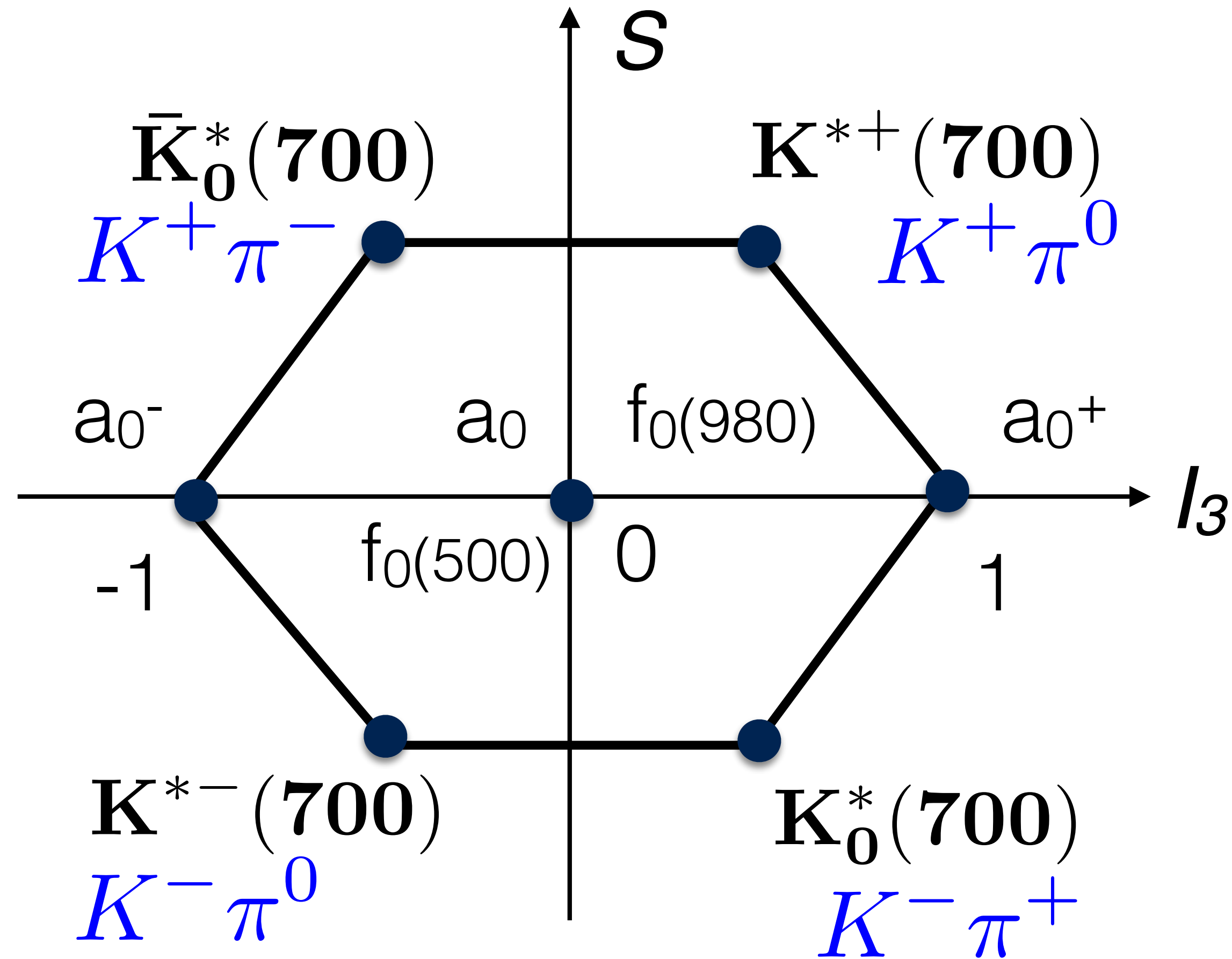

Figure 11: Left: Cross section of $K^-p \rightarrow K^+\pi^-n$ as a function of the invariant mass from LASS results [27]. The blue line is the fit to the cross section using composite model containing two RBWs, spin-1 and spin-2, and S -wave LASS parameterization. Right: Expected distribution of the $K^+\pi^-$ invariant mass below 1.6 GeV from KLF after 100 days of running. The dark blue function represents the $K^+\pi^-$ P -wave, light brown the S -wave and green the D -wave. The dashed line represents the threshold of $K\pi$ invariant mass in LASS results [27].

Scalar Meson Nonet

$$J^{PC} = 0^{++}$$



Four states called \mathcal{K}

still need further confirmation(PDG)

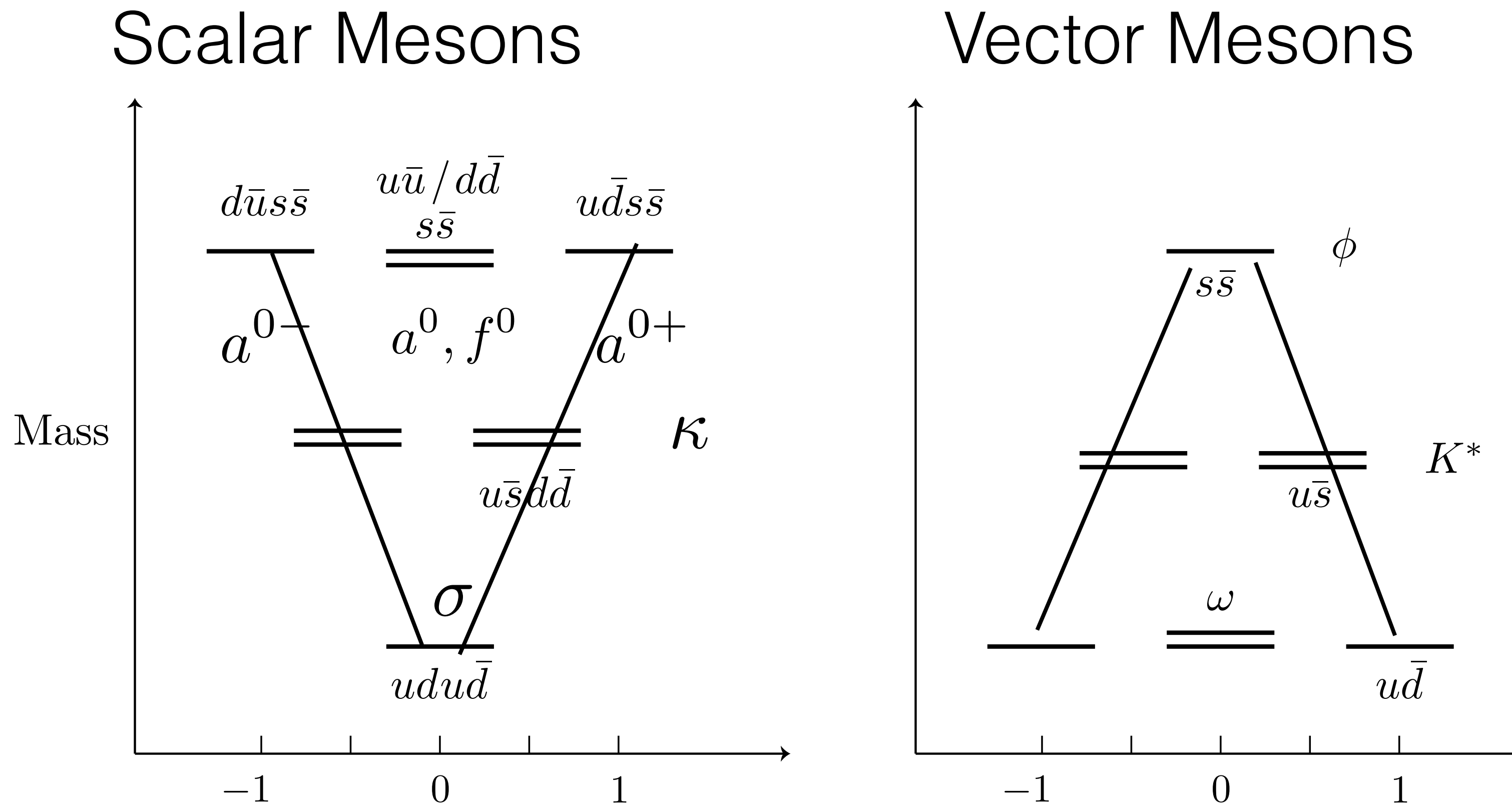
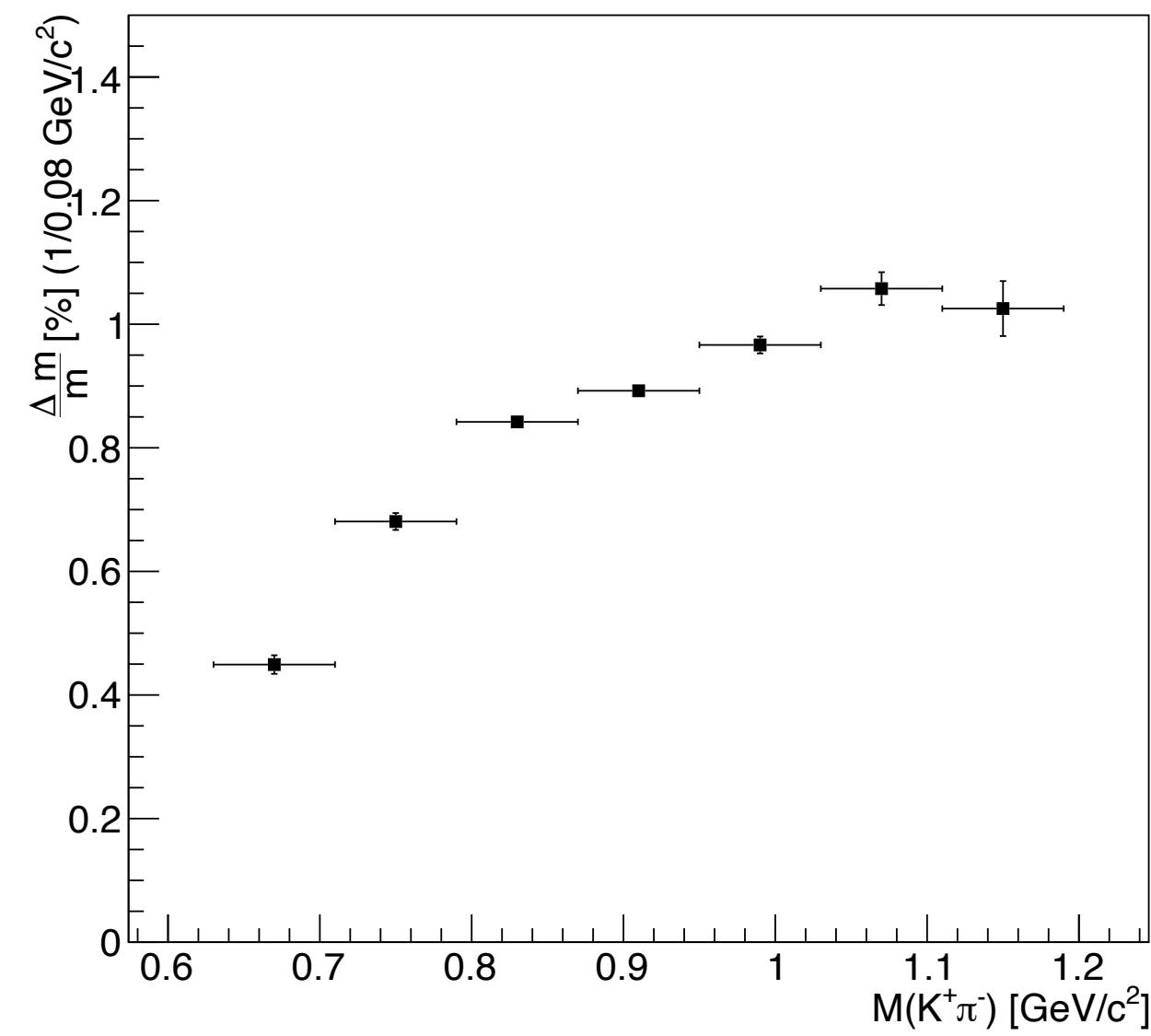

Figure 6. A cartoon representation of the masses of a $\bar{q}q\bar{q}q$ nonet compared with a $\bar{q}q$

Very different mass hierarchy
Possibly suggesting 4q tetraquark

Invariant mass resolution $\Delta m/m$ (%)



$K^+\pi^-$

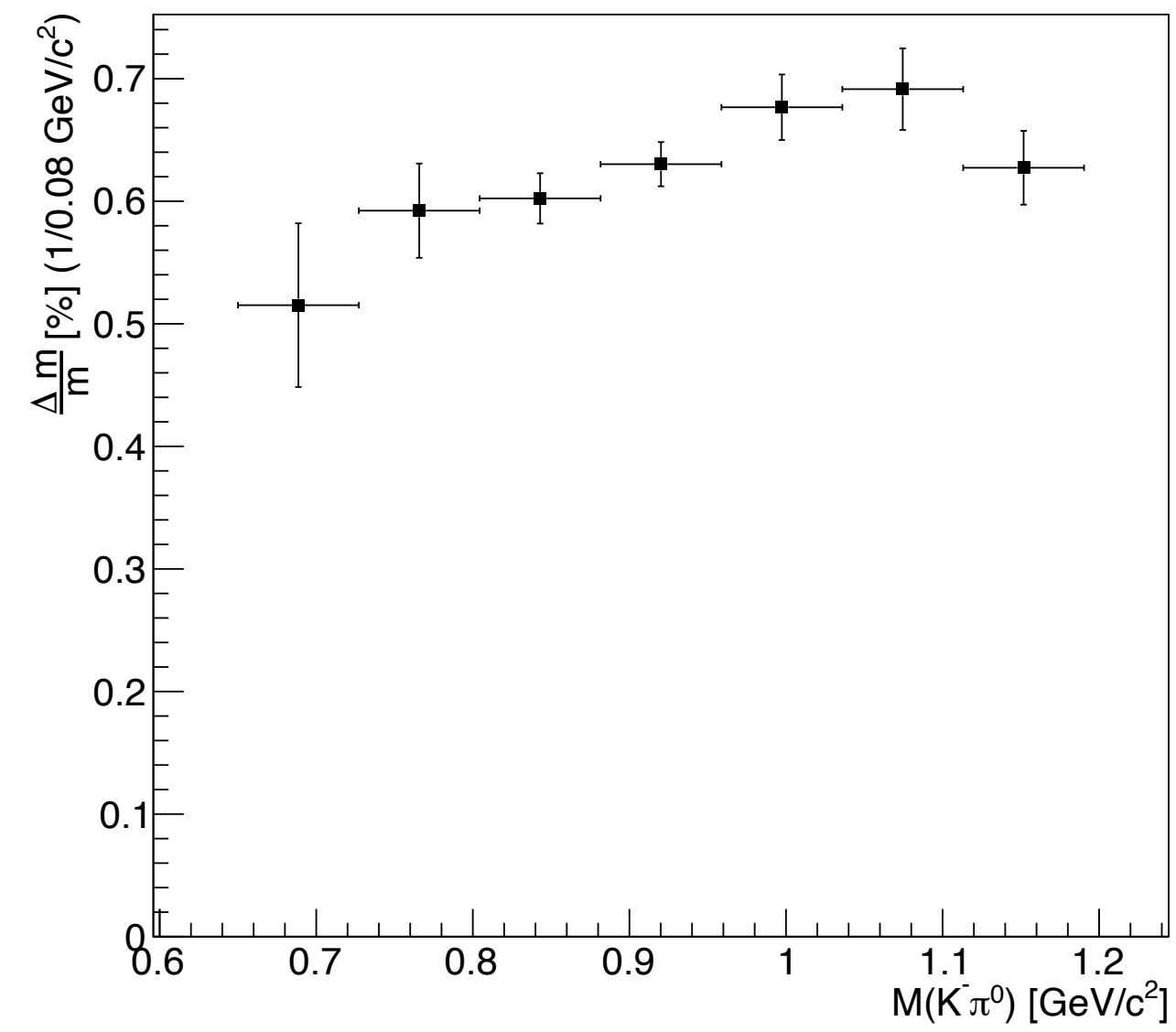

$K^-\pi^0$

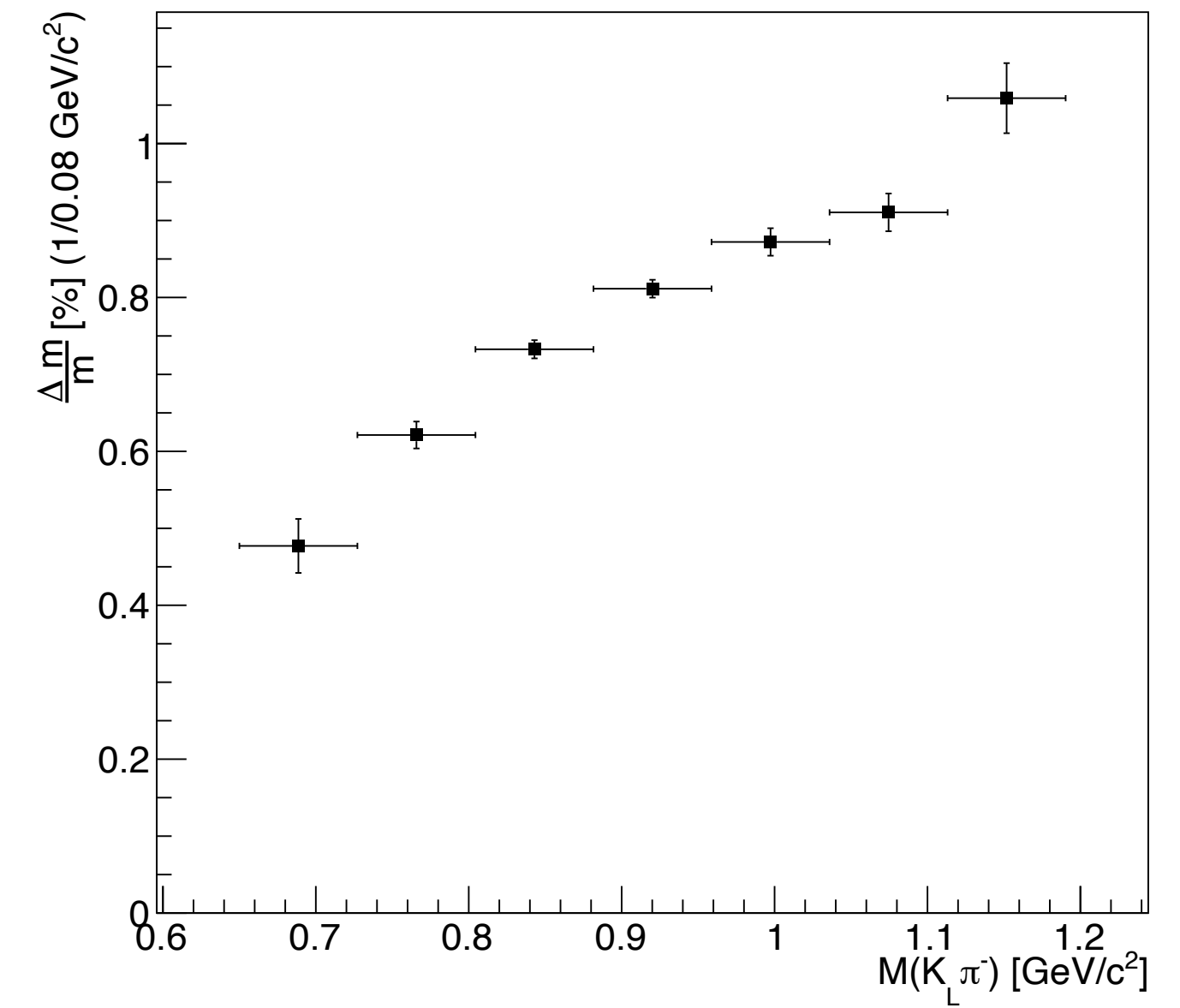

$K_L\pi^-$

Below 1% in all cases

Projected Measurements

$I=3/2+1/2$

S -wave

SLAC Data

$$K^\pm p \rightarrow K^\pm \pi^+ n$$

$$K^\pm p \rightarrow K^\pm \pi^- \Delta^{++}$$

Estabrooks(1978)

$$K^- p \rightarrow K^- \pi^+ n$$

Aston(1988)

**KLF
(100 days)**

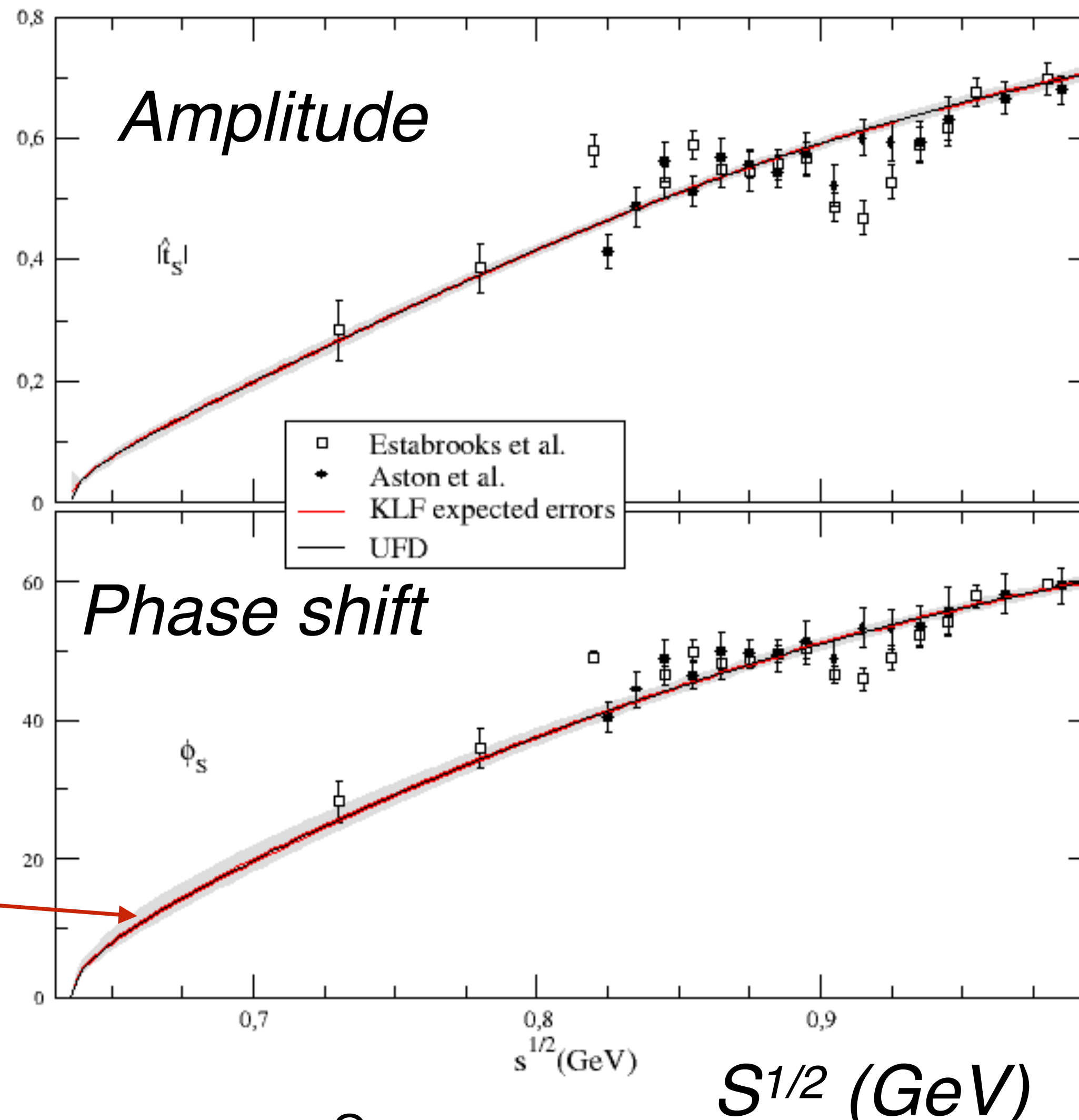

$I=3/2$ S -wave

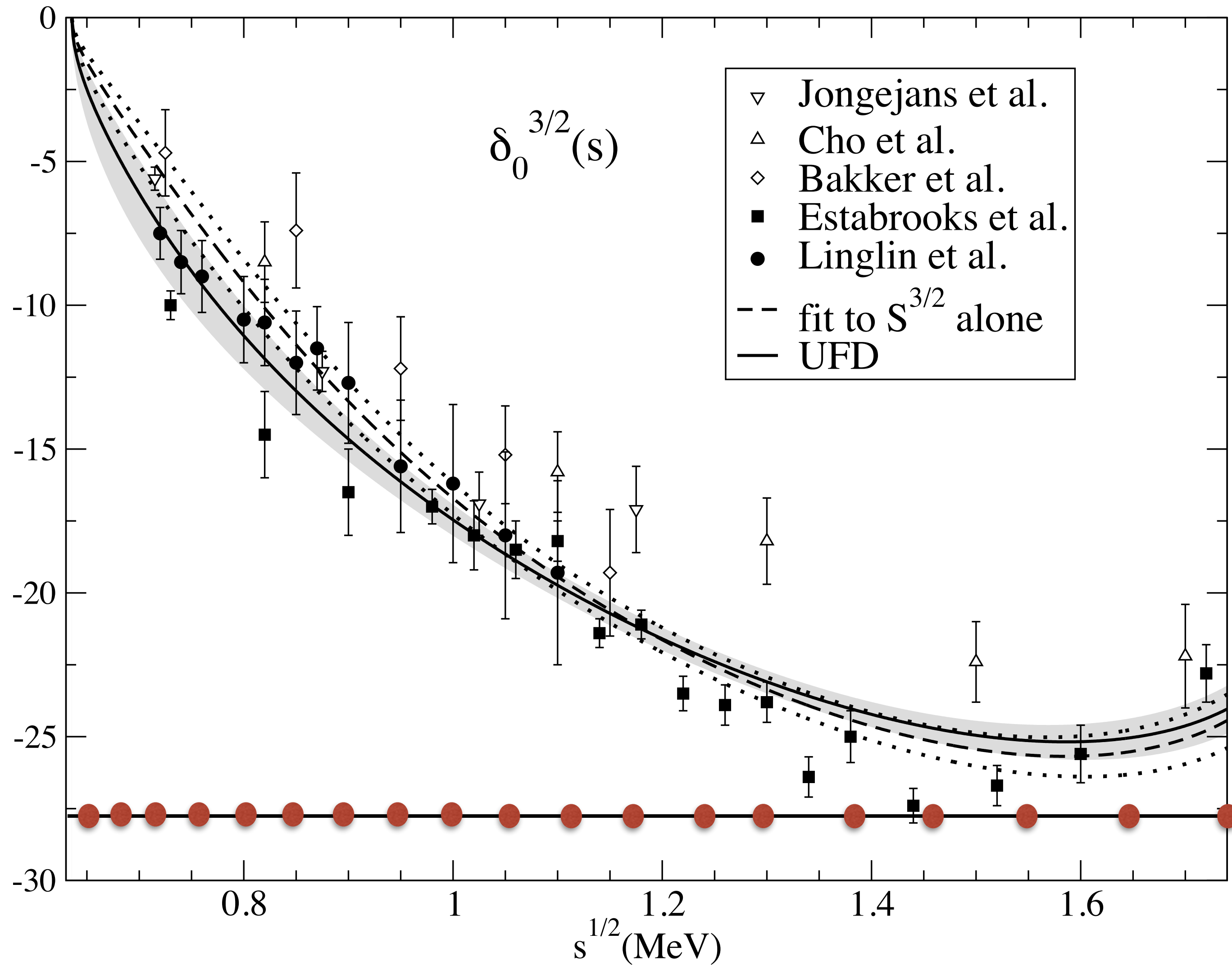

4.25 GeV Saclay
 5.5 GeV CERN
 3.0 GeV ANL
 13.0 GeV SLAC
 14.3 GeV CERN

Estabrooks(1978)

$$K^\pm p \rightarrow K^\pm \pi^+ n$$

$$K^\pm p \rightarrow K^\pm \pi^- \Delta^{++}$$

KLF 100 days

From Pelaez and Rodas paper: PRD93(2016)

100 days KLF

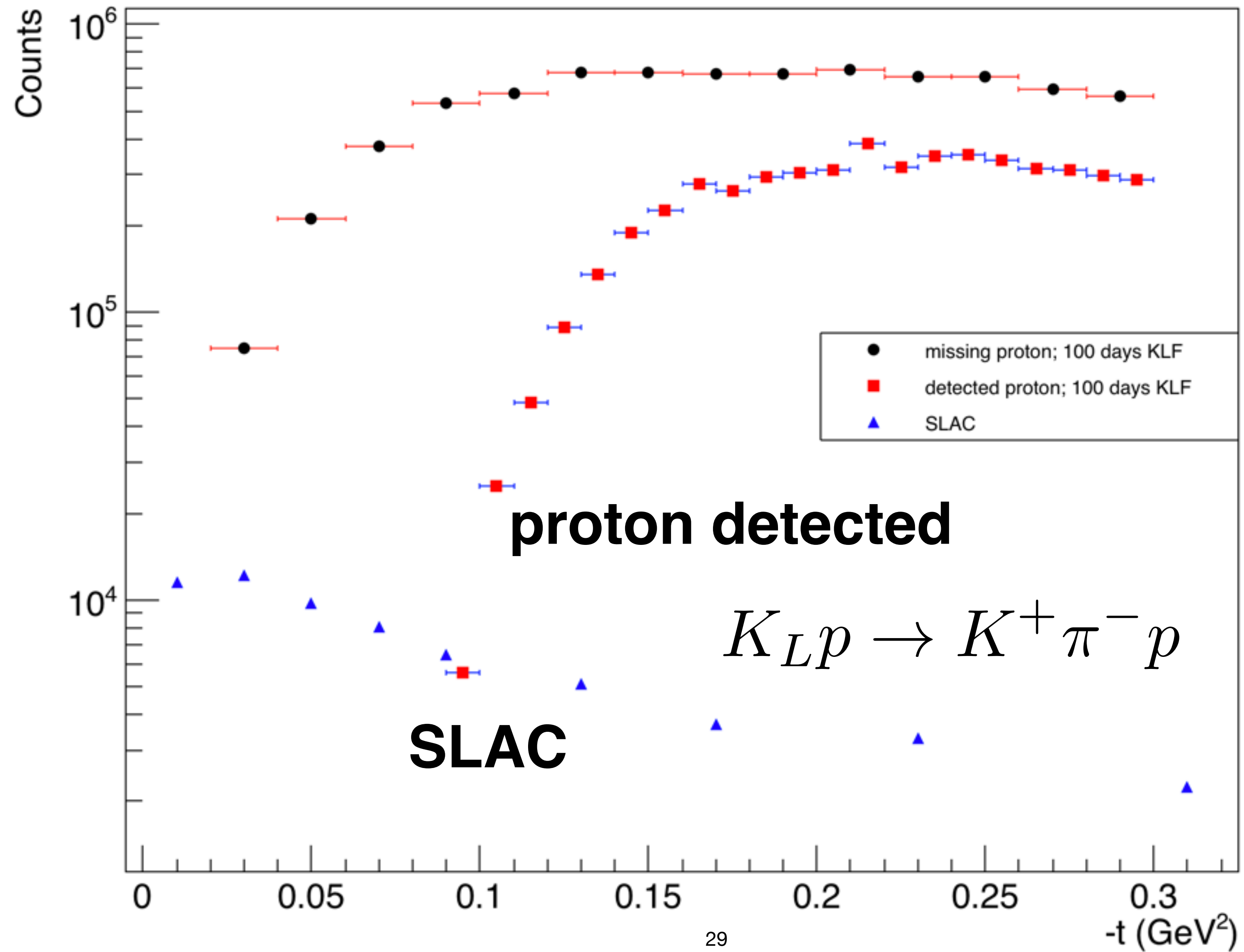

$$K_L p \rightarrow K^{(-,0)} \pi^{(0,-)} \Delta^{++}$$

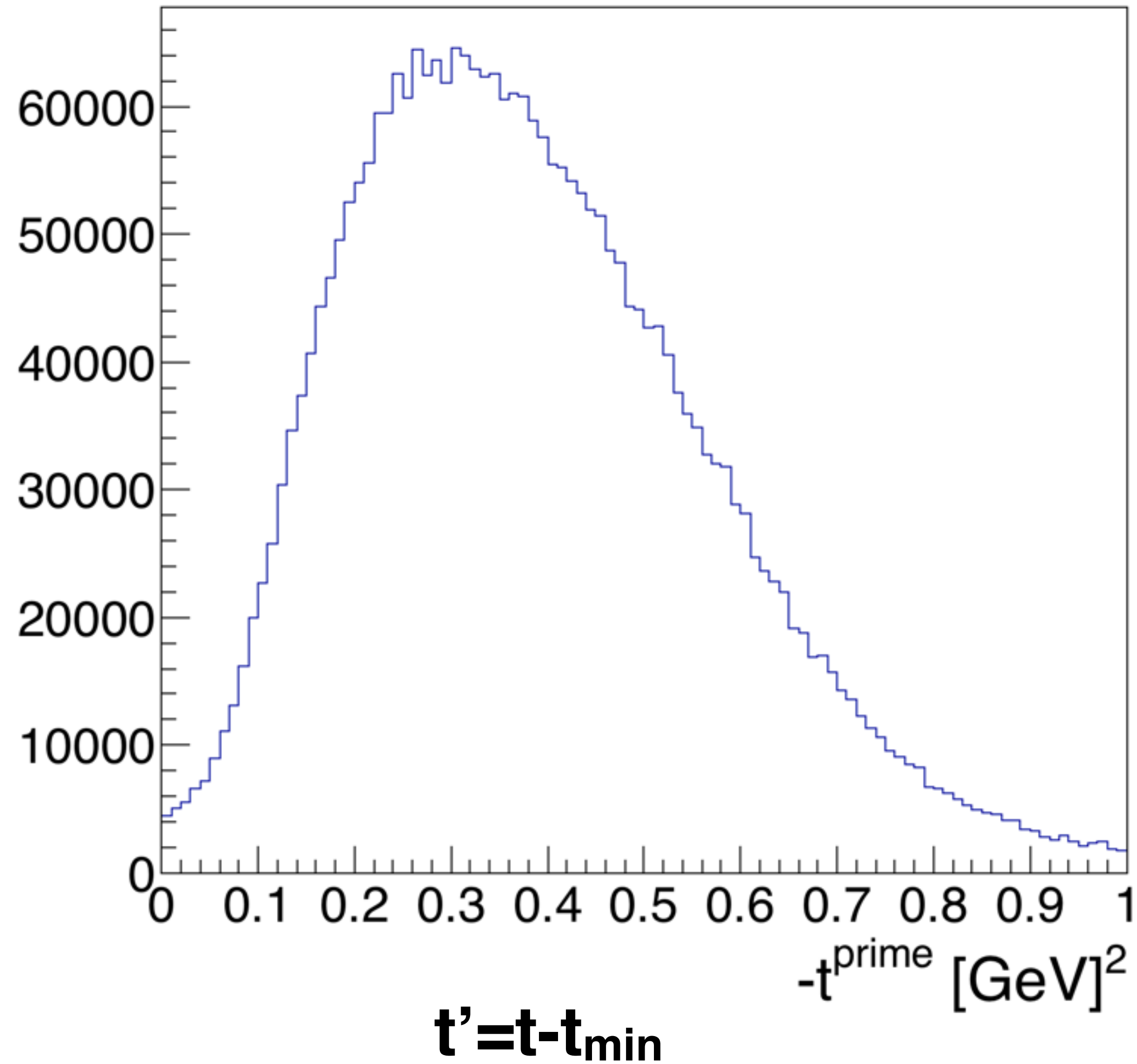

Phase-shift

For $L=0, 1$

$$A^I(\cos\theta_{GJ}, \phi_{GJ}) = \frac{\sqrt{4\pi}}{q_i} \sum_{l,m} a_l^I (2l+1) Y_l^m(\cos\theta_{GJ}, \phi_{GJ})$$

In the elastic region

$$a_L^I = a_L^{I=1/2} + \frac{1}{2} a_L^{I=3/2}$$

$$a_L^I = \sqrt{(2L+1)} \epsilon^I \sin \delta_L^I e^{i\delta_L^I}$$

Results include statistical uncertainty only.

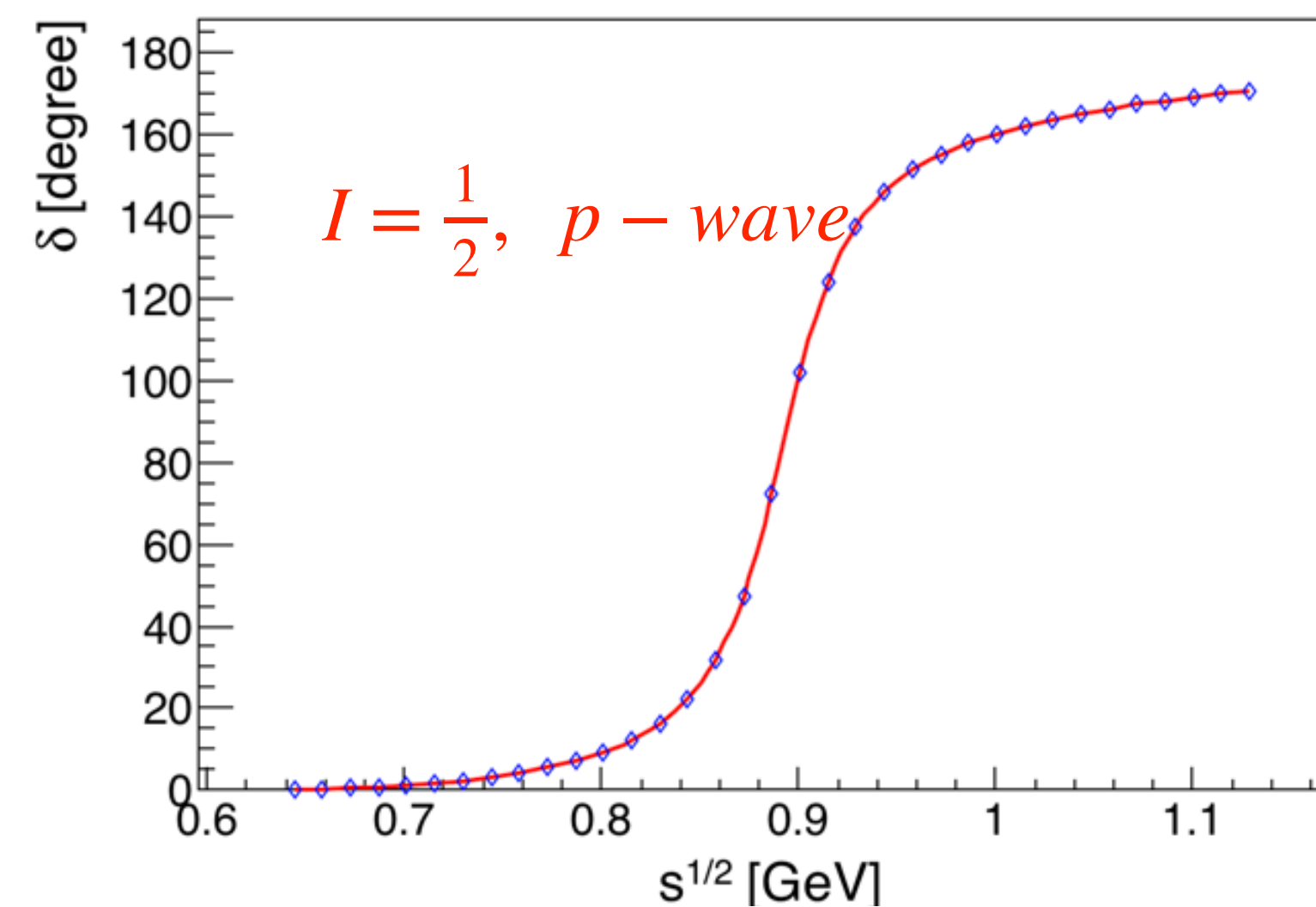
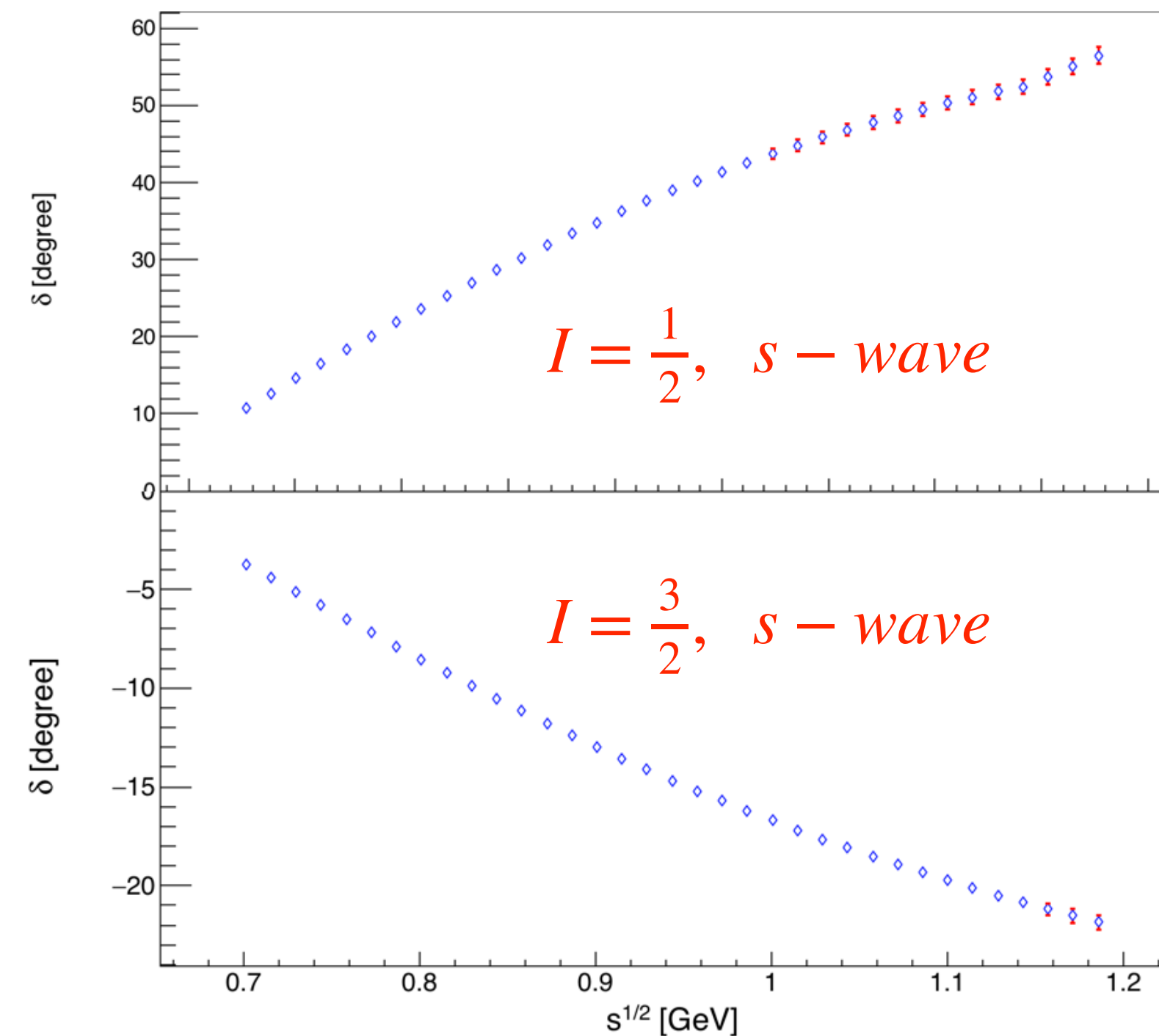

Summary of $K\pi$ Scattering

- The KLF will have a significant impact on our knowledge on $K\pi$ scattering amplitudes
- It will improve on still conflictive determination of heavy K^* 's parameters
- It will help to settle the tension between phenomenological determinations of scattering lengths from data versus ChPT and LQCD
- Finally, and very importantly, it will **reduce the uncertainty in the mass determination of $K^*(700)$ and by more than a factor of two and by factor of five the uncertainty on its width**
- It will further clarify debates of **its existence**, and therefore a long standing problem of the **existence of the scalar meson nonet**

Workshop on Excited Hyperons in QCD Thermodynamics at Freeze-Out (YSTAR2016) Mini-Proceedings

16th - 17th November, 2016 Thomas Jefferson National Accelerator Facility,
Newport News, VA, U.S.A.

P. Alba, M. Amaryan, V. Begun, R. Bellwied, S. Borsanyi, W. Broniowski, S. Capstick,
E. Chudakov, V. Crede, B. Dönigus, R. G. Edwards, Z. Fodor, H. Garcilazo, J. L. Goity,
M. I. Gorenstein, J. Günther, L. Guo, P. Huovinen, S. Katz, M. Mai, D. M. Manley,
V. Mantovani Sarti, E. Megías, F. Myhrer, J. Noronha-Hostler, H. Noumi, P. Parotto, A. Pasztor,
I. Portillo Vazquez, K. Rajagopal, C. Ratti, J. Ritman, E. Ruiz Arriola, L. L. Salcedo,
I. Strakovsky, J. Stroth, A. H. Tang, Y. Tsuchikawa, A. Valcarce, J. Vijande, and V. Yu. Vovchenko

Editors: M. Amaryan, E. Chudakov, K. Rajagopal, C. Ratti, J. Ritman, and I. Strakovsky

Abstract

This Workshop brought top experts, researchers, postdocs, and students from high-energy heavy-ion interactions, lattice QCD and hadronic physics communities together. YSTAR2016 discussed the impact of "missing" hyperon resonances on QCD thermodynamics, on freeze-out in heavy ion collisions, on the evolution of early universe, and on the spectroscopy of strange particles. Recent studies that compared lattice QCD predictions of thermodynamic properties of quark-gluon plasma at freeze-out with calculations based on statistical hadron resonance gas models as well as experimentally measured ratios between yields of different hadron species in heavy ion collisions provide indirect evidence for the presence of "missing" resonances in all of these contexts. The aim of the YSTAR2016 Workshop was to sharpen these comparisons and advance our understanding of the formation of strange hadrons from quarks and gluons microseconds after the Big Bang and in today's experiments at LHC and RHIC as well as at future facilities like FAIR, J-PARC and CL at JLab.

It was concluded that the new initiative to create a secondary beam of neutral kaons at JLab will make a bridge between the hadron spectroscopy, heavy-ion experiments and lattice QCD studies addressing some major issues related to thermodynamics of the early universe and cosmology in general.

Formation of Visible Matter during the Freeze-Out of the Universe after the Big Bang

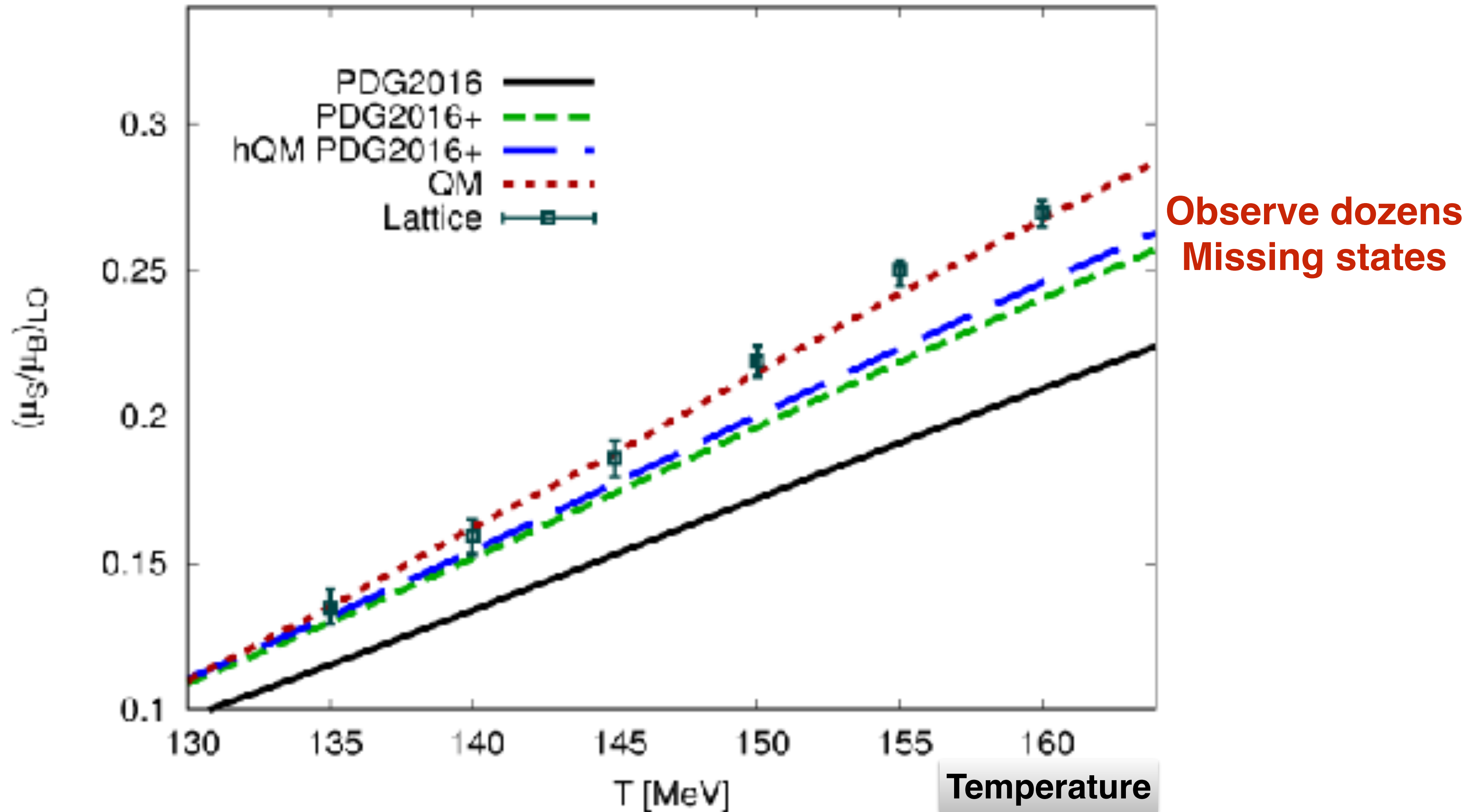

Formation of Visible Matter during the Freeze-Out of the Universe after the Big Bang

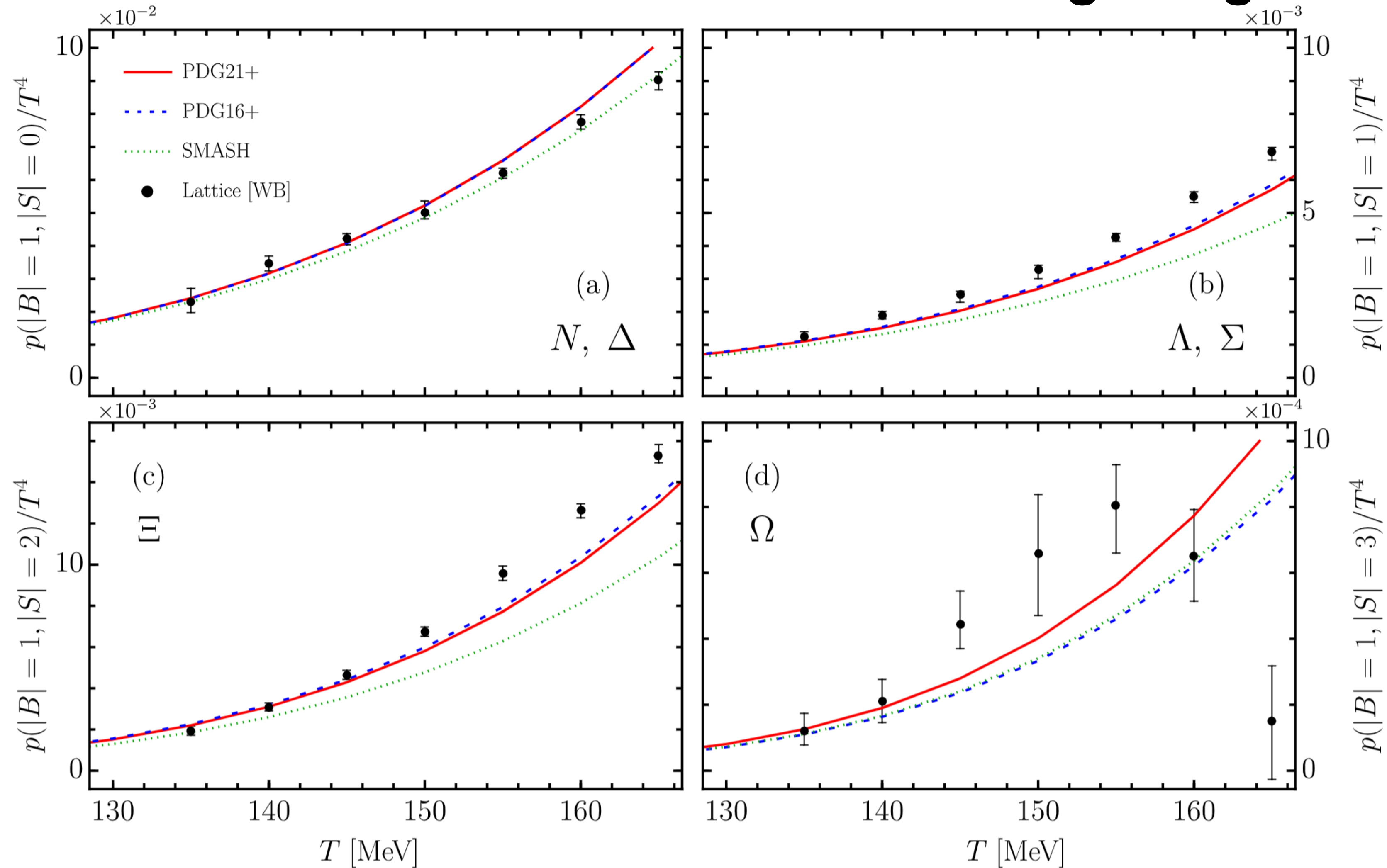

Private Communication:

Salinas San Martin, Karthein, Hammelmann, Hirayama, Parotto, Elfner, Noronha-Hostler, Ratti, to appear soon : <https://arxiv.org/abs/2309.01737>

**Needs to Observe dozens
Of Missing states**

Missing K^* 's

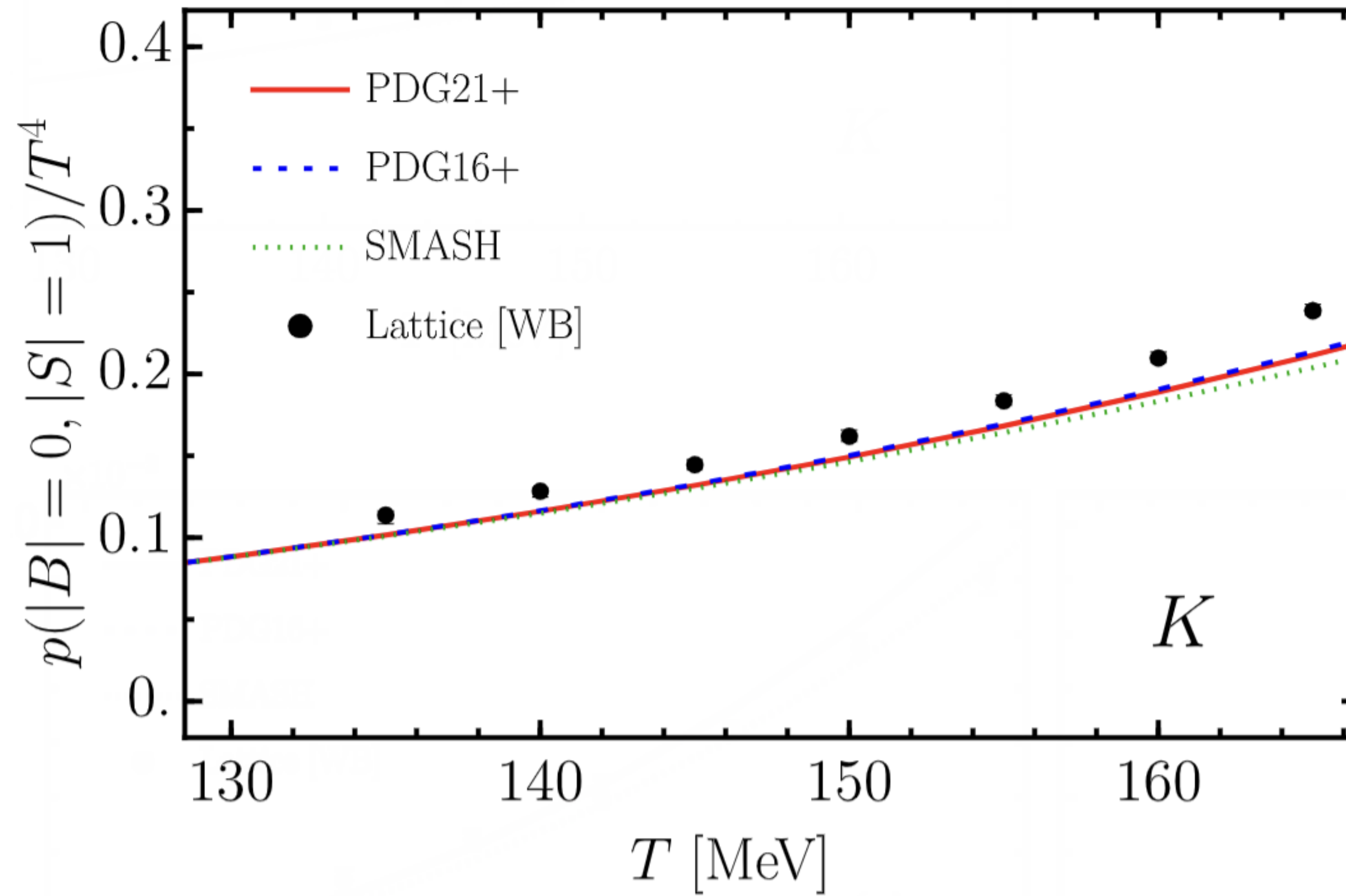

HISTORY OF THE UNIVERSE

1 μ s

KLF

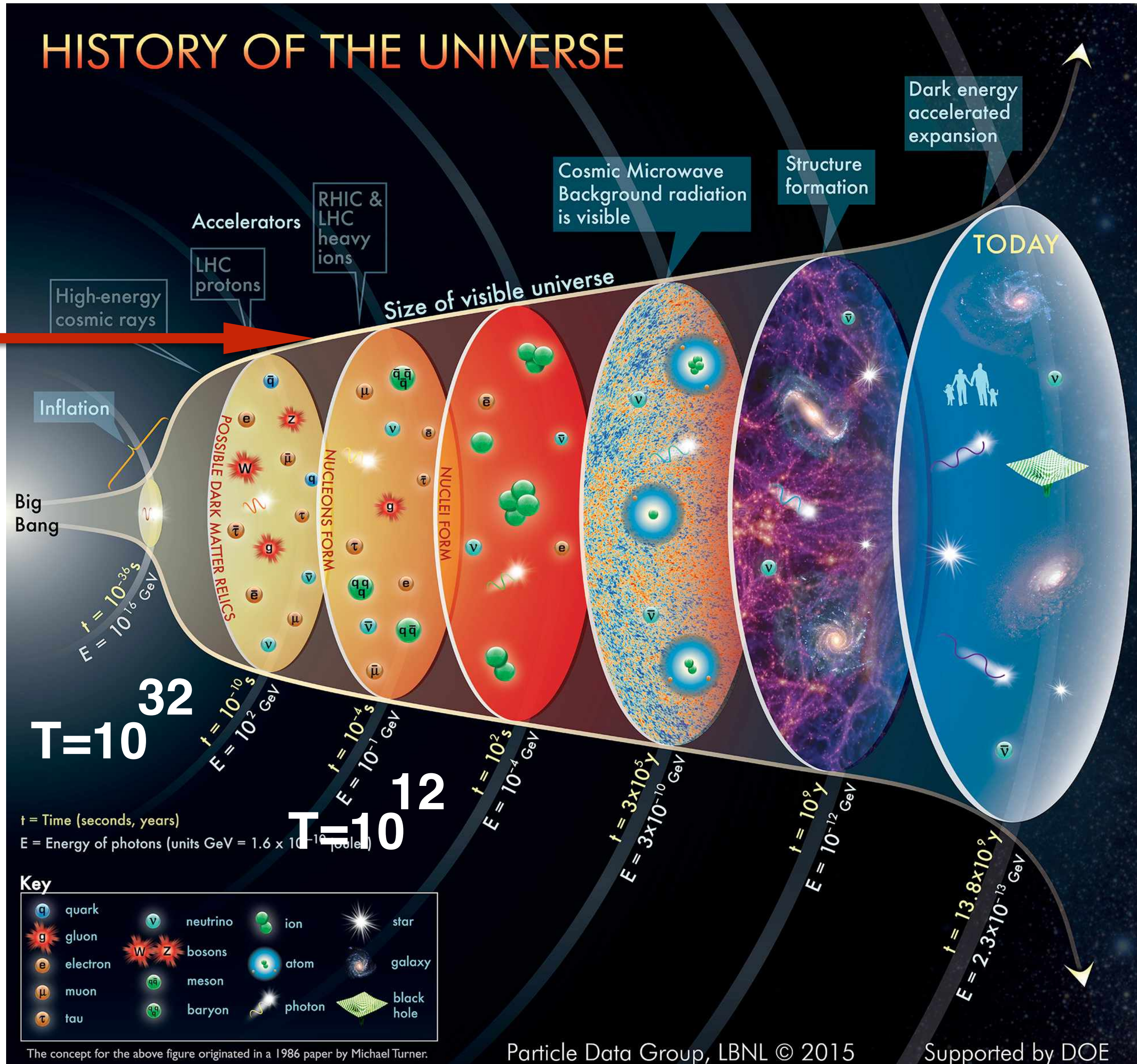

What else?

Pentaquarks

Eur. Phys. J. Plus (2022)
137:684, M.Amaryan
History and geography of
light pentaquark searches:
challenges and pitfalls

Modern Physics Letters A
(2024) 2450063
D.Jido, S.Hirama, I.Strakovsky,
M.A.

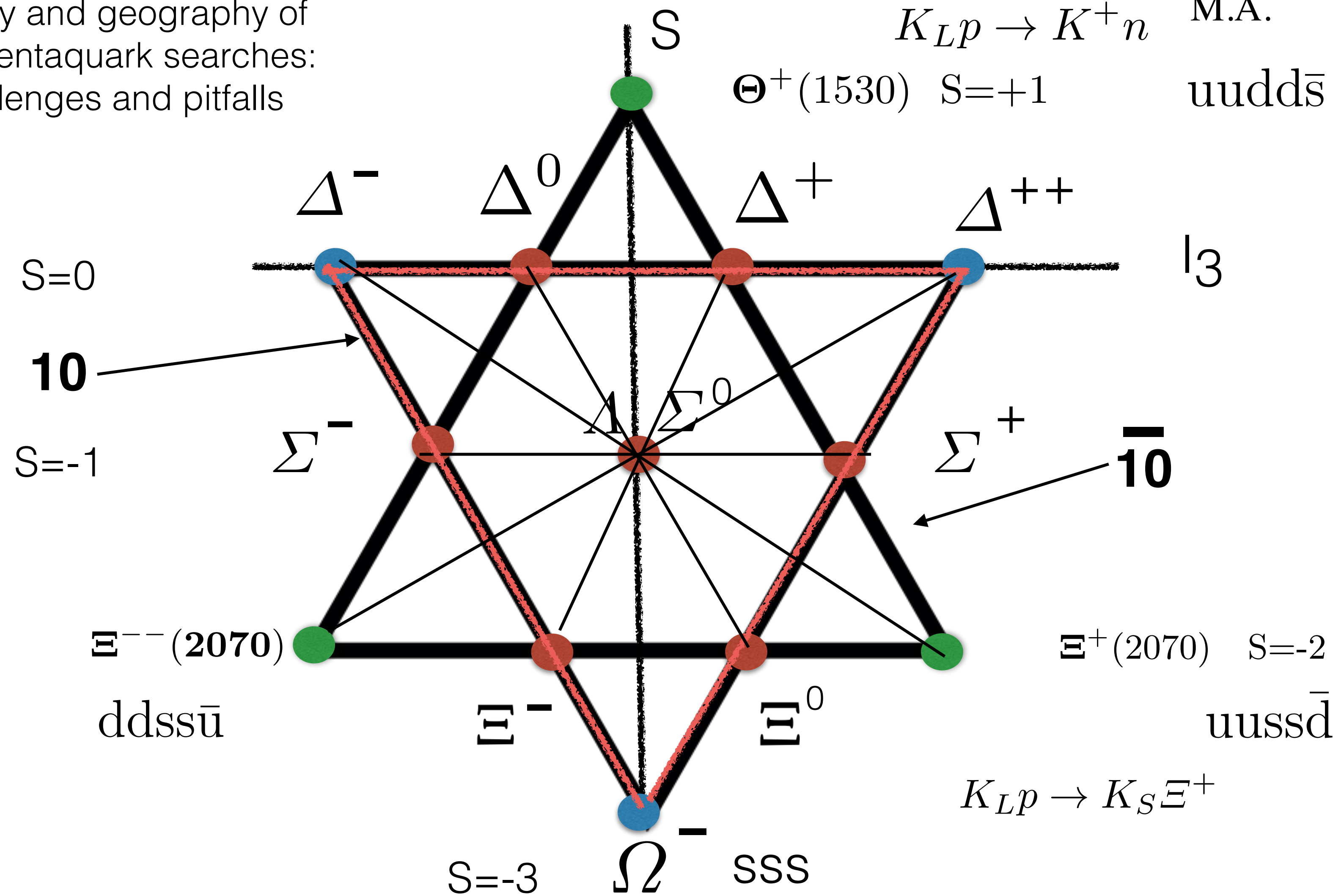

D. Diakonov, V. Petrov and M. V. Polyakov, Z. Phys. A **359**, 305 (1997).

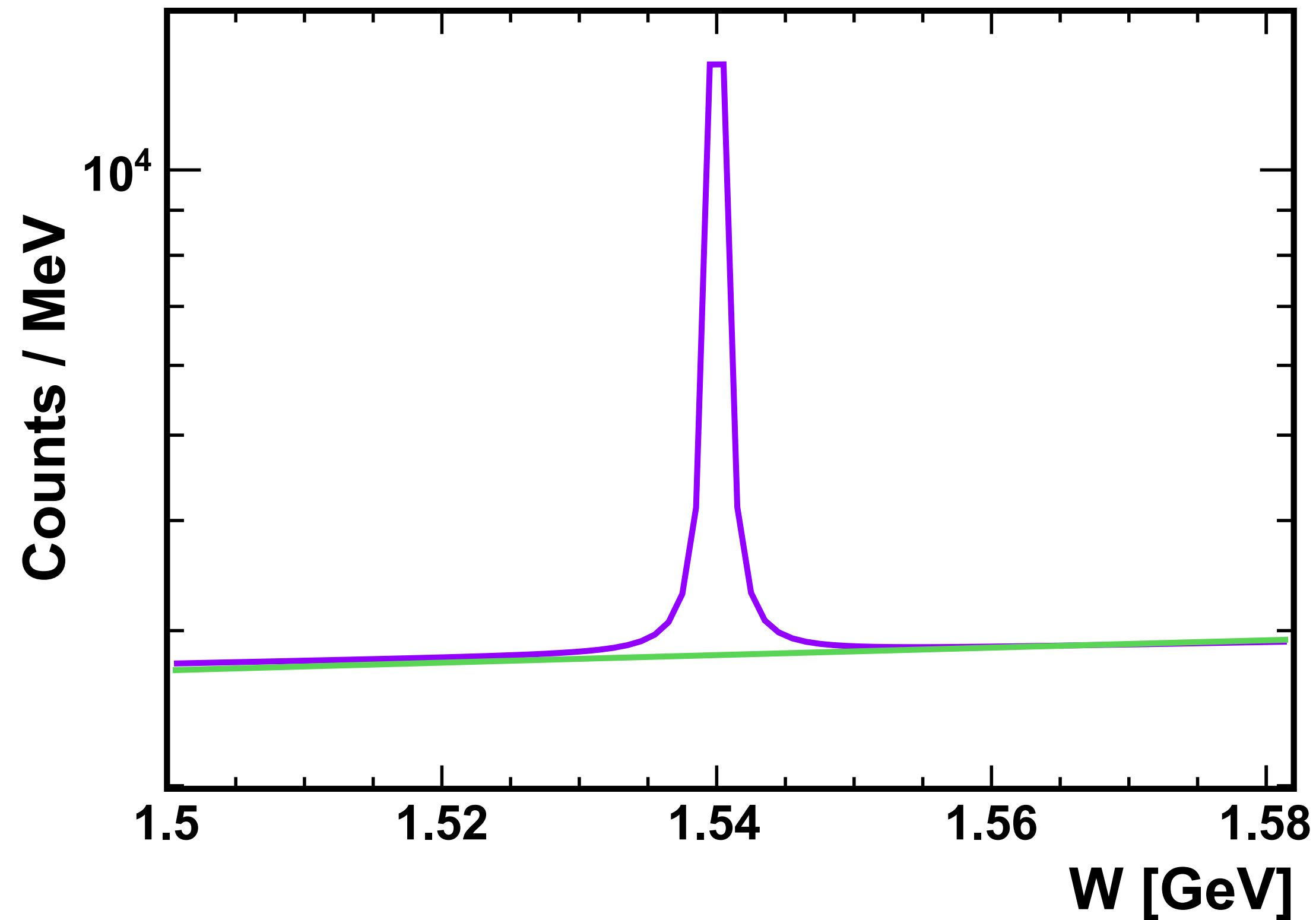

Modern Physics Letters A
 (2024) 2450063
 D.Jido, S.Hirama, I.Strakovsky,
 M.A.

Fig. 5. (Color online) Expected number of events in reaction $K_L p \rightarrow K^+ n$ as a function of W . The background for $K_L p \rightarrow K^+ N$ (solid green curve) was simulated based on the prediction of the model.¹⁹ The number of events in the peak for 100 days of running (purple solid curve) is estimated to be about 10,000 events (see text for details).

Is everything feasible from hardware point of view?

Next few slides will answer this question.

Reminder:

Hall-D beamline and GlueX Setup

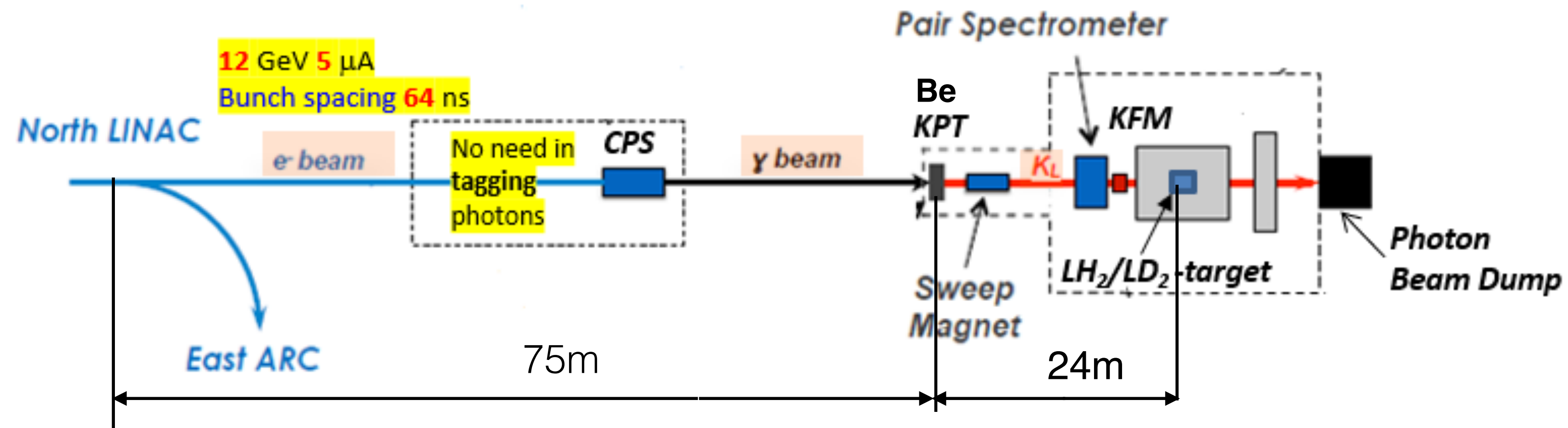

<https://arxiv.org/pdf/2008.08215.pdf>

Compact Photon Source

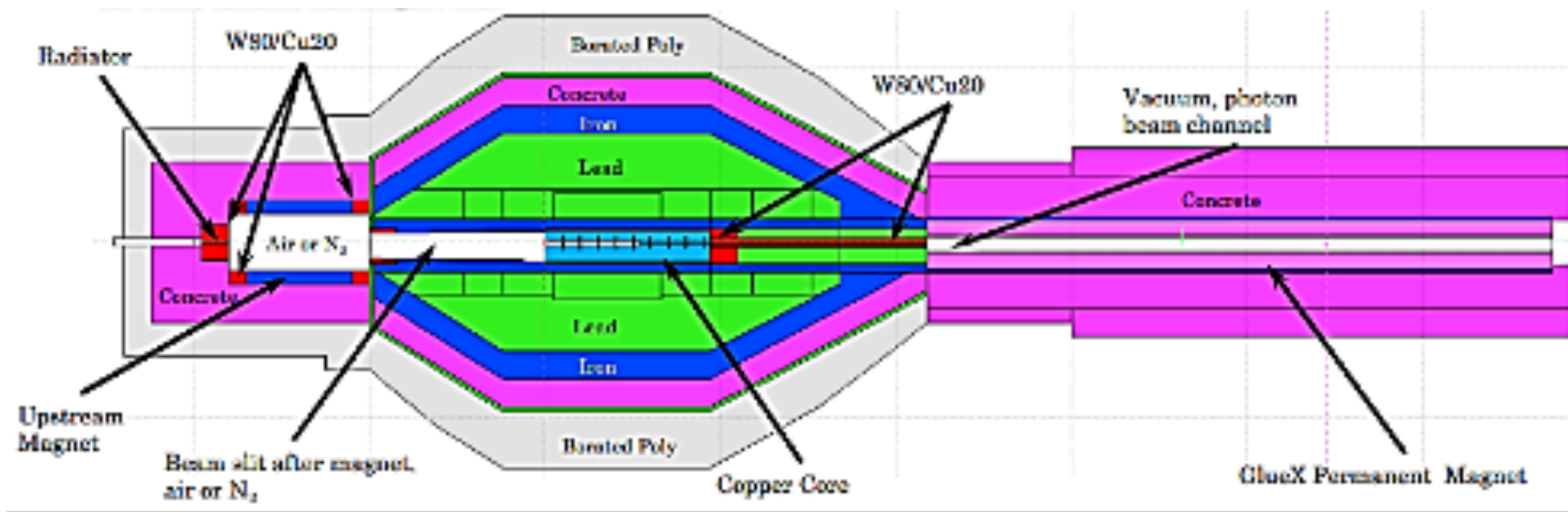

Be Target Assembly: Conceptual Design

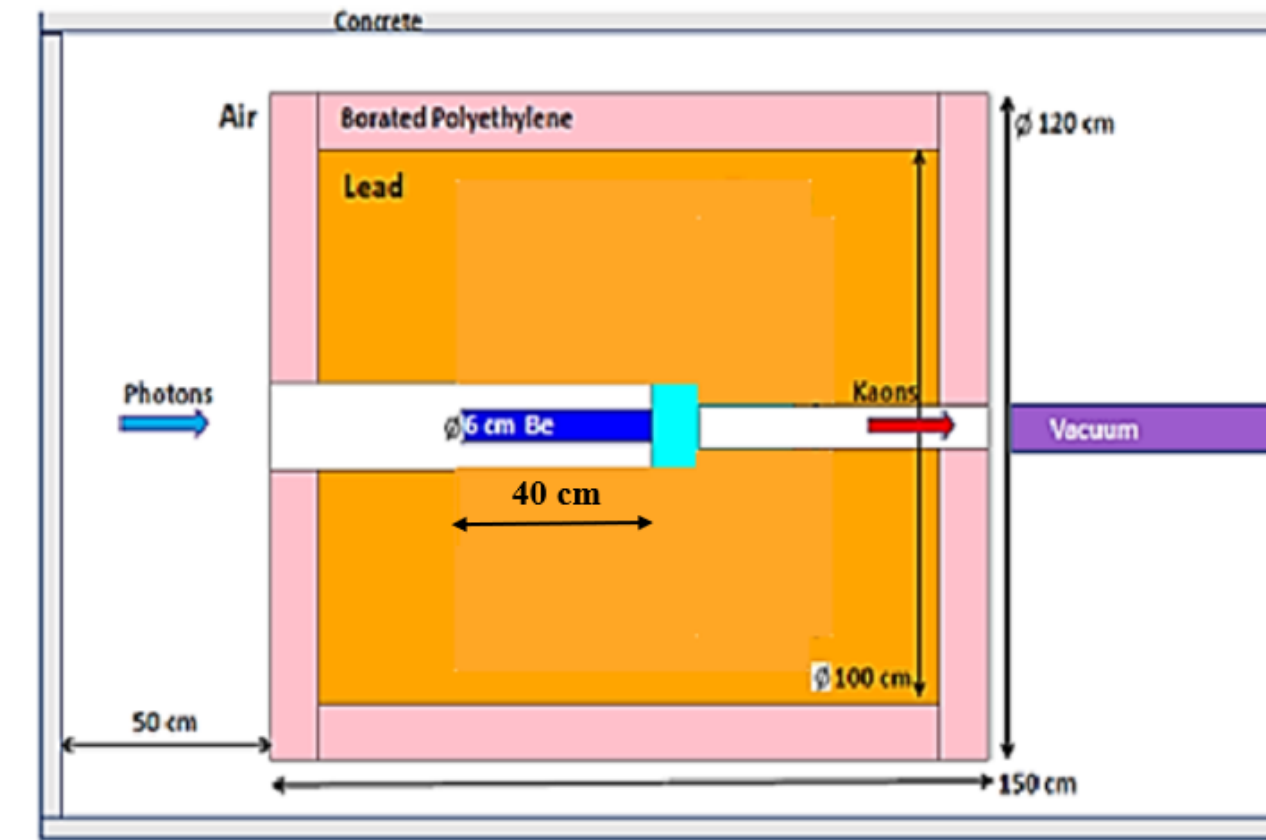

- Meets RadCon Radiation Requirements
- Conceptual Design Endorsed by Hall-D Engineering Staff

arXiv: 2002.04442

Flux Monitor

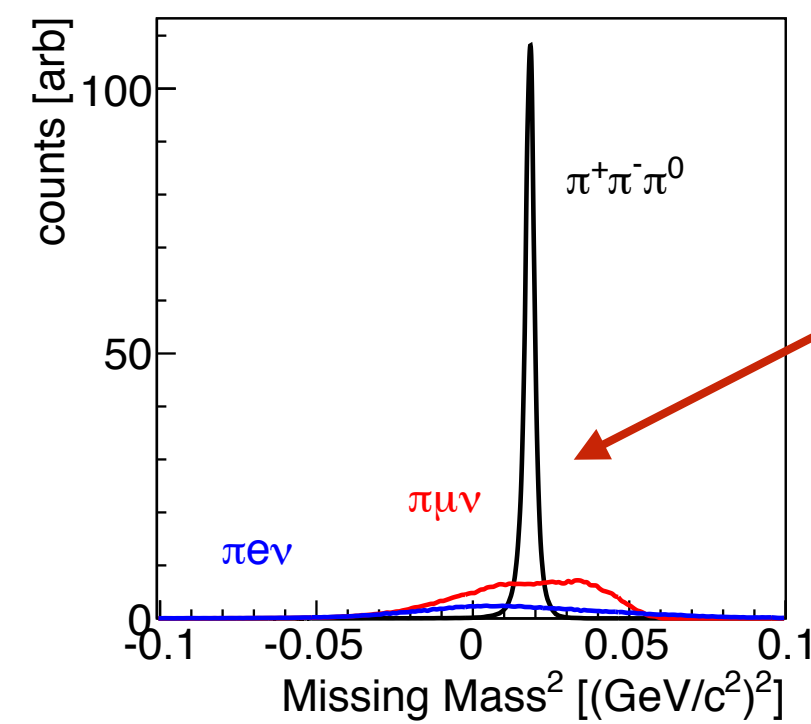
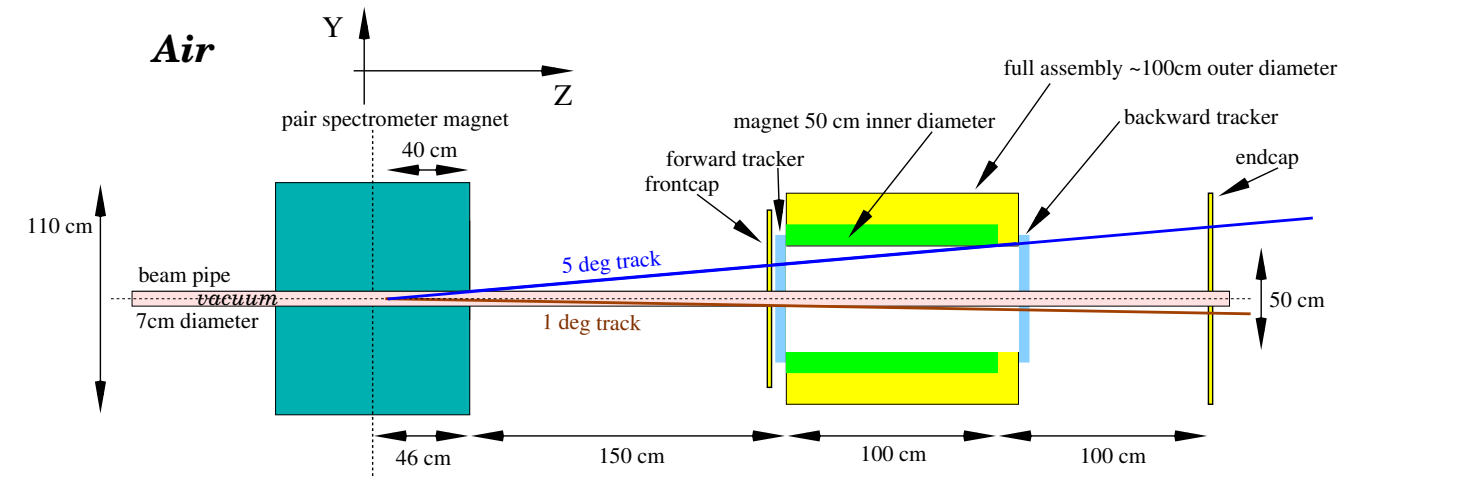

Reconstructed K_L mass

Flux measurement stat. err. <1%

Estimated conservative syst. err. ~5%

LH₂/LD₂ Cryogenic Target for Neutral Kaon Beam at Hall D

The GlueX liquid hydrogen target.

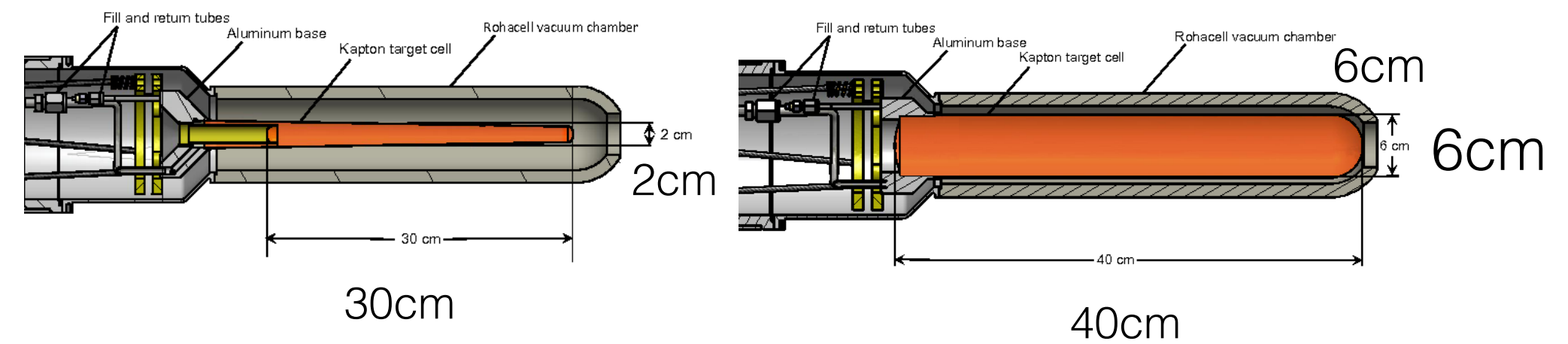

Current

Proposed & Feasible

- Longer and thicker target is needed to enhance production rate
- Conceptual design has been endorsed by the JLAB target group

Timeline of Design, Construction and Installation

Scheduling Outlook

13

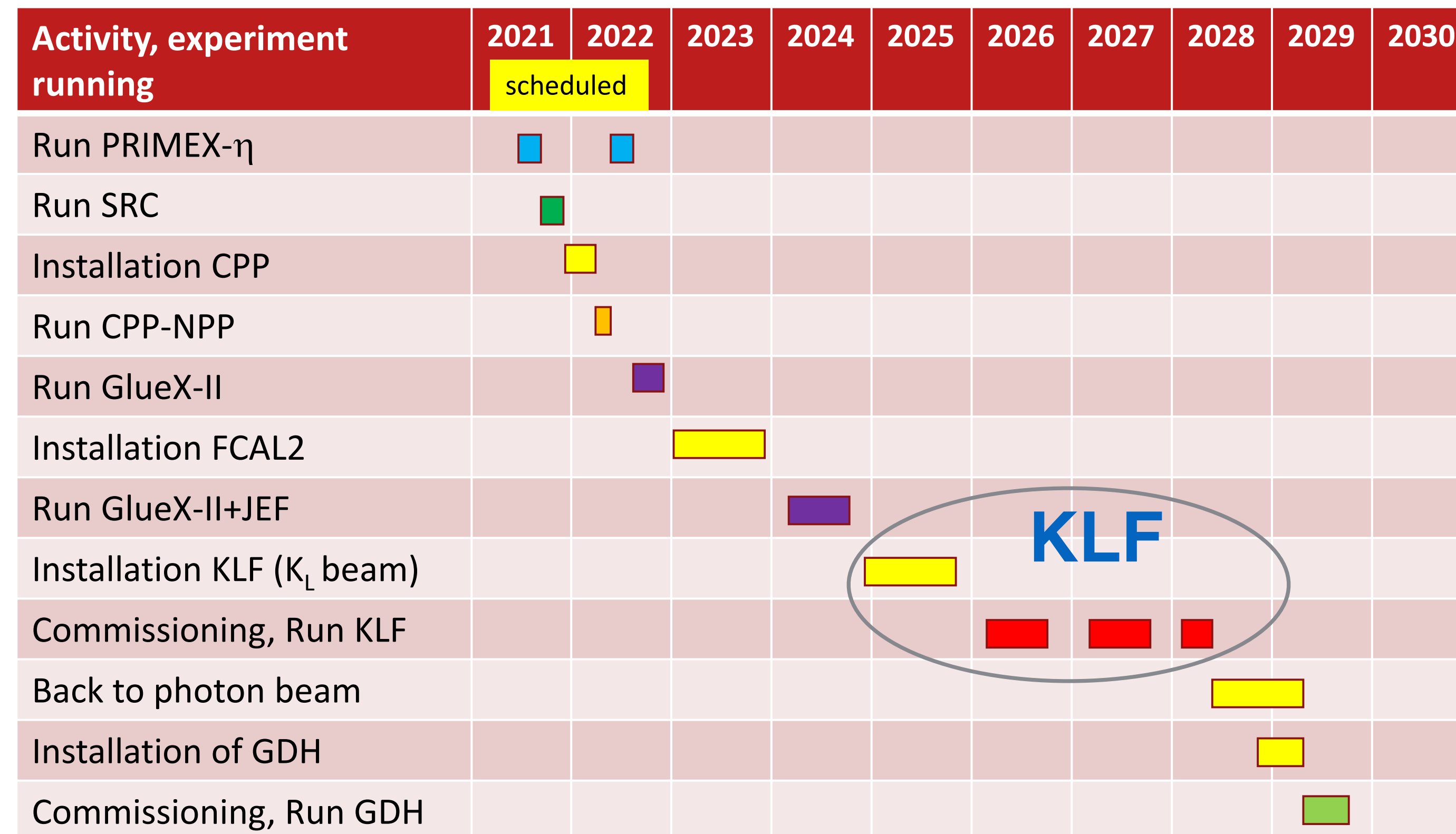

- Assumed 25 weeks/year for Hall D running
- Assumed timely budgeting for KLF and GDH

- Assumed timely construction of JEF, KLF, GDH

13

Jefferson Lab

E. Chudakov
GlueX Coll. Meeting, Oct. 2021

The Facility is Flexible and can be switched back to photon beam

PHYSICS WITH NEUTRAL KAON BEAM AT JLAB
KL2016

FEBRUARY 1-3, 2016
JEFFERSON LAB
NEWPORT NEWS, VIRGINIA

SCOPE

The Workshop is following Lof12-15-001 "Physics Opportunities with Secondary KL beam at JLab" and will be dedicated to the physics of hyperons produced by the kaon beam on unpolarized and polarized targets with GlueX set up in Hall D. The emphasis will be on the hyperon spectroscopy. Such studies could contribute to the existing scientific program on hadron spectroscopy at Jefferson Lab.

The Workshop will also aim at boosting the international collaboration, in particular between the US and EU research institutions and universities.

The Workshop would help to address the comments made by the PAC43, and to prepare the full proposal for the next PAC44.

ORGANIZING COMMITTEE

Moskov Amaryan, ODU, chair
Eugene Chudakov, JLab
Curtis Meyer, CMU
Michael Pennington, JLab
James Ritman, Ruhr-Uni-Bochum & IKP Jülich
Igor Strakovsky, GWU

www.jlab.org/conferences/kl2016

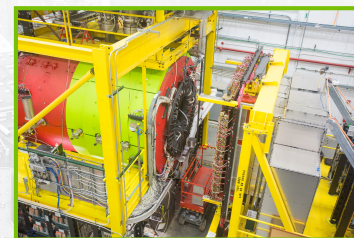
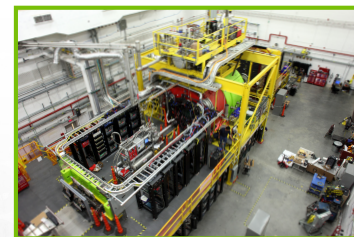

YSTAR
Excited Hyperons in QCD
Thermodynamics at Freeze-Out **2016**

NOVEMBER 16 - 17, 2016

Jefferson Lab
Newport News, Virginia

A workshop to discuss the influence of possible "missing" hyperon resonances (JLab KLF Project) on QCD thermodynamics, on freeze-out in heavy ion collisions and in the early universe, and in spectroscopy. Recent studies that compare lattice QCD calculations of thermodynamic calculations, statistical hadron resonance gas models, and ratios between measured yields of different hadron species in heavy ion collisions provide indirect evidence for the presence of "missing" resonances in all of these contexts. The aim of the workshop is to sharpen these comparisons, advance our understanding of the formation of baryons from quarks and gluons microseconds after the Big Bang and in today's experiments, and to connect these developments to experimental searches for direct, spectroscopic, evidence for these resonances. This Workshop is a successor to the recent KL2016 Workshop

ORGANIZING COMMITTEE

Moskov Amaryan – Chair, ODU
Eugene Chudakov, JLab
Kishore Rajagopal, MIT
Claudia Ratti, University of Houston
James Ritman, Ruhr U. Bochum & IKP Jülich
Igor Strakovsky, GWU

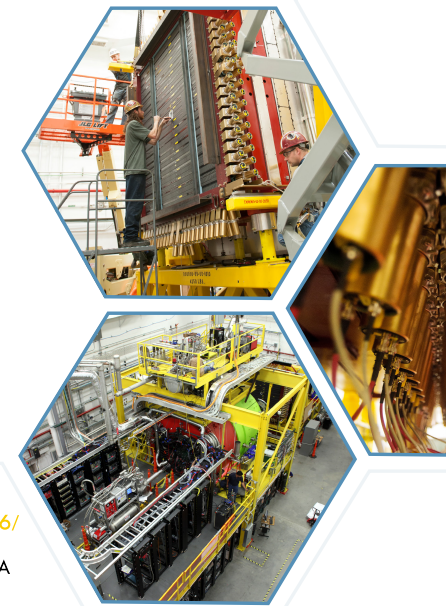

www.jlab.org/conferences/ystar2016/



HIPS 2017
New Opportunities with High-Intensity Photon Sources

February 6-7, 2017
Catholic University of America
Washington, DC U.S.A.

This workshop aims at producing an optimized photon source concept with potential increase of scientific output at Jefferson Lab, and at refining the science for hadron physics experiments benefiting from such a high-intensity photon source. The workshop is dedicated to bringing together the communities directly using such sources for photo-production experiments, or for conversion into K_s beams. The combination of high precision calorimetry and high intensity photon sources can provide greatly enhanced scientific benefit to (deep) exclusive processes like wide-angle and time-like Compton scattering. Potential prospects of such a high-intensity source with modern polarized targets will also be discussed. The availability of K_s beams would open new avenues for hadron spectroscopy, for example for the investigations of "missing" hyperon resonances, with potential impact on QCD thermodynamics and on freeze-out both in heavy ion collisions and the early universe.

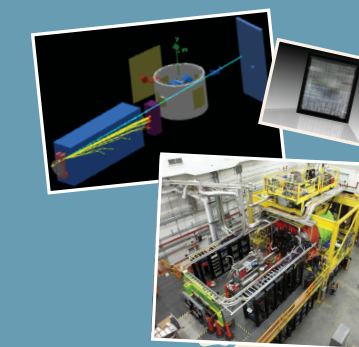

Organizing Committee:
Tanja Horn – CIA
Cynthia Keppel – JLab
Carlos Munoz-Camacho – IPNO
Igor Strakovsky – GWU



π-K Interactions
Workshop

February 14-15, 2018
Jefferson Lab • Newport News, VA

The πK scattering enables direct investigations of scalar and vector K* states, including the not yet established S-wave K(800) state. These studies are also needed to get precise values of vector and scalar form factors: to independently extract CKM matrix element V_{us} and to test the Standard Model unitarity relation in the first row of CKM matrix, to study CP violation from the Dalitz plot analysis of open charm D meson decays and in a charmless decays of B mesons in Kππ final states. Significant progress is made lately in Lattice QCD, in the phenomenology and in the Chiral Perturbation Theory to describe different aspects of πK scattering. The main source of experimental data is based on experiments performed in SLAC almost five decades ago at 1970-80s. The recently proposed KL Facility incorporating the GlueX spectrometer at JLab will be able to improve the πK scattering database by about three orders of magnitude in statistics. The workshop will discuss the necessity for and the impact of the future high statistics data obtained at JLab on πK scattering.

ORGANIZING COMMITTEE

Moskov Amaryan, ODU (Chair)
Ulf-G. Meißner, U. Bonn/FZ Jülich
Curtis Meyer, CMU
James Ritman, Ruhr-Uni-Bochum/FZ Jülich
Igor Strakovsky, GWU

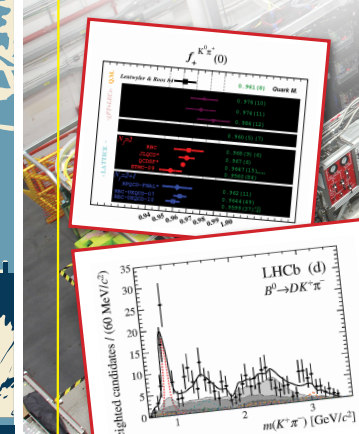
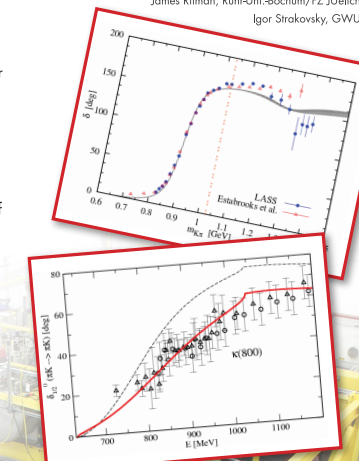

<https://www.jlab.org/conferences/pki2018/>

KL2016

[60 people from 10 countries, 30 talks] <https://www.jlab.org/conferences/kl2016/>

OC: M. Amaryan, E. Chudakov, C. Meyer, M. Pennington, J. Ritman, & I. Strakovsky

YSTAR2016

[71 people from 11 countries, 27 talks] <https://www.jlab.org/conferences/ystar2016/>

OC: M. Amaryan, E. Chudakov, K. Rajagopal, C. Ratti, J. Ritman, & I. Strakovsky

HIPS2017

[43 people from 4 countries, 19 talks] <https://www.jlab.org/conferences/hips2017/>

OC: T. Horn, C. Keppel, C. Munoz-Camacho, & I. Strakovsky

PKI2018

[48 people from 9 countries, 27 talks] <http://www.jlab.org/conferences/pki2018/>

OC: M. Amaryan, U.-G. Meißner, C. Meyer, J. Ritman, & I. Strakovsky

In total: 222 participants & 103 talks

SUMMARY

- **-Proposed KL Facility has a unique capability to improve existing world database up to three orders of magnitude**
- **-In Hyperon spectroscopy**
PWA will allow to unravel and measure pole positions and widths of a **few dozens** of new excited states
- **-In Strange Meson Spectroscopy**
PWA will allow to measure excited K^* states
- **To accomplish physics program 200 days running is approved**
- **All components of KL Facility considered are feasible**
-With total cost of the project below 2M

At the end we would like to invite everyone to join us.

Thanks for your attention!