

*Proposal for JLab PAC46*

***Strange Hadron Spectroscopy with  
Secondary  $K_L$  Beam at GlueX***

*Moskov Amaryan*

*(For KLF Collaboration)*

**JLab Management Briefing, May 8, 2018**

# **Outline**

## ***Physics Motivation***

- *Hyperon Spectroscopy*
- *Strange Meson Spectroscopy*

## ***K<sub>L</sub> Facility at JLab***

- *Electron Beam*
- *Compact Photon Source*
- *Be Target*
- *Flux Monitor*
- *K<sub>L</sub> Beam*
- *LH<sub>2</sub>/LD<sub>2</sub> Target*

## ***Summary***

# Hyperon Spectroscopy

According *LQCD* there should be many more states including hybrids (thick bordered)

**8-states**  
\*\*\*\*  
**5-states**  
\*\*\*

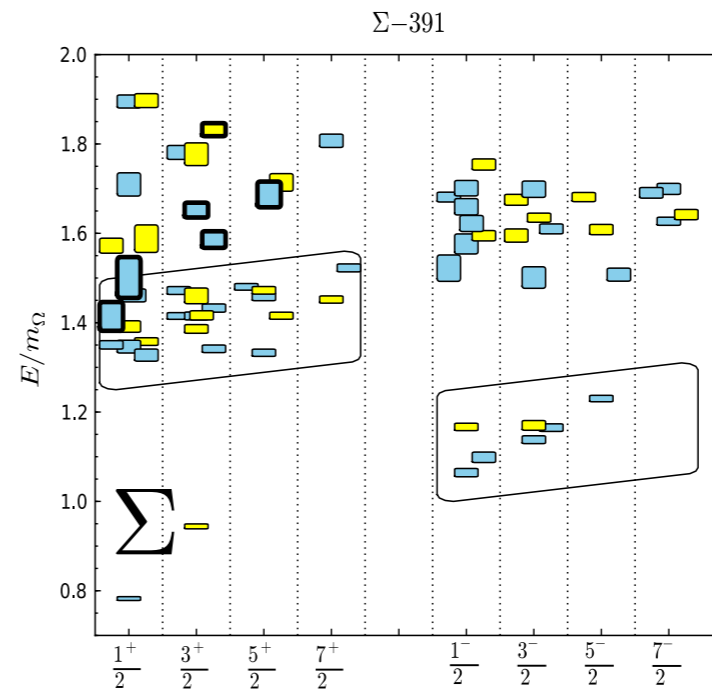
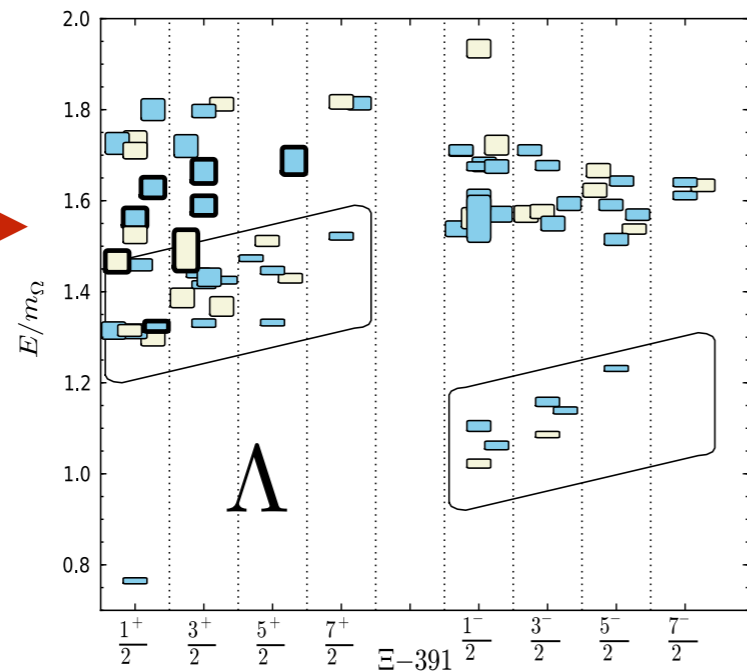

**6-states**  
\*\*\*\*  
**4-states**  
\*\*\*

**3-states**  
\*\*\*\*  
**4-states**  
\*\*\*

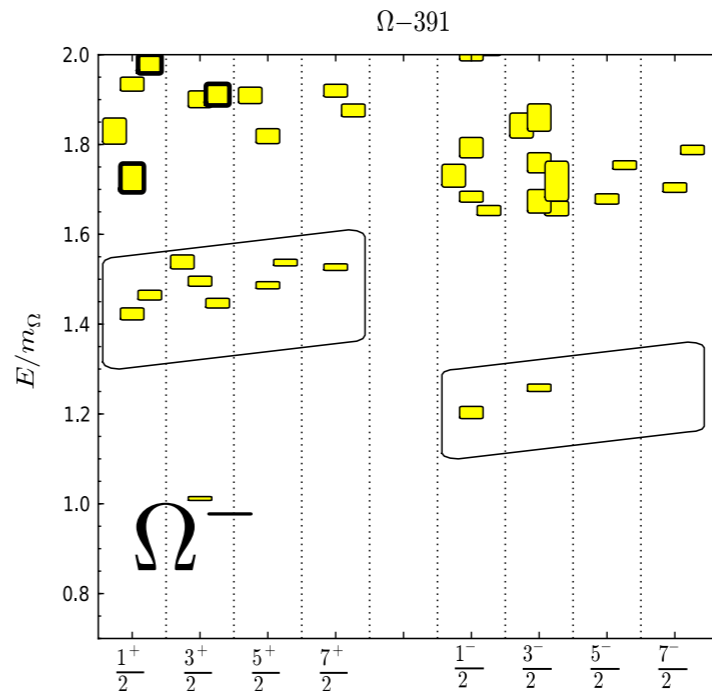
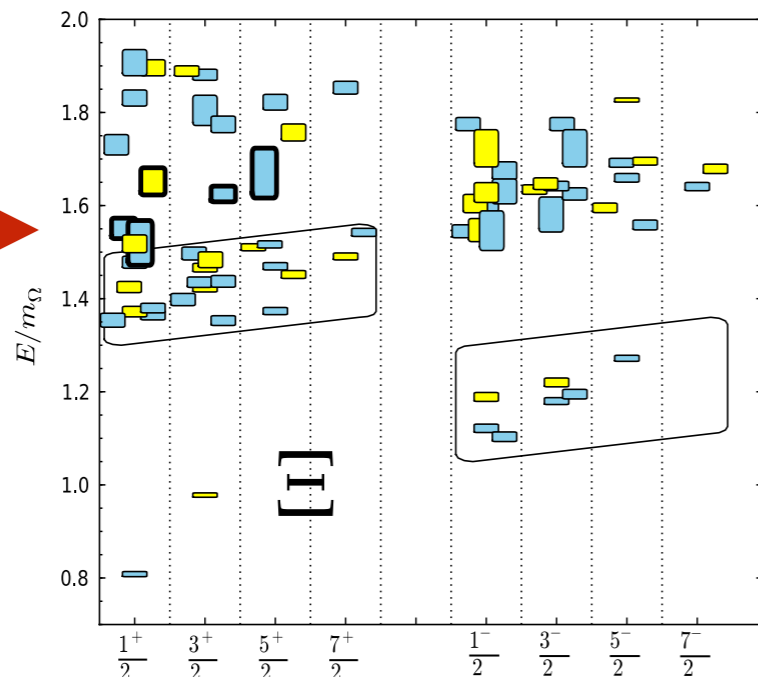

**1-state**  
\*\*\*\*  
**1-states**  
\*\*\*

Edwards, Mathur, Richards and Wallace, Phys. Rev. D 87, 054506 (2013)

# Proposed Measurements on Proton Target

existing data

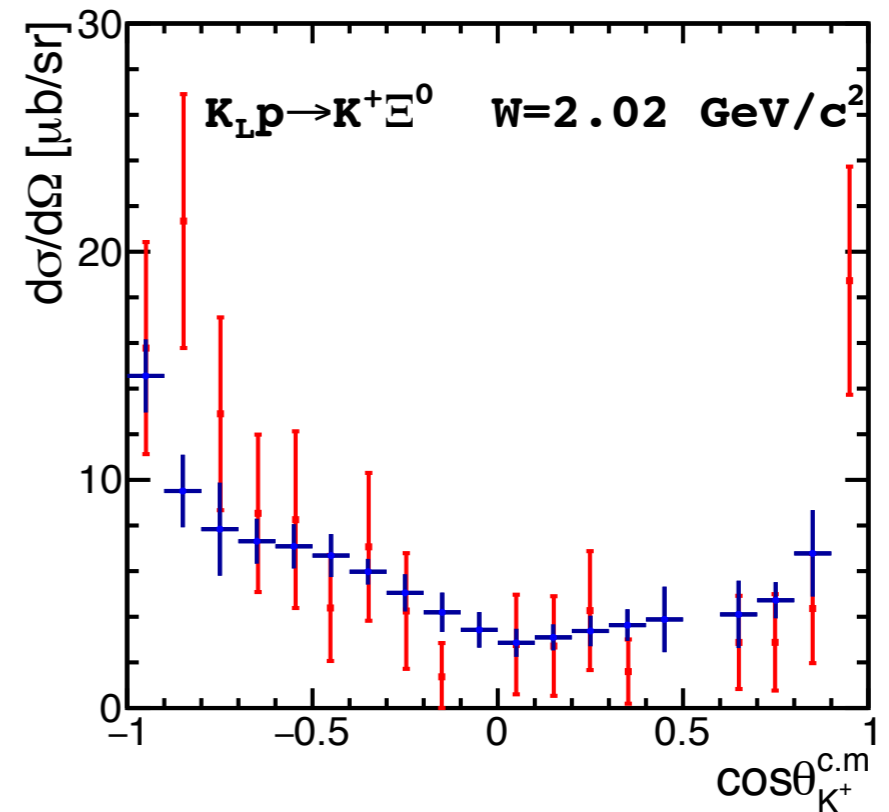
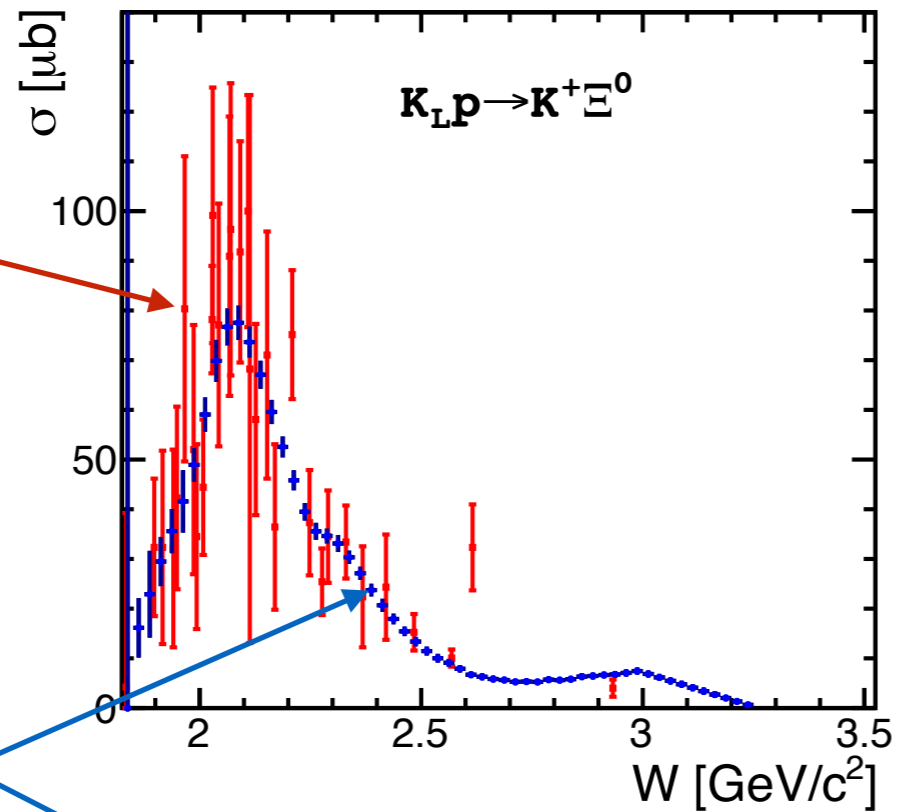

KLF 100 days

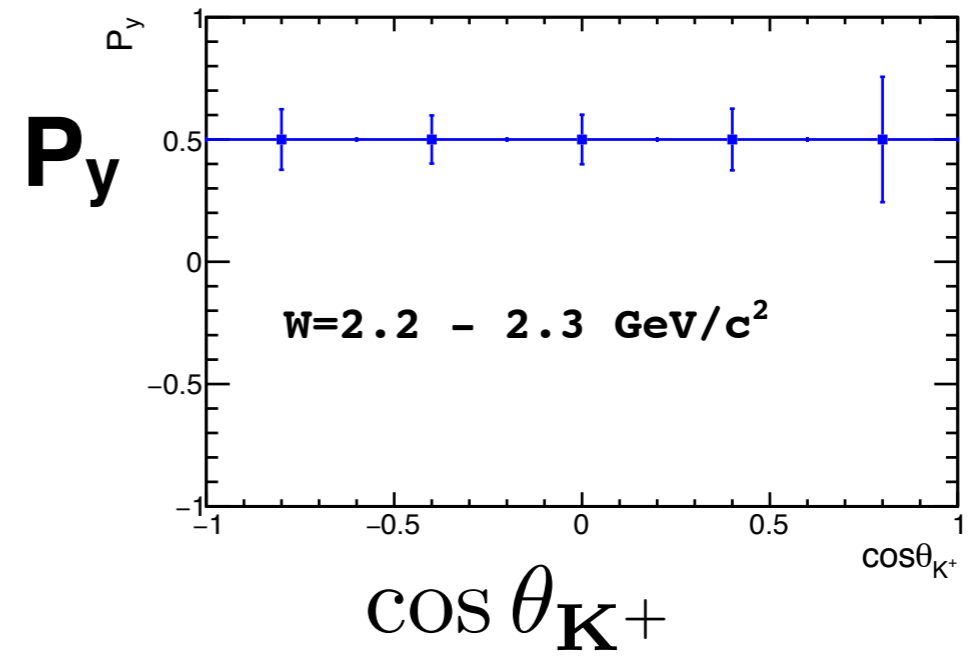
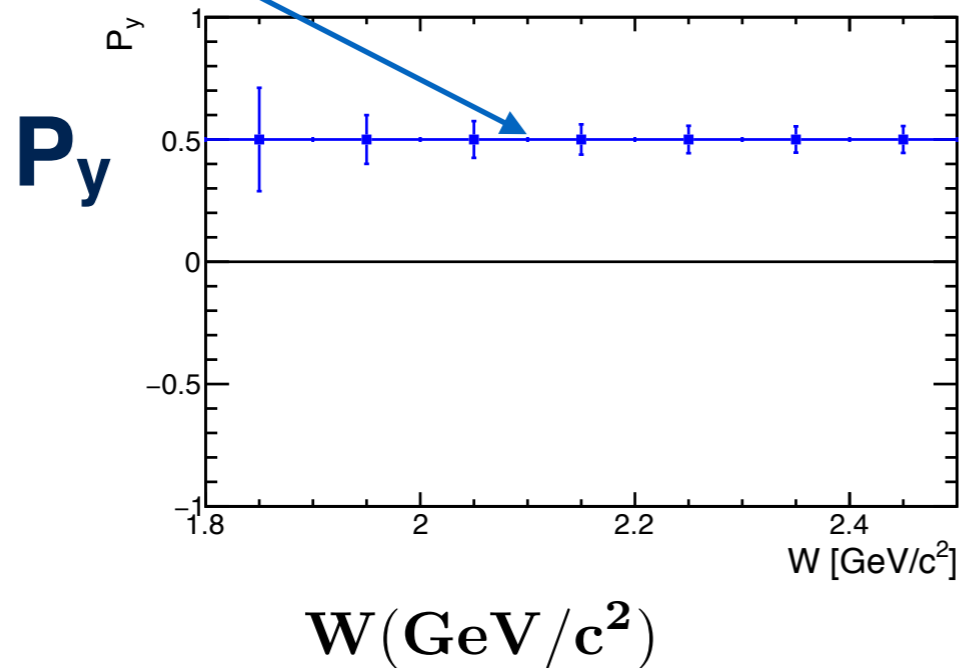

# Proposed Measurements on Neutron Target

## Sensitivity to different solutions

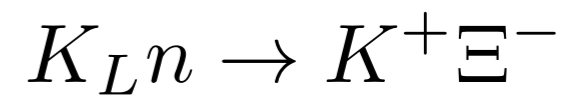
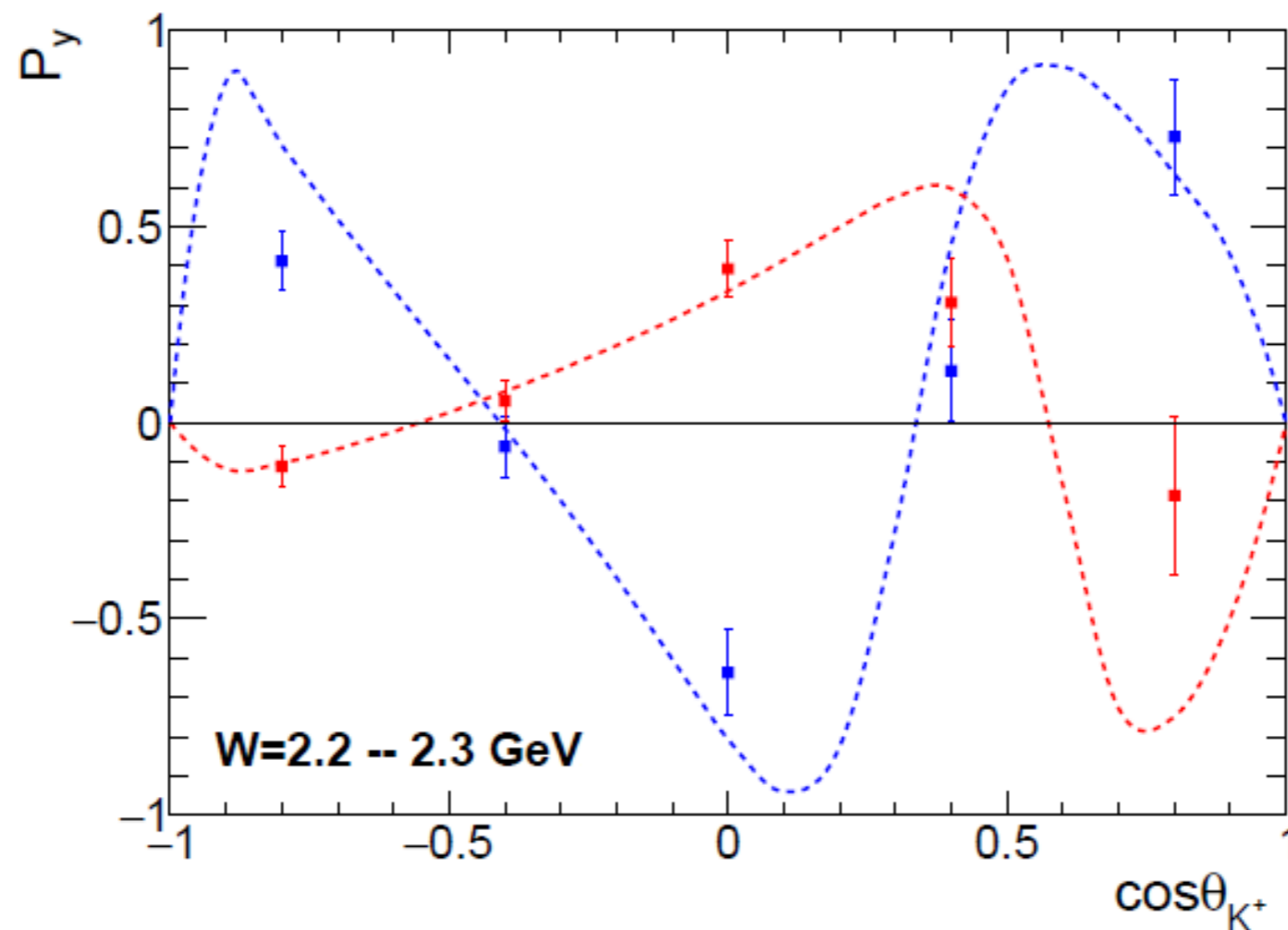

100 days on  $LD_2$  target

# ***Search for Hyperon Resonances with PWA***

**For Scattering experiments on both proton & neutron targets we need to determine:**

- differential cross sections &**
- self polarization of strange hyperons**
- perform coupled-channel PWA**
- look for poles in complex energy plane  
(not naïve bump hunting)**
- identify  $\Lambda^*$ ,  $\Sigma^*$ ,  $\Xi^*$  &  $\Omega^*$  up to 2400 MeV**

**As kaon nucleon scattering data are very poor**

**we use pion nucleon scattering data with statistics generated according to expected KLF data for 20(100) days to show PWA sensitivity to obtain results close to the best fit**

# Using $\pi p$ Scattering

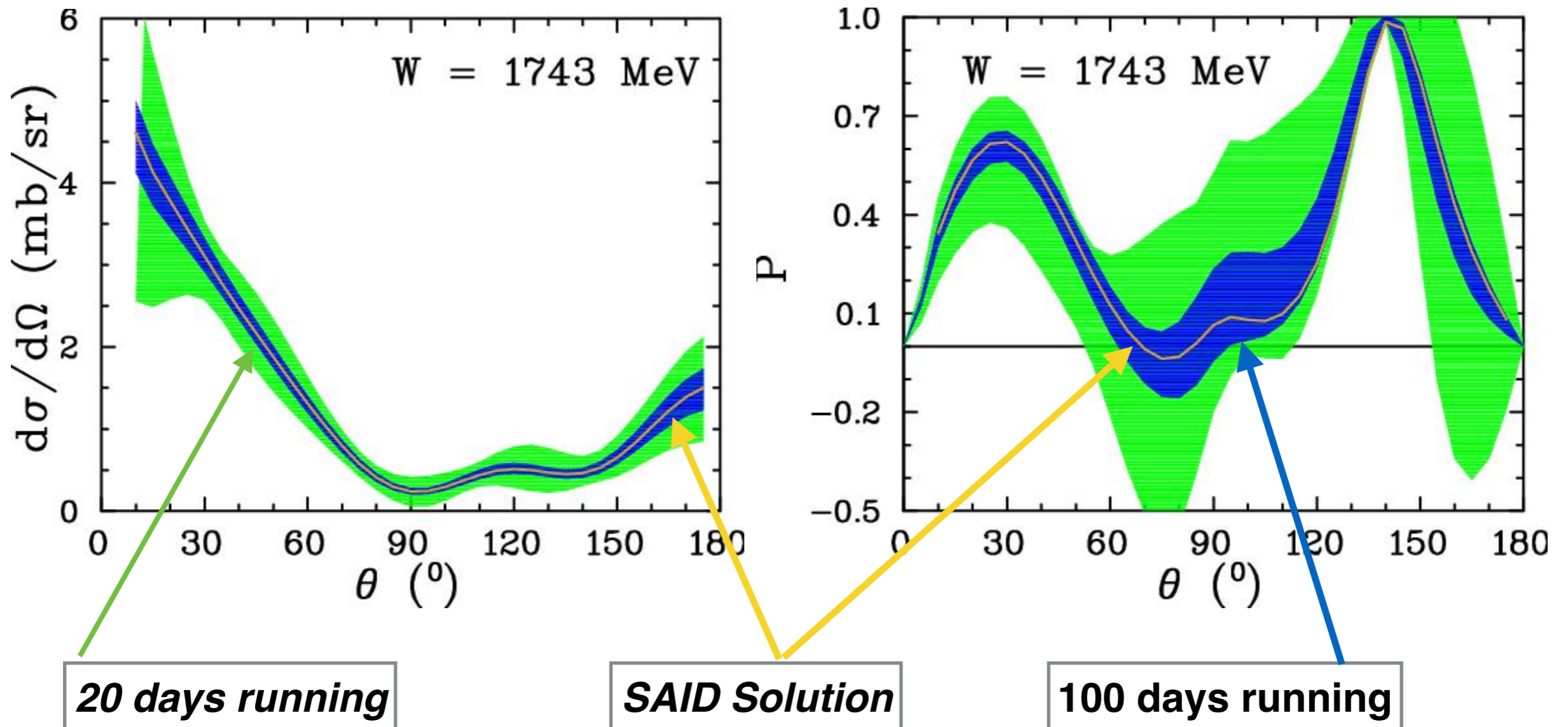

Statistics was generated according to KLF for

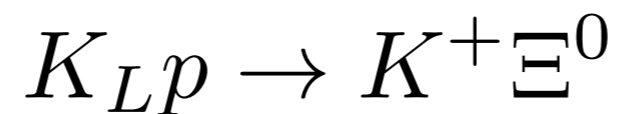

**Obviously:** we need **at least 100 days** to get unique solution

# Strange Meson Spectroscopy

## $K\pi$ Scattering

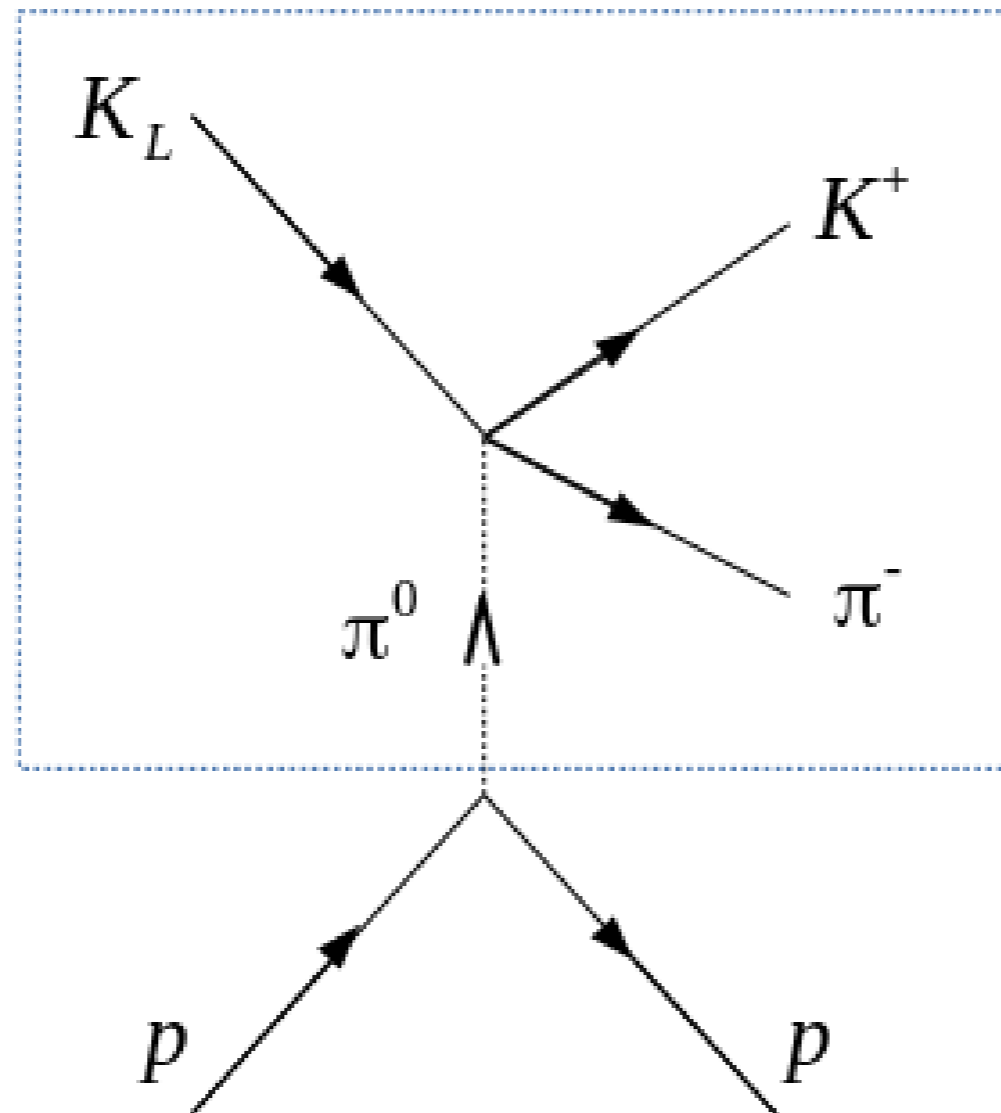



# Proposed Measurements

SLAC

$$K^- \pi^+ \rightarrow K^- \pi^+$$

Belle

$$\tau \rightarrow K \pi \nu_\tau$$

KLF

$$K_L \pi^0 \rightarrow K^+ \pi^-$$

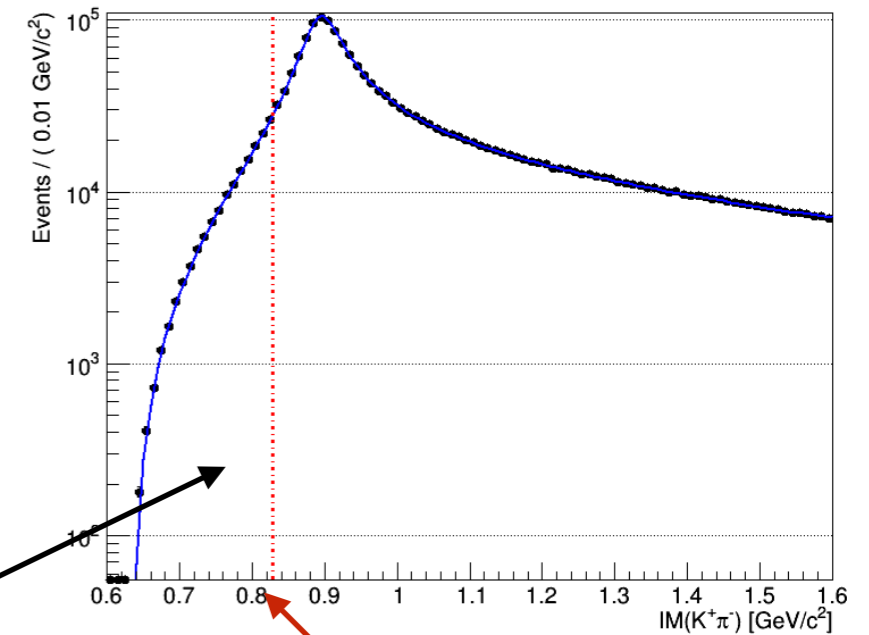
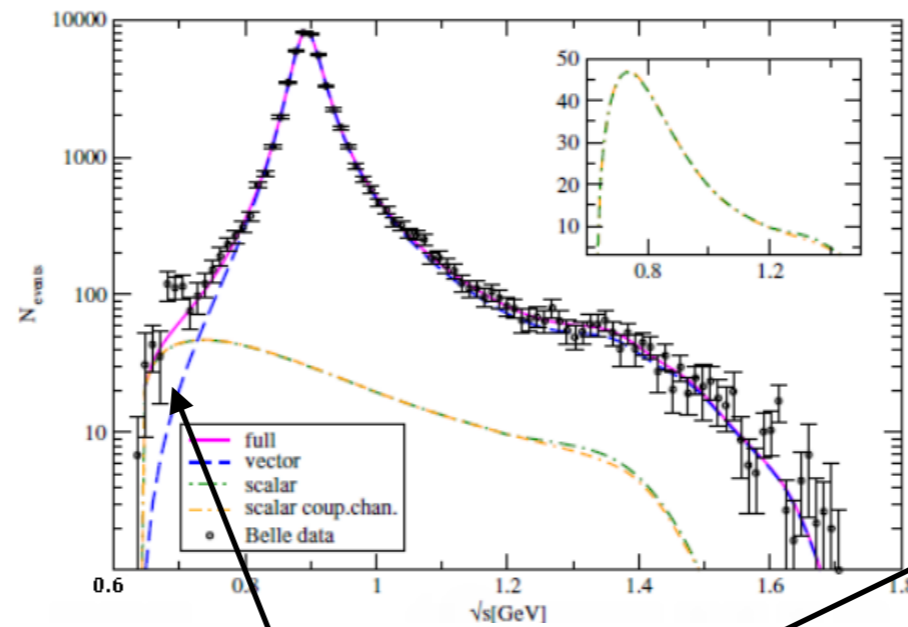
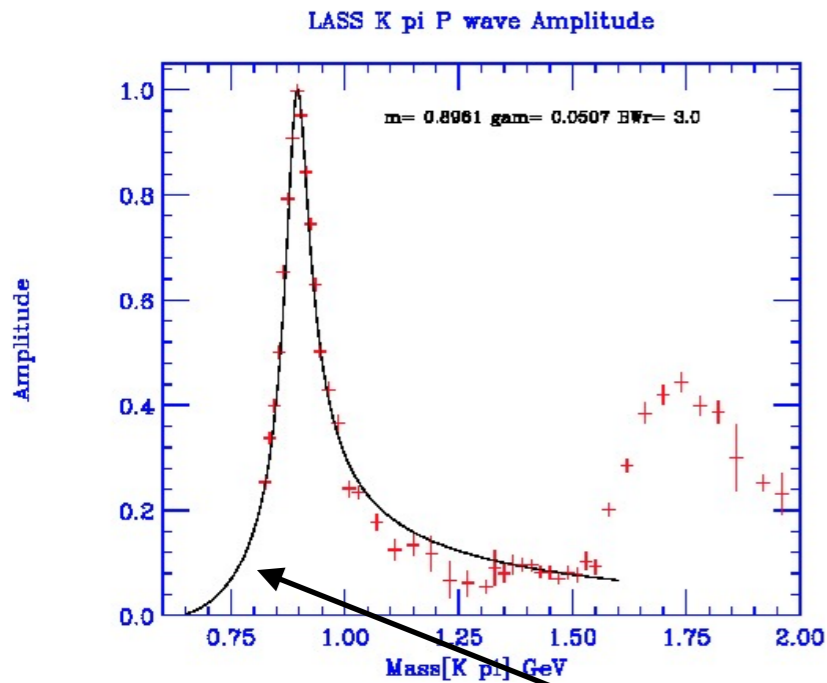

region of  $\mathcal{K}(800)$

SLAC Lower limit

# Proposed Measurement

I=1/2 S-Wave

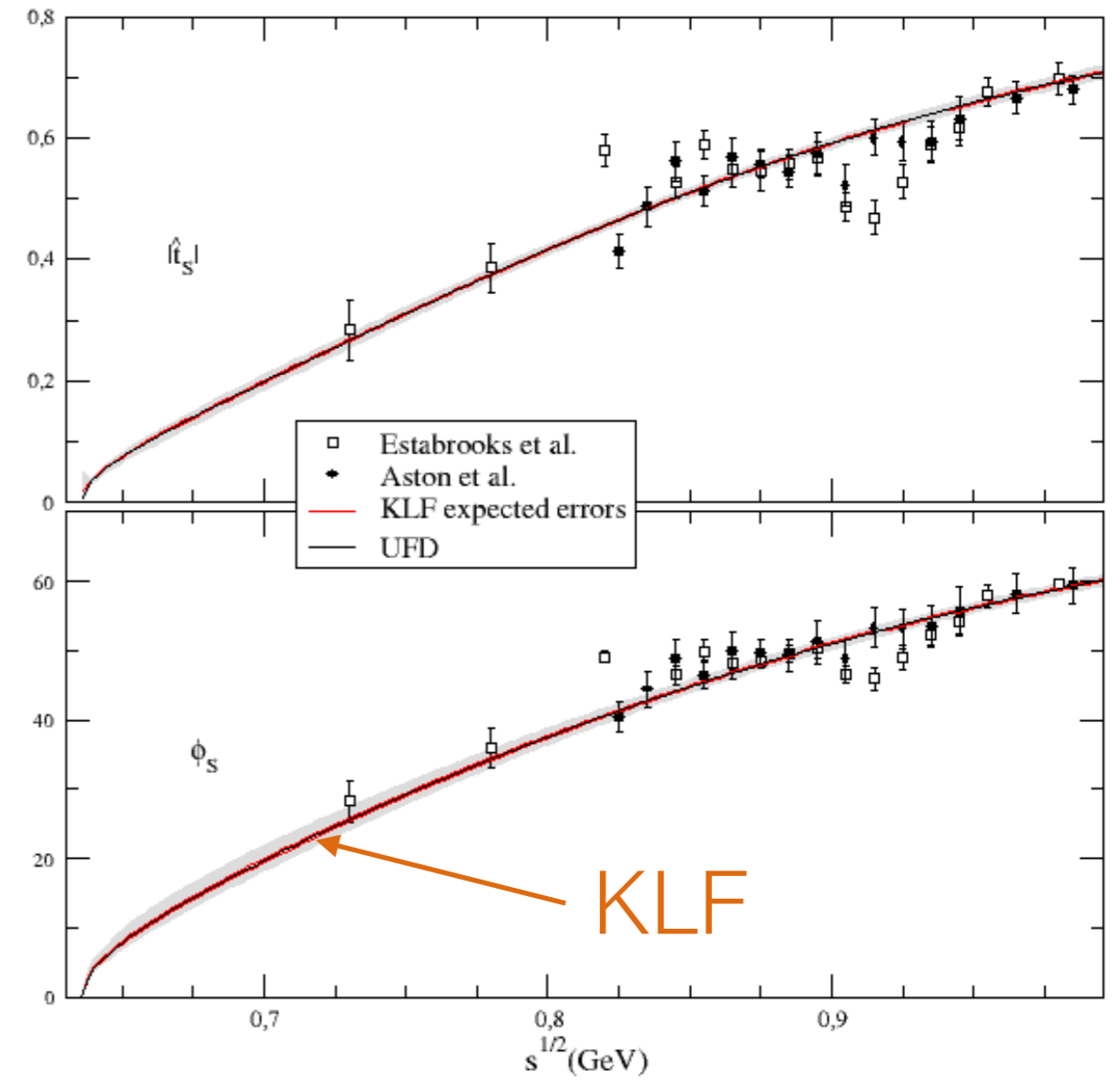
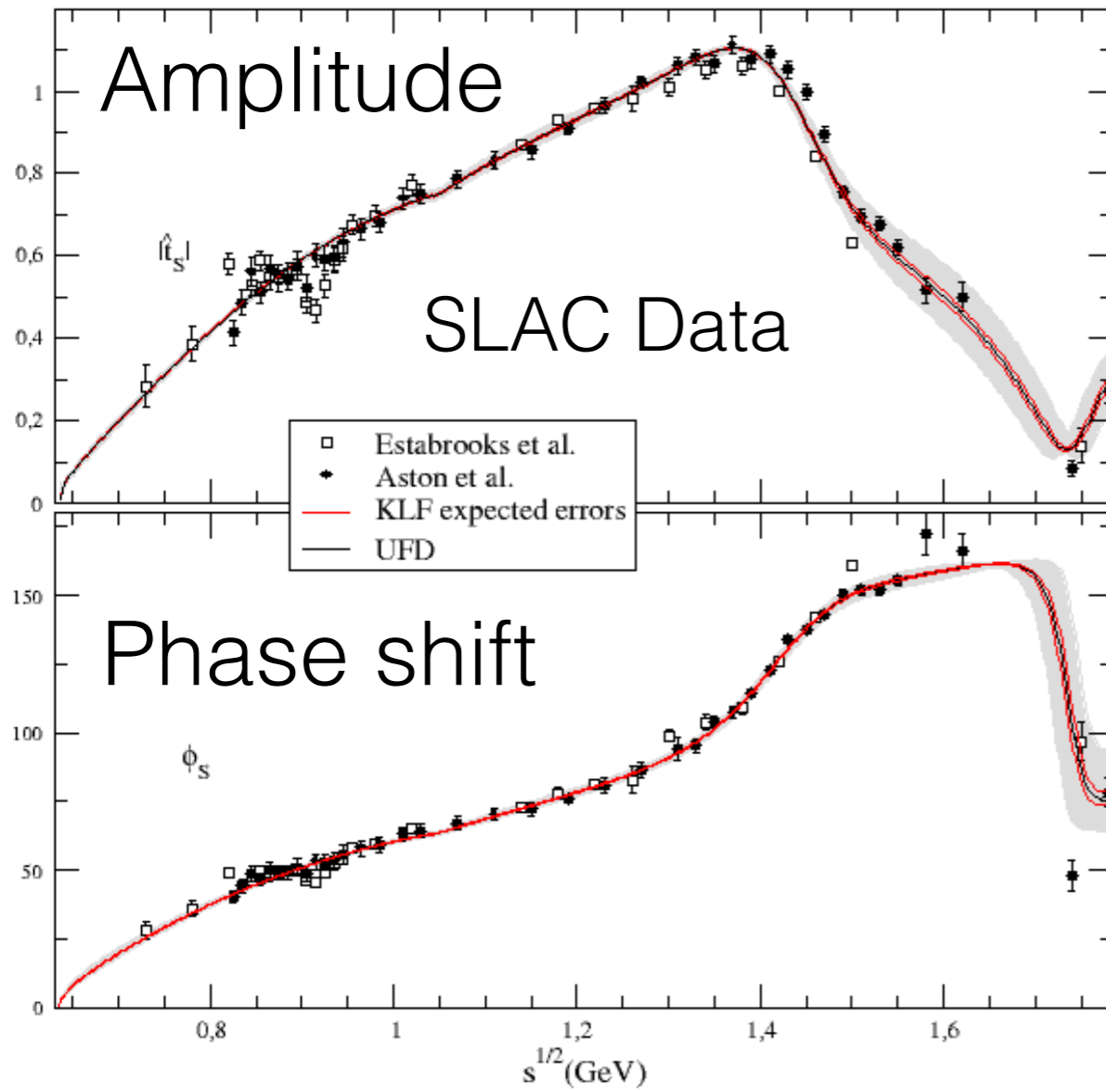

# Scalar Meson Nonet

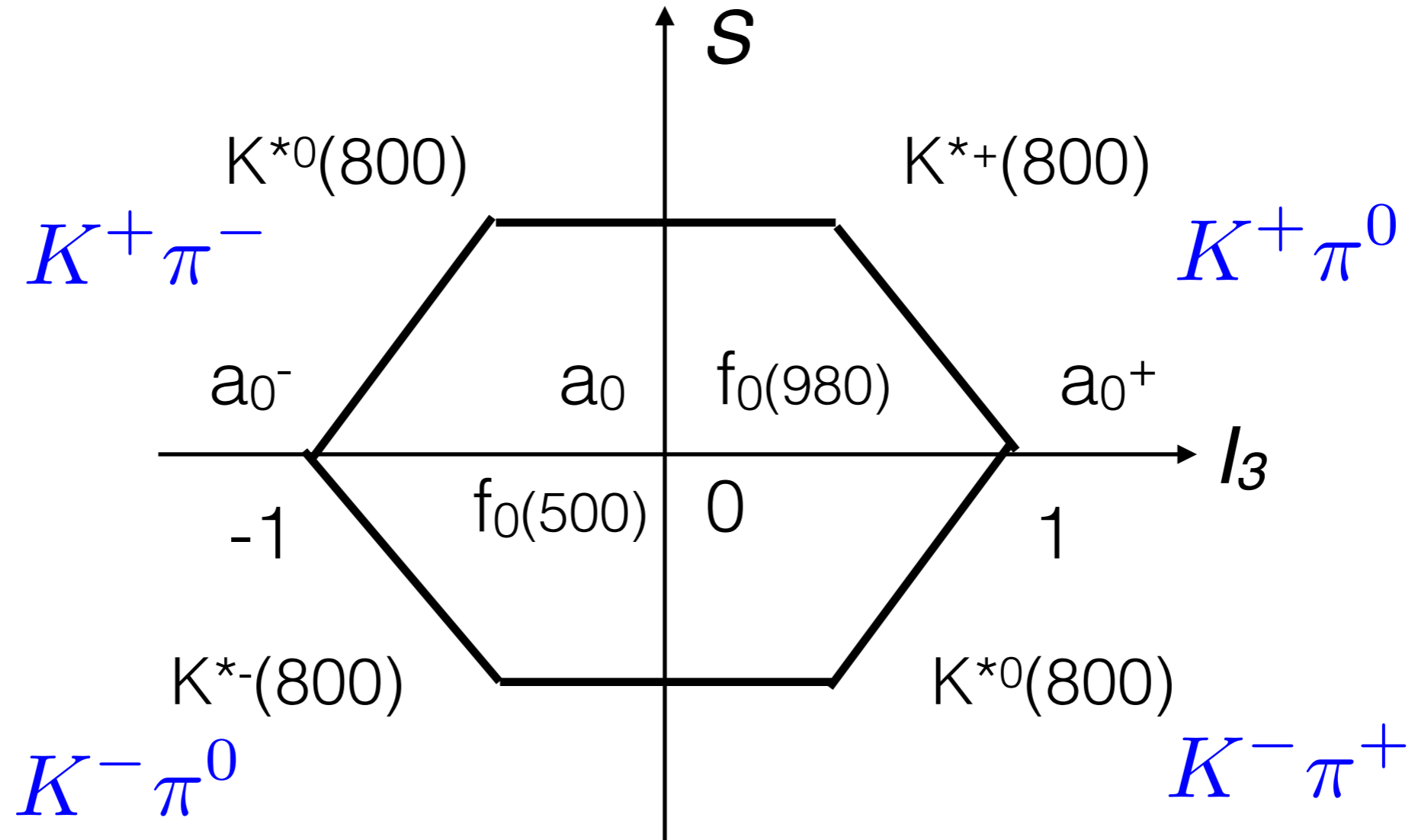

**Four states called  $\kappa$**

**still need further confirmation(PDG)**

**We can measure all of them**

# Measurement of $\kappa(800)$

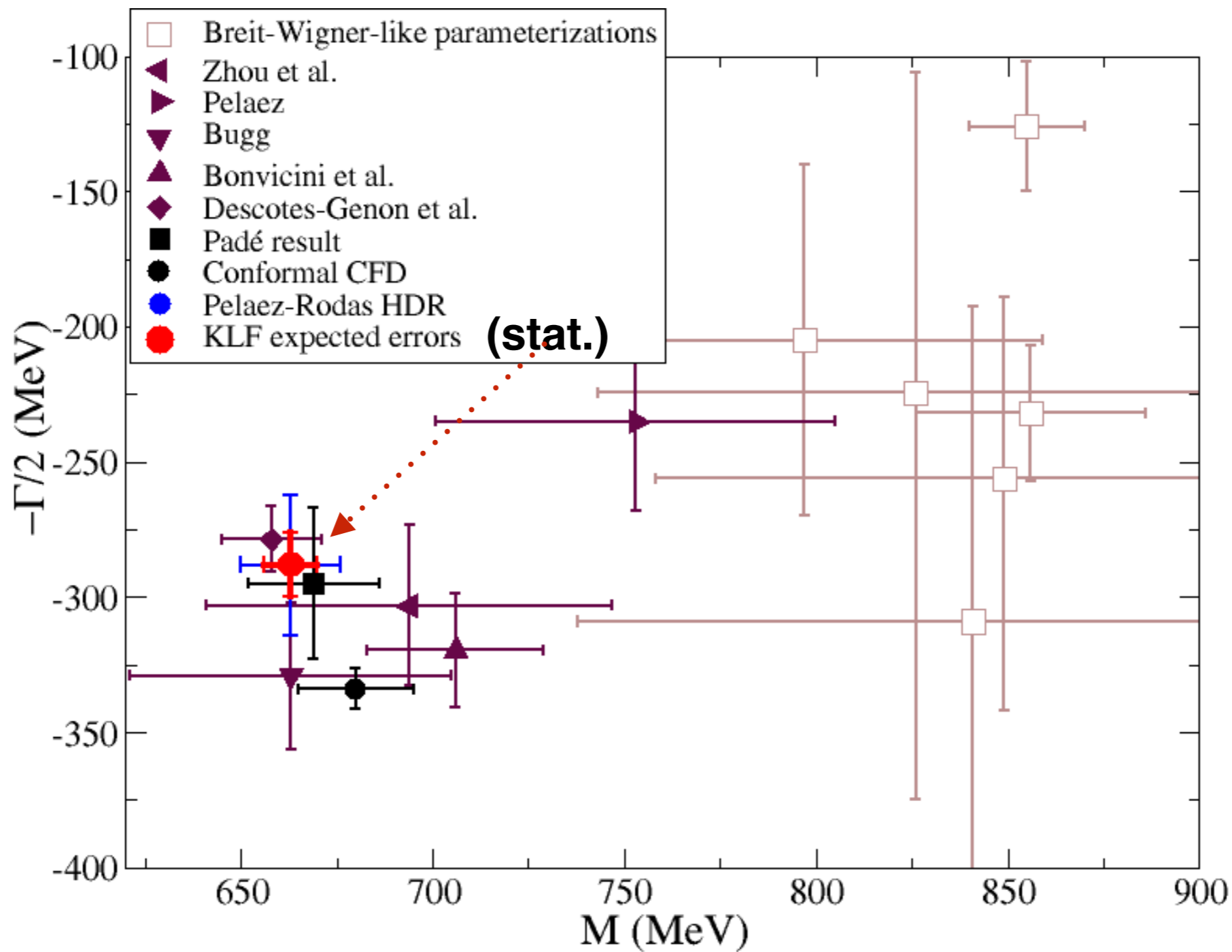

*100 days of running*

# Hall-D beamline and GlueX Setup

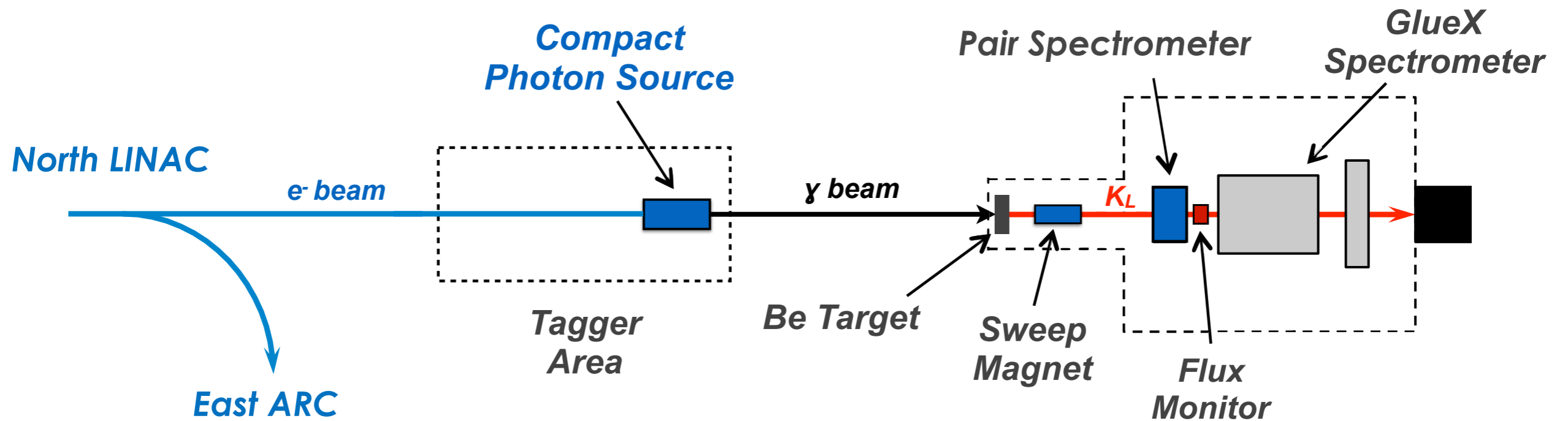

## *Electron Beam Parameters*

$$E_e = 12 \text{ GeV} \quad I = 5 \mu\text{A}$$

$$\text{Repetition rate} \quad 64 \text{ ns}$$

*No major problems.*

**Doable !**

**Confirmed by Todd Satogata**

**Estimated investment ~\$60 K for injector upgrade**

# Compact Photon Source

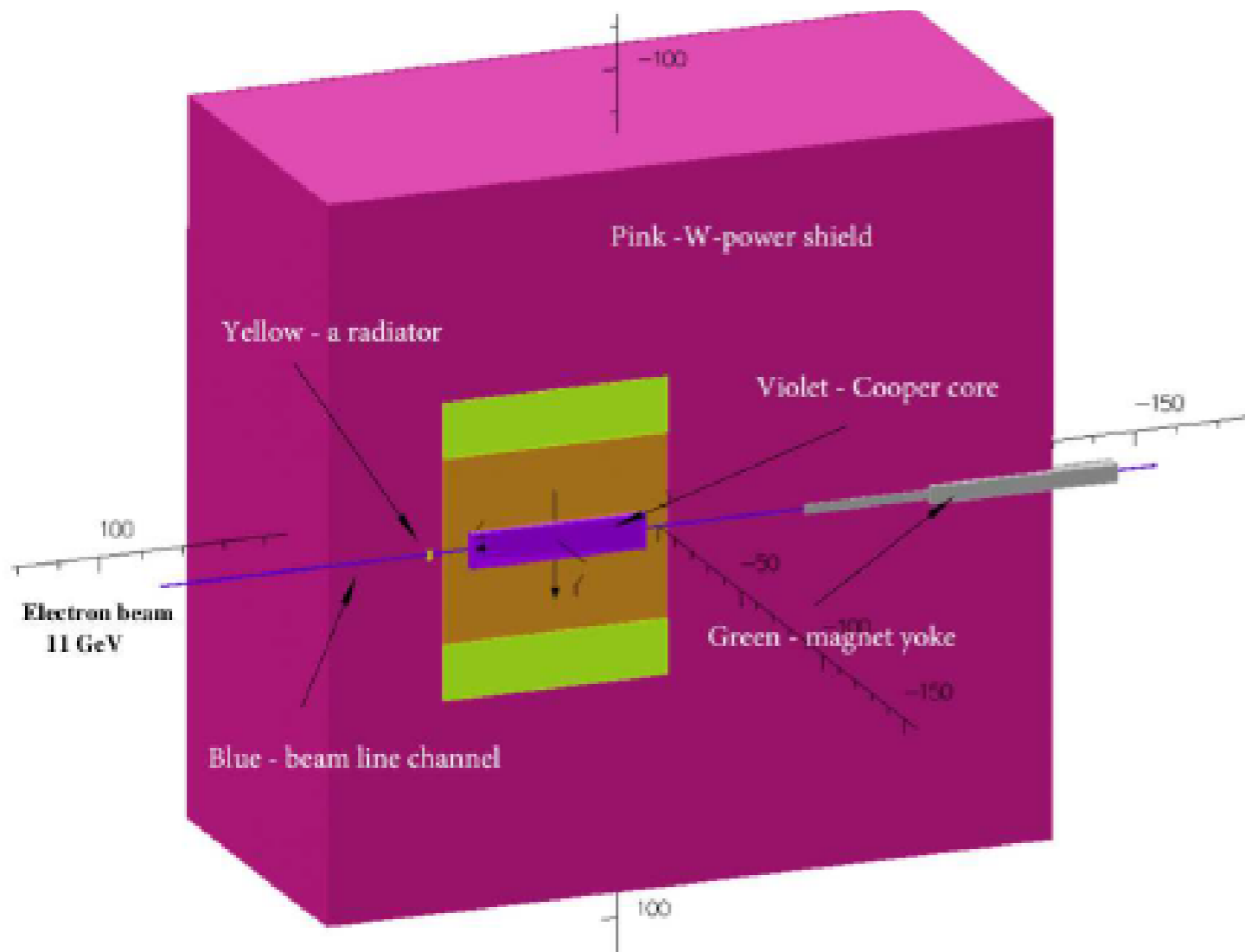

**Conceptual design is completed for Halls C/A for  $I = 2.7 \mu A$**

**Could be extended for  $I = 5 \mu A$  in Hall D**

**The details of the CPS are designed by the CPS Collaboration**

**Meets RadCon Radiation Requirements**

**Estimated cost \$1.5-2.0 M**







# $K_L$ Beam Flux

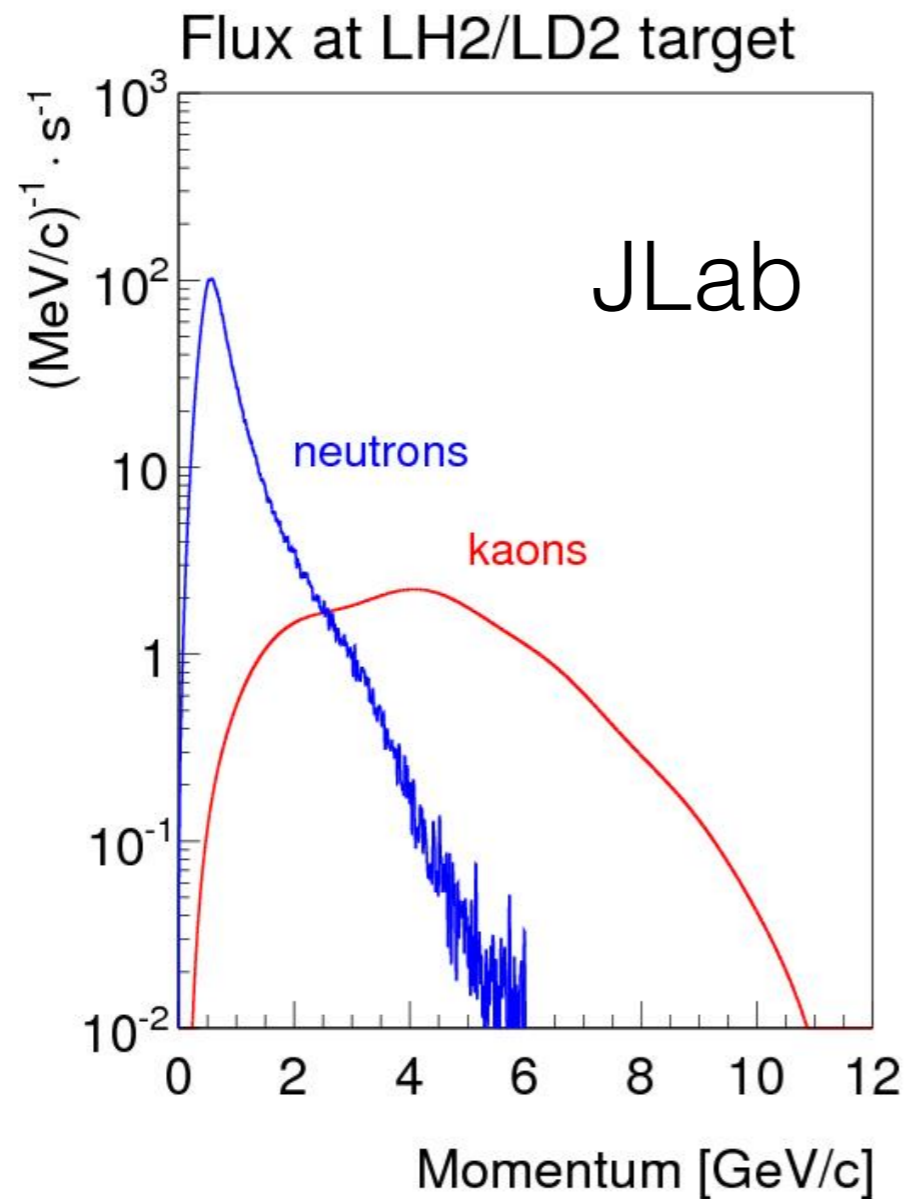

$$N(K_L)/sec \sim 10^4$$

# SLAC

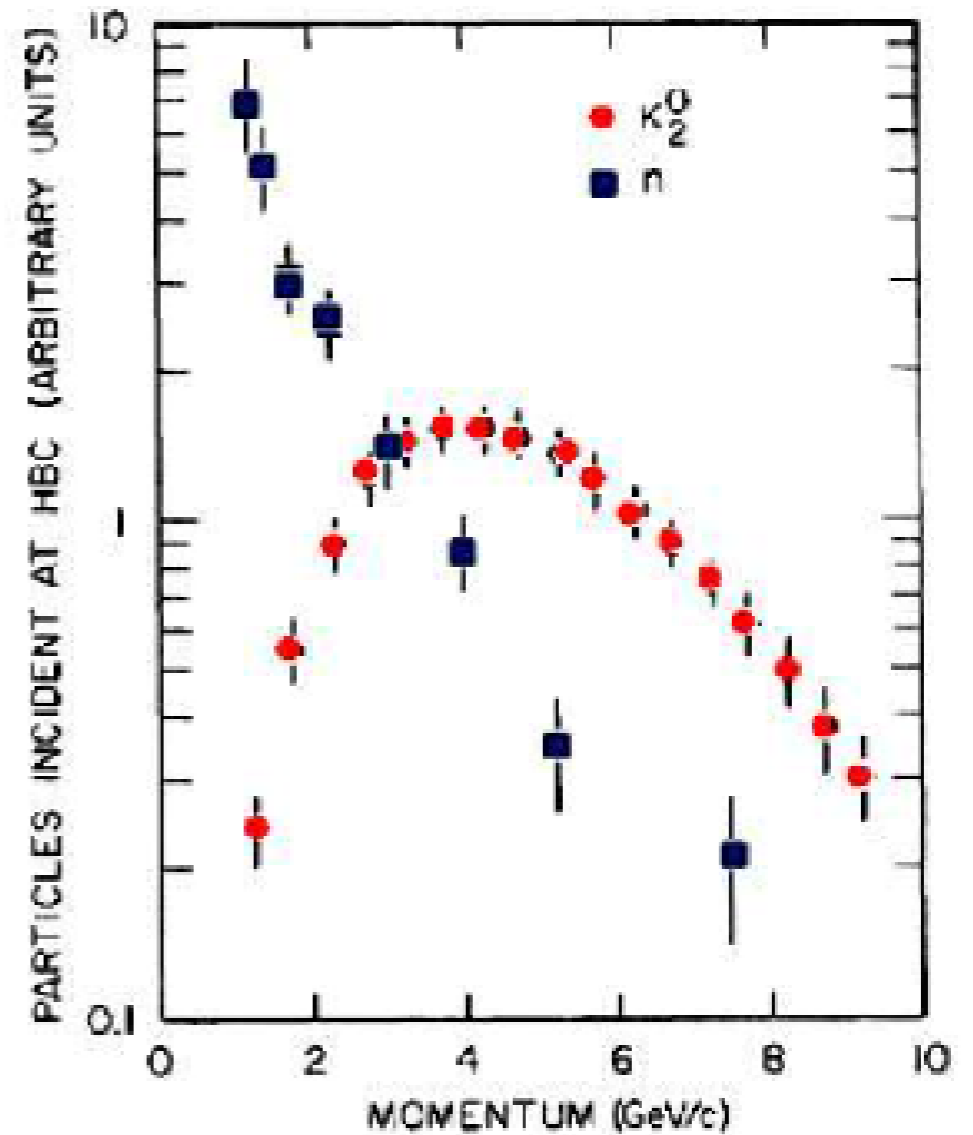

$$\frac{N(K_L)_{JLAB}}{N(K_L)_{SLAC}} \sim 10^3$$

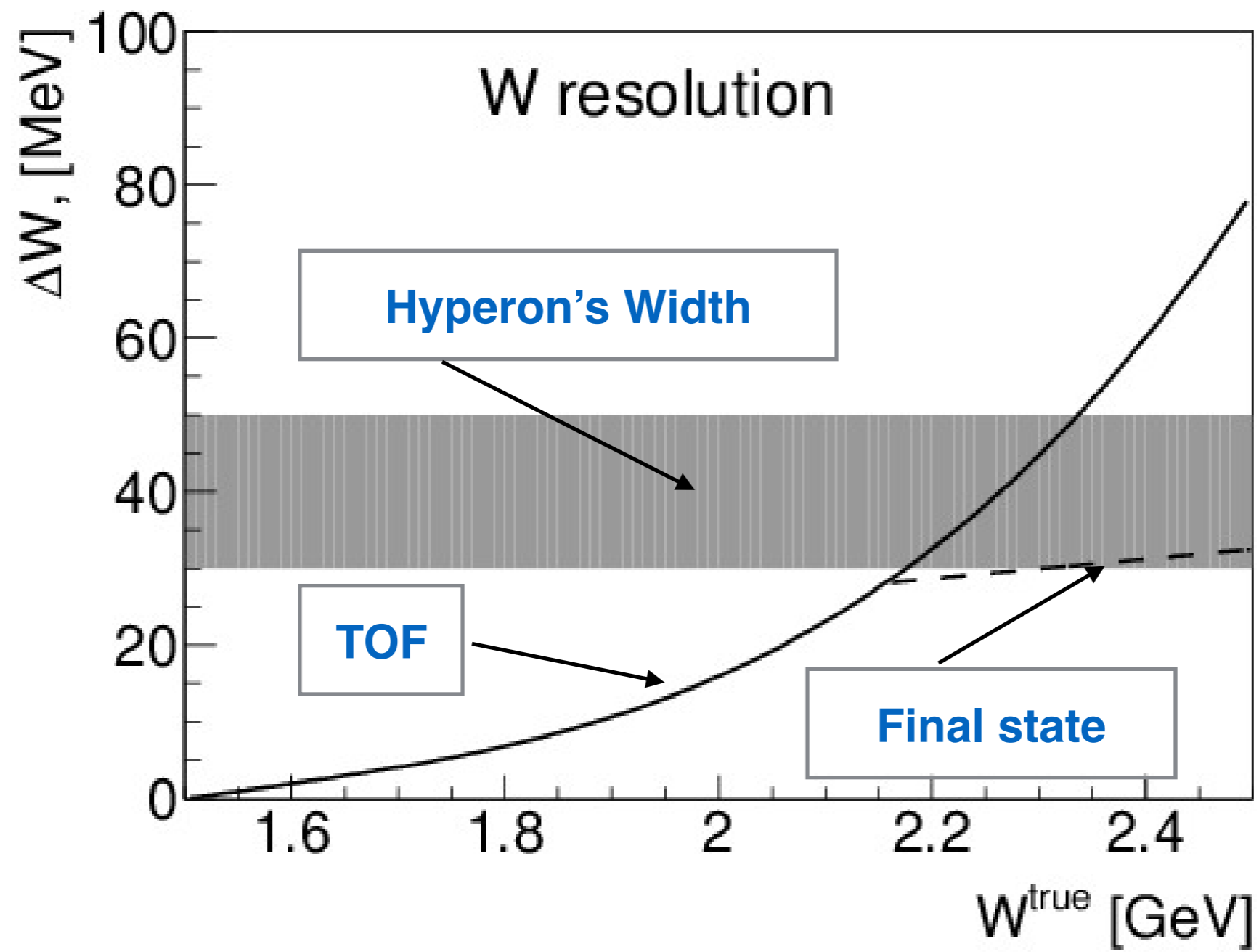

# LH<sub>2</sub>/LD<sub>2</sub> Cryogenic Target for Neutral Kaon Beam at Hall D

The GlueX liquid hydrogen target.

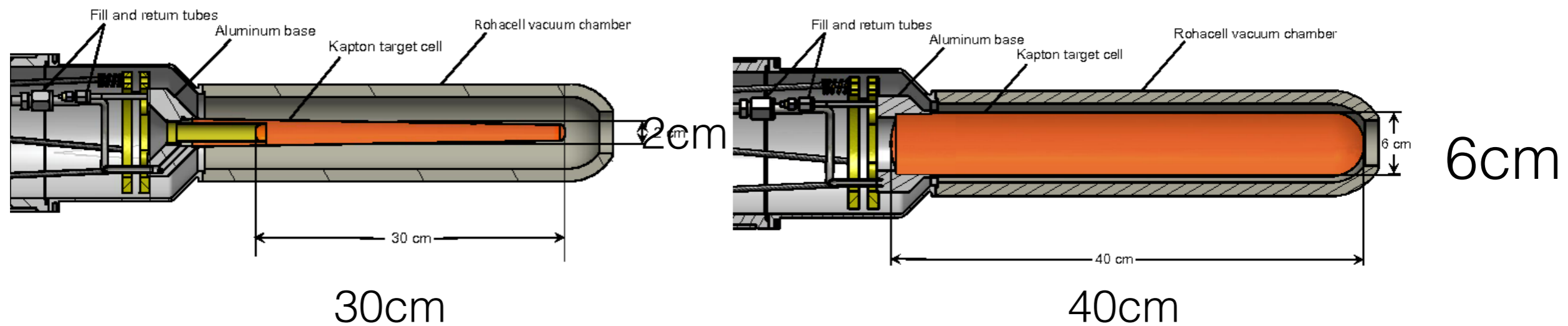

*Current*

*Proposed & Feasible*

**Longer and thicker target is needed to enhance production rate**

**Conceptual design endorsed by target group (Chris Keith)**

**Estimated cost ~\$ 30 K**

# $K\pi$ Scattering Resolutions

Four Momentum Resolution for  $K_L p \rightarrow K^+ \pi^- p$

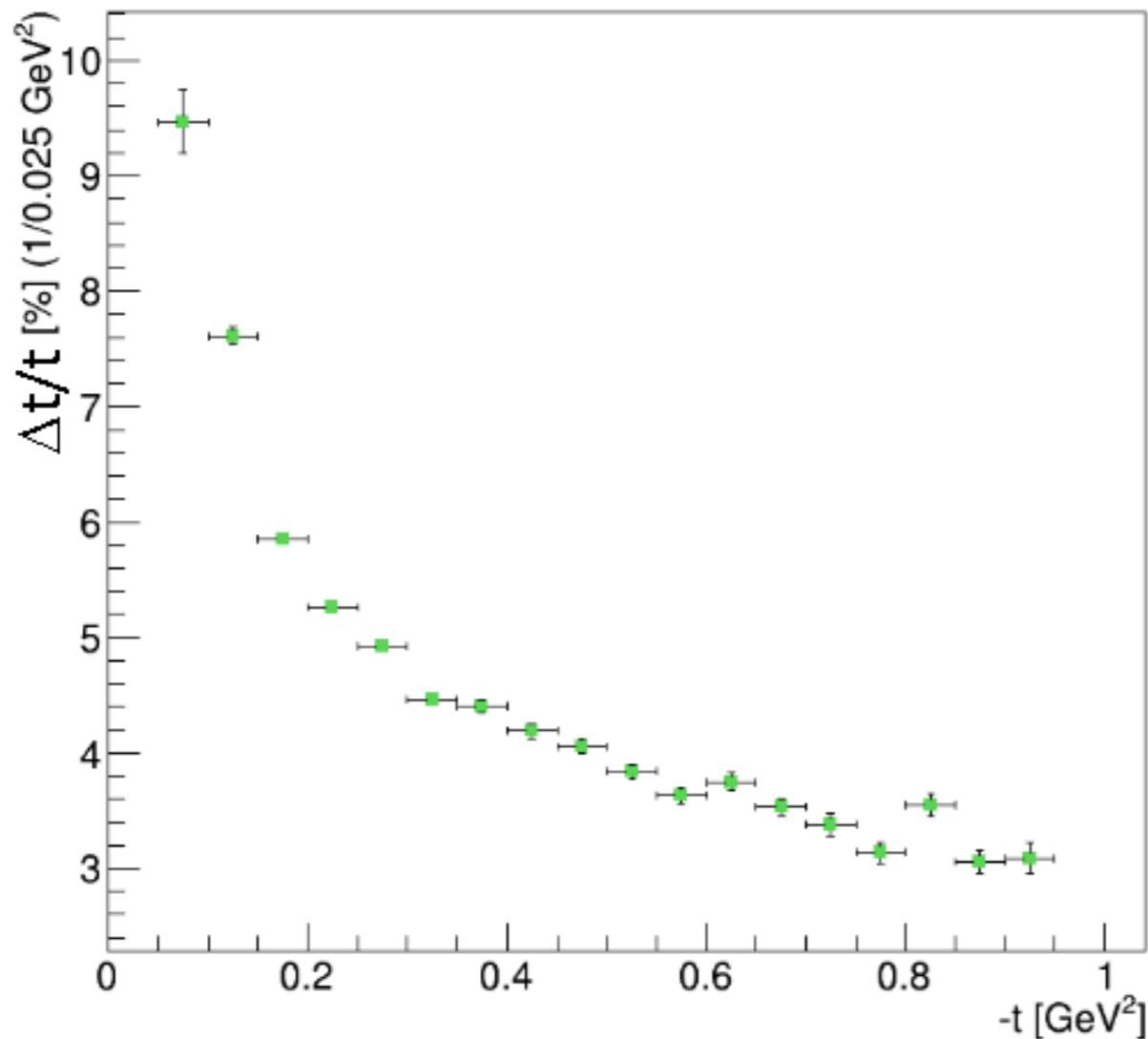

*-Good resolution at low- $t$  is needed to be on pion pole*

$K^+ \pi^-$  Invariant Mass Resolution for  $K_L p \rightarrow K^+ \pi^- p$

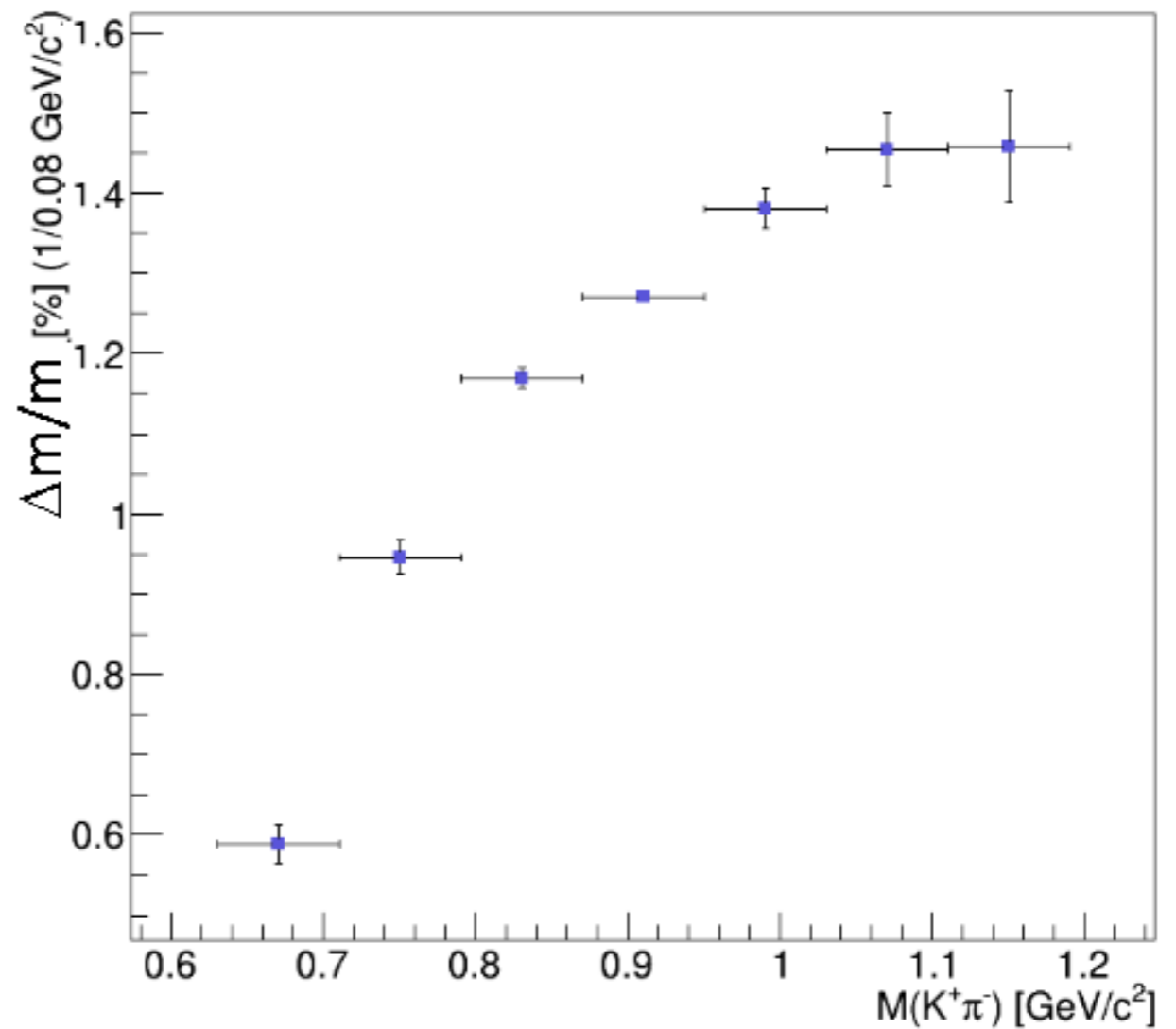

*-Binning in  $\sim 10 \text{ MeV}$  will cover almost entire elastic  $K$ - $\pi$  scattering range*

# PHYSICS WITH NEUTRAL KAON BEAM AT JLAB KL2016

FEBRUARY 1-3, 2016  
JEFFERSON LAB  
NEWPORT NEWS, VIRGINIA

## SCOPE

The Workshop is following L012-15-001 "Physics Opportunities with Secondary KL beam at JLab" and will be dedicated to the physics of hyperons produced by the kaon beam on unpolarized and polarized targets with GlueX set up in Hall D. The emphasis will be on the hyperon spectroscopy. Such studies could contribute to the existing scientific program on hadron spectroscopy at Jefferson Lab.

The Workshop will also aim at boosting the international collaboration, in particular between the US and EU research institutions and universities.

The Workshop would help to address the comments made by the PAC43, and to prepare the full proposal for the next PAC44.

## ORGANIZING COMMITTEE

Moskov Amaryan, ODU, chair  
Eugene Chudakov, JLab  
Curtis Meyer, CMU  
Michael Pennington, JLab  
James Ritman, Ruhr-Uni-Bochum & IKP Jülich  
Igor Strakovsky, GWU

[WWW.JLAB.ORG/CONFERENCES/KL2016](http://WWW.JLAB.ORG/CONFERENCES/KL2016)



# YSTAR Excited Hyperons in QCD Thermodynamics at Freeze-Out 2016

NOVEMBER 16-17, 2016

Jefferson Lab  
Newport News, Virginia

A workshop to discuss the influence of possible "missing" hyperon resonances (JLab KLF Project) on QCD thermodynamics, on freeze-out in heavy ion collisions and in the early universe, and in spectroscopy. Recent studies that compare lattice QCD calculations of thermodynamic calculations, statistical hadron resonance gas models, and ratios between measured yields of different hadron species in heavy ion collisions provide indirect evidence for the presence of "missing" resonances in all of these contexts. The aim of the workshop is to sharpen these comparisons, advance our understanding of the formation of baryons from quarks and gluons microseconds after the Big Bang and in today's experiments, and to connect these developments to experimental searches for direct, spectroscopic, evidence for these resonances. This Workshop is a successor to the recent KL2016 Workshop

## ORGANIZING COMMITTEE

Moskov Amaryan - Chair, ODU  
Eugene Chudakov, JLab  
Krishna Rajagopal, MIT  
Chandia Ratti, University of Houston  
James Ritman, Ruhr U. Bochum & IKP Jülich  
Igor Strakovsky, GWU



[WWW.JLAB.ORG/CONFERENCES/YSTAR2016/](http://WWW.JLAB.ORG/CONFERENCES/YSTAR2016/)



# HIPS 2017

New Opportunities with High-Intensity Photon Sources

February 6-7, 2017  
Catholic University of America  
Washington, DC U.S.A.

This workshop aims at producing an optimized photon source concept with potential increase of scientific output at Jefferson Lab, and at refining the science for hadron physics experiments benefiting from such a high-intensity photon source. The workshop is dedicated to bringing together the communities directly using such sources for photo-production experiments, or for conversion into  $K_s$  beams. The combination of high precision calorimetry and high intensity photon sources can provide greatly enhanced scientific benefit to (deep) exclusive processes like wide-angle and time-like Compton scattering. Potential prospects of such a high-intensity source with modern polarized targets will also be discussed. The availability of  $K_s$  beams would open new avenues for hadron spectroscopy, for example for the investigations of "missing" hyperon resonances, with potential impact on QCD thermodynamics and on freeze-out both in heavy ion collisions and the early universe.

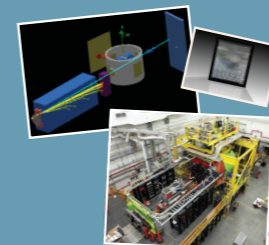

## Organizing Committee:

Tanja Horn - CUA  
Cynthia Keppel - JLab  
Carlos Munoz-Camacho - IPNO  
Igor Strakovsky - GWU



# $\pi$ -K Interactions Workshop

## ORGANIZING COMMITTEE

Moskov Amaryan, ODU (Chair)  
U.G. Meissner, U. Bonn/FZ Jülich  
Curtis Meyer, CMU  
James Ritman, Ruhr-Uni-Bochum/FZ Jülich  
Igor Strakovsky, GWU

February 14-15, 2018

Jefferson Lab • Newport News, VA

The  $\pi$ -K scattering enables direct investigations of scalar and vector  $K^*$  states, including the not yet established S-wave  $k(800)$  state. These studies are also needed to get precise values of vector and scalar form factors: to independently extract CKM matrix element  $V_{us}$  and to test the Standard Model unitarity relation in the first row of CKM matrix, to study CP violation from the Dalitz plot analysis of open charm D meson decays and in a charmless decays of B mesons in Kpipi final states. Significant progress is made lately in Lattice QCD, in the phenomenology and in the Chiral Perturbation Theory to describe different aspects of  $\pi$ -K scattering. The main source of experimental data is based on experiments performed in SLAC almost five decades ago at 1970-80s. The recently proposed KL Facility incorporating the GlueX spectrometer at JLab will be able to improve the  $\pi$ -K scattering database by about three orders of magnitude in statistics. The workshop will discuss the necessity for and the impact of the future high statistics data obtained at JLab on  $\pi$ -K scattering.

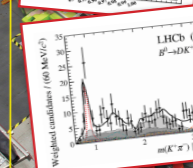
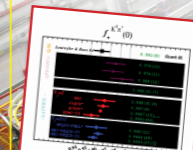
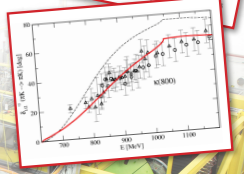
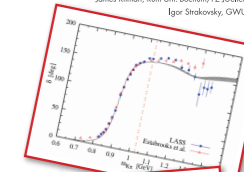

<https://www.jlab.org/conferences/pki2018/>



## KL2016

[60 people from 10 countries, 30 talks] <https://www.jlab.org/conferences/kl2016/>

OC: M. Amaryan, E. Chudakov, C. Meyer, M. Pennington, J. Ritman, & I. Strakovsky

## YSTAR2016

[71 people from 11 countries, 27 talks] <https://www.jlab.org/conferences/YSTAR2016/>

OC: M. Amaryan, E. Chudakov, K. Rajagopal, C. Ratti, J. Ritman, & I. Strakovsky

## HIPS2017

[43 people from 4 countries, 19 talks] <https://www.jlab.org/conferences/HIPS2017/>

OC: T. Horn, C. Keppel, C. Munoz-Camacho, & I. Strakovsky

## PKI2018

[48 people from 9 countries, 27 talks] <http://www.jlab.org/conferences/pki2018/>

OC: M. Amaryan, U.-G. Meissner, C. Meyer, J. Ritman, & I. Strakovsky

# In total: 222 participants & 103 talks

**Proposal:**  
**200 Members**  
**61 Institutions**  
**20 Countries**

A. Ali<sup>18</sup>, M. B. Ali<sup>47</sup>, M. J. Amaryan<sup>44,\*†</sup>, E. G. Anassontzis<sup>2</sup>, A. V. Anisovich<sup>4,48</sup>,  
A. Austregesilo<sup>30</sup>, M. Baalouch<sup>45</sup>, F. Barbosa<sup>30</sup>, J. Barlow<sup>13</sup>, A. Barnes<sup>7</sup>, E. Barriga<sup>13</sup>,  
M. Bashkanov<sup>10,†</sup>, A. Bazavov<sup>39</sup>, T. D. Beattie<sup>50</sup>, R. Bellwied<sup>20</sup>, V. V. Berdnikov<sup>8</sup>, T. Black<sup>42</sup>,  
W. Boeglin<sup>12</sup>, M. Boer<sup>8</sup>, W. J. Briscoe<sup>14</sup>, T. Britton<sup>30</sup>, W. K. Brooks<sup>53</sup>, B. E. Cannon<sup>13</sup>, N. Cao<sup>22</sup>,  
E. Chudakov<sup>30</sup>, P. L. Cole<sup>21</sup>, S. Cole<sup>1</sup>, V. Crede<sup>13</sup>, M. M. Dalton<sup>30</sup>, T. Daniels<sup>42</sup>, D. Day<sup>58</sup>,  
P. Degtyarenko<sup>30</sup>, A. Deur<sup>30</sup>, S. Dobbs<sup>13</sup>, G. Dodge<sup>45</sup>, A. G. Dolgolenko<sup>27</sup>, M. Döring<sup>14,30</sup>,  
M. Dugger<sup>1</sup>, R. Dzhygadlo<sup>18</sup>, S. Eidelman<sup>5,44</sup>, R. Edwards<sup>30</sup>, H. Egiyan<sup>30</sup>, A. Ernst<sup>13</sup>,  
A. Eskandarian<sup>14</sup>, P. Eugenio<sup>13</sup>, C. Fanelli<sup>36</sup>, S. Fegan<sup>14</sup>, A. Filippi<sup>25</sup>, A. M. Foda<sup>50</sup>, J. Frye<sup>23</sup>,  
S. Furletov<sup>30</sup>, L. Gan<sup>42</sup>, A. Gasparyan<sup>41</sup>, G. Gavalian<sup>30</sup>, M. Gauzshtein<sup>54,55</sup>, N. Gevorgyan<sup>61</sup>,  
C. Gleason<sup>23</sup>, D. I. Glazier<sup>17</sup>, J. Goity<sup>30,19</sup>, V. S. Goryachev<sup>27</sup>, K. Götzen<sup>18</sup>, A. Goncalves<sup>13</sup>,  
L. Guo<sup>12</sup>, H. Haberzettl<sup>14</sup>, M. Hadžimehmedović<sup>57</sup>, H. Hakobyan<sup>53</sup>, A. Hamdi<sup>18</sup>, S. Han<sup>60</sup>,  
J. Hardin<sup>36</sup>, A. Hayrapetyan<sup>16</sup>, G. M. Huber<sup>50</sup>, A. Hurley<sup>59</sup>, C. E. Hyde<sup>45</sup>, T. Horn<sup>8</sup>,  
D. G. Ireland<sup>17</sup>, M. Ito<sup>30</sup>, N. Jarvis<sup>7</sup>, R. T. Jones<sup>9</sup>, V. Kakoyan<sup>61</sup>, G. Kalicy<sup>8</sup>, M. Kamel<sup>12</sup>,  
C. D. Keith<sup>30</sup>, C. W. Kim<sup>14</sup>, F. J. Klein<sup>14</sup>, C. Kourkoumeli<sup>2</sup>, G. Krafft<sup>30</sup>, S. Kuleshov<sup>53</sup>,  
I. Kuznetsov<sup>54,55</sup>, A. B. Laptev<sup>33</sup>, I. Larin<sup>35</sup>, D. Lawrence<sup>30</sup>, D. I. Lersch<sup>13</sup>, M. Levillain<sup>41</sup>, H. Li<sup>7</sup>,  
W. Li<sup>59</sup>, K. Livingston<sup>17</sup>, B. Liu<sup>22</sup>, G. J. Lolos<sup>50</sup>, V. E. Lyubovitskij<sup>56,54,55,53</sup>, D. Mack<sup>30</sup>,  
M. Mai<sup>14</sup>, D. M. Manley<sup>31</sup>, M. Mazouz<sup>47</sup>, H. Marukyan<sup>61</sup>, V. Mathieu<sup>30</sup>, P. T. Mattione<sup>30</sup>,  
M. Matveev<sup>48</sup>, V. Matveev<sup>27</sup>, M. McCaughan<sup>30</sup>, W. McGinley<sup>7</sup>, M. McCracken<sup>7</sup>, J. McIntyre<sup>9</sup>,  
U.-G. Meißner<sup>4,29</sup>, V. Mokeev<sup>30</sup>, F. Nerling<sup>18</sup>, C. A. Meyer<sup>7</sup>, R. Miskimen<sup>35</sup>, R. E. Mitchell<sup>23</sup>,  
F. Mokaya<sup>9</sup>, C. Morningstar<sup>7</sup>, B. Moussallam<sup>46</sup>, K. Nakayama<sup>15</sup>, Y. Oh<sup>32</sup>, R. Omerović<sup>57</sup>,  
H. Osmanović<sup>57</sup>, A. Ostrovidov<sup>13</sup>, Z. Papandreou<sup>50</sup>, K. Park<sup>30</sup>, E. Pasyuk<sup>30</sup>, M. Patsyuk<sup>36</sup>,  
P. Pauli<sup>17</sup>, R. Pedroni<sup>41</sup>, J. R. Pelaez<sup>34</sup>, L. Pentchev<sup>30</sup>, M. R. Pennington<sup>17</sup>, K. J. Peters<sup>18</sup>,  
W. Phelps<sup>14</sup>, A. Pilloni<sup>30</sup>, E. Pooser<sup>30</sup>, J. W. Price<sup>6</sup>, N. Qin<sup>43</sup>, J. Reinhold<sup>12</sup>, D. Richards<sup>30</sup>,  
D.-O. Riska<sup>11</sup>, B. Ritchie<sup>1</sup>, J. Ritman<sup>51,28,†</sup>, L. Robison<sup>43</sup>, A. Rodas<sup>34</sup>, D. Romanov<sup>37</sup>,  
C. Romero<sup>53</sup>, J. Ruiz de Elvira<sup>3</sup>, H.-Y. Ryu<sup>49</sup>, C. Salgado<sup>40</sup>, E. Santopinto<sup>24</sup>, A. V. Sarantsev<sup>4,48</sup>,  
T. Satogata<sup>30</sup>, A. Schertz<sup>59</sup>, R. A. Schumacher<sup>7</sup>, C. Schwarz<sup>18</sup>, J. Schwiening<sup>18</sup>,  
A. Yu. Semenov<sup>50</sup>, I. A. Semenova<sup>50</sup>, K. K. Seth<sup>43</sup>, X. Shen<sup>22</sup>, M. R. Shepherd<sup>23</sup>, E. S. Smith<sup>30</sup>,  
D. I. Sober<sup>8</sup>, D. Sokhan<sup>17</sup>, A. Somov<sup>30</sup>, S. Somov<sup>37</sup>, O. Soto<sup>53</sup>, M. Staib<sup>7</sup>, J. Stahov<sup>57</sup>,  
J. R. Stevens<sup>59,†</sup>, I. I. Strakovsky<sup>14,†</sup>, A. Švarc<sup>52</sup>, A. Szczepaniak<sup>23,30</sup>, V. Tarasov<sup>27</sup>, S. Taylor<sup>30</sup>,  
A. Teymurazyan<sup>50</sup>, A. Trabelsi<sup>47</sup>, G. Vasileiadis<sup>2</sup>, D. Watts<sup>10</sup>, D. Werthmüller<sup>17</sup>, T. Whitlatch<sup>30</sup>,  
N. Wickramaarachchi<sup>45</sup>, M. Williams<sup>36</sup>, B. Wojtsekhowski<sup>30</sup>, R. L. Workman<sup>14</sup>, T. Xiao<sup>43</sup>,  
Y. Yang<sup>36</sup>, N. Zachariou<sup>10</sup>, J. Zarling<sup>23</sup>, J. Zhang<sup>58</sup>, Z. Zhang<sup>60</sup>, G. Zhao<sup>22</sup>, B. Zou<sup>26</sup>, Q. Zhou<sup>22</sup>,  
X. Zhou<sup>60</sup>, B. Zihlmann<sup>30</sup>

# SUMMARY

-Proposed KL Facility has unique capability to improve existing world database up to three orders of magnitude

**-In Hyperon spectroscopy**

PWA will allow to measure pole positions and widths of excited hyperon states

**-In Strange Meson Spectroscopy**

PWA will allow to measure excited  $K^*$  states including scalar  $f_0(800)$  states

- To accomplish physics program 100 days per LH2 and LD2 is required

**-All components of KL Facility considered are feasible**

**-With total cost less than \$ 4.0 M**

CPS(~\$ 1.5-2.0 M)

BeTarget(~\$ 1.2 M)

FluxMonitor (~\$ 0.7 M)

Electron Beam (~\$ 60K)

Cryo-Targets (~\$ 30K)



Backup

# Possible Other Impacts

$$Br(K_L \rightarrow \pi e \nu) \sim |f_+(0) V_{us}|^2$$

$$Br(\tau \rightarrow K \pi \nu) \sim |f_+(0) V_{us}|^2$$

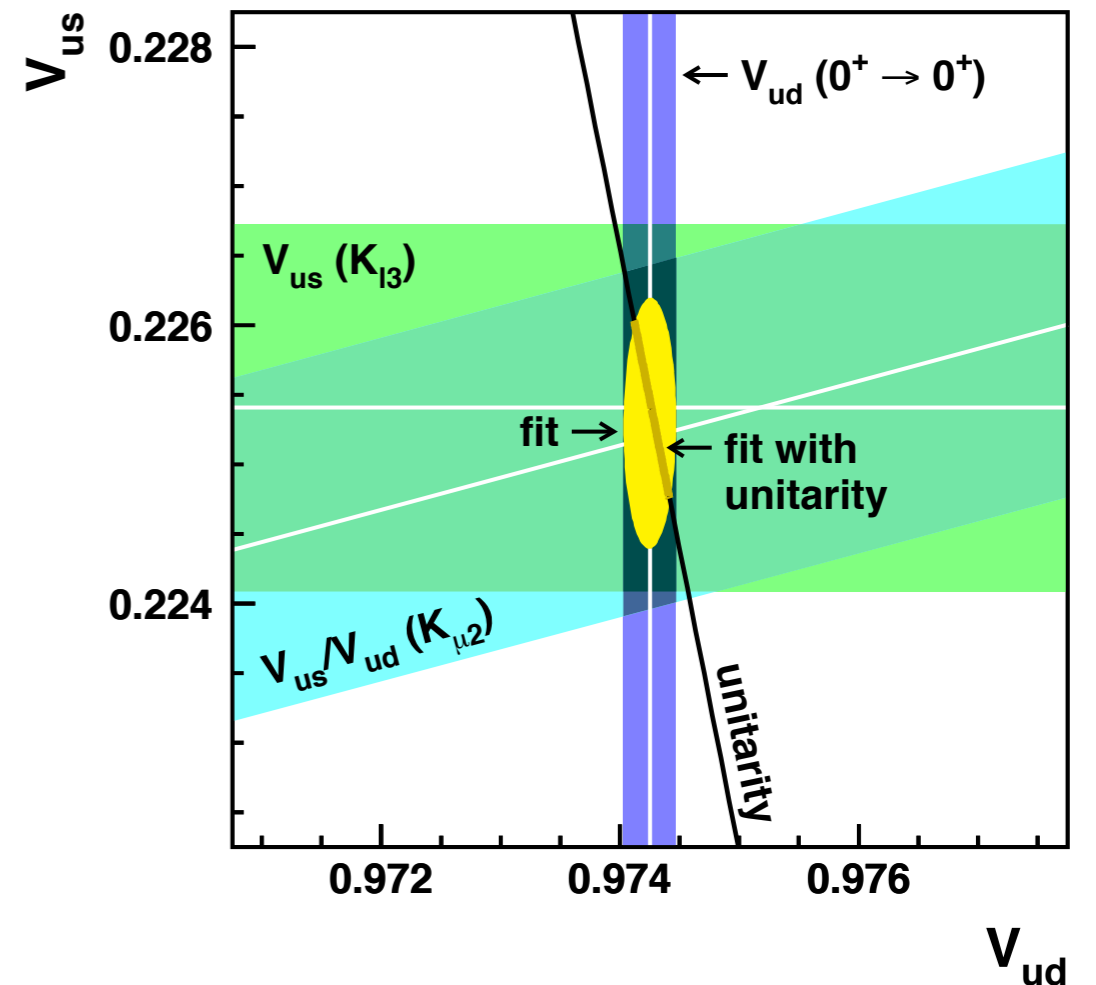
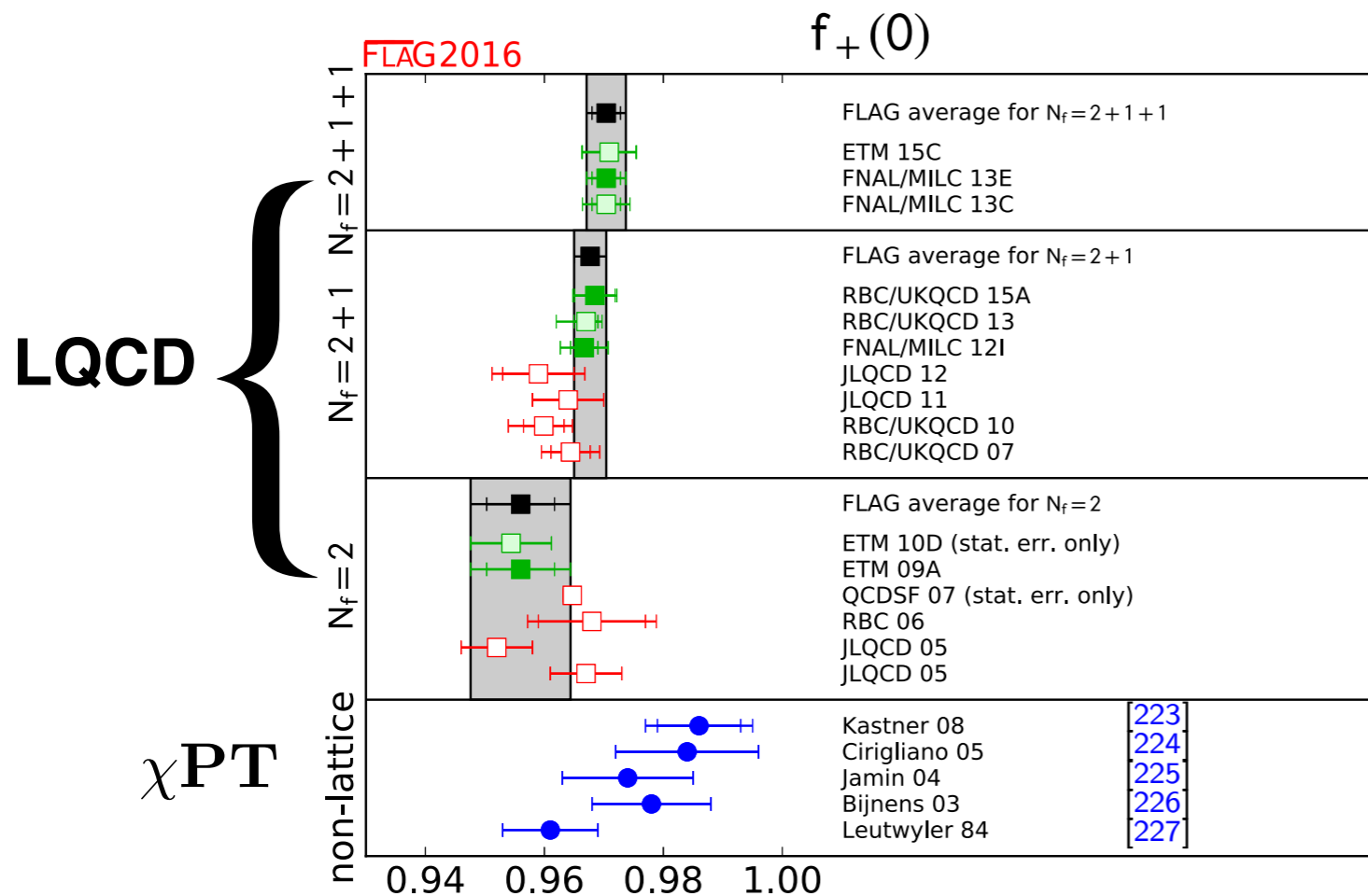

FLAG Collaboration Eur.Phys.J. C77 (2017) no.2, 112

Eur.Phys.J. C69 (2010) 399-424

*No precise data yet !*

*test of unitarity:*

$$|V_{ud}|^2 + |V_{us}|^2 + |V_{ub}|^2 = 1$$

# Cover Letter for KLF Proposal Submission to PAC46

## Issues:

Mounting this experiment will transform the existing Hall D beamline, so it represents an almost irreversible change in direction for the GlueX apparatus. As such, the physics driver must be compelling, and the PAC doesn't feel that a sufficiently convincing physics case has been made. A broad program is suggested, so the PAC would welcome a larger presentation format along the lines of a run group proposal.

The CPS design is progressing but details on the KL target and shielding for the detector need to be fleshed out.

The 64 ns beam structure will also require study to ensure that other halls are not adversely affected.

The beam time request is dominated by the hyperon polarimetry measurements. A simulated example of a PWA, and how it would feed into the proposed spectroscopy measurements, will be needed in a future proposal.

The LOI included doubly strange baryons but this topic was not much expanded upon in the proposal.

This topic remains of considerable interest.

## Summary:

This experiment would introduce a new and interesting area of physics at JLAB. The PAC recommends that the Collaboration work with the lattice and theoretical nuclear physics community to sharpen the physics case.

In addition, more details on the KL production target and shielding will be needed before we can fully assess the feasibility of the experiment. Despite the progress made in delineating the expanded physics possibilities, the very substantial beam time request would be better motivated if more details could be provided on its impact on the proposed spectroscopic measurements.

**The KLF Collaboration for the GlueX Collaboration believes that the current proposal addresses all the concerns following the recommendations expressed by the PAC45:**

**1.Q1: Mounting this experiment will transform the existing Hall D beamline, so it represents an almost irreversible change in direction for the GlueX apparatus.**

**A1: Changeover from the photon to KL beamline and from the KL beamline to photon needs to be further evaluated and in the most conservative scenario may take approximately 6 months or less. This maximal break period may fit the current CEBAF Accelerator schedule. It has to be mentioned that the collimator cave has enough space (with the 4.52 m width) for the Be-target assembly to remain far enough from the beamline.**

**2. Q2: As such, the physics driver must be compelling, and the PAC doesn't feel that a sufficiently convincing physics case has been made. A broad program is suggested, so the PAC would welcome a larger presentation format along the lines of a run group proposal.**

**A2: With the current proposal, we aim to show the broad range of outstanding problems related to strange hadron spectroscopy, which can be solved by improving the existing database by orders of magnitude. We believe, the run group proposals will naturally occur when the proposed facility is approved.**

**In particular, we are focusing on studies of doubly strange cascade baryons and the kappa-meson. Following Bob McKeown's suggestion, we plan to have three presentations at the PAC46 meeting:**

- (a) KL Beam Facility at GlueX;**
- (b) Hyperon Spectroscopy with a KL Beam;**
- (c) Strange Mesons with a KL Beam.**

**3. Q3: The CPS design is progressing but details on the KL target end shilling for the detector need to be fleshed out.**

**A3: Following to that, we improved the conceptual design for both the CPS (Sec. 10.1.2) and the Be- target (KL production target) (Sec. 10.1.3)**

**4. Q4: The 64 ns beam structure will also require study to ensure that other halls are not adversely affected**

**A4: According to our discussions with accelerator experts (Geoff Krafft, Matt Poelker, Todd Satogata, Jay Benisch, Reza Kazimi, and Joe Grames) following the iTAC Report for PAC45 it has been explicitly stated that no problems are expected for a 64 ns beam structure from the beam delivery point of view. Todd is member of our team and we do have a Section 10.1.1 addressing this task. In order to build up a beamline delivery system for the secondary KL beam a rough estimate is for about \$10k the pulse picking system and about \$50k for the laser amplifier.**

**5. Q5: A simulated example of a partial wave analysis, and how it would feed into the proposed spectroscopic measurements, will be needed in a future proposal.**

**A5: We generated quasi-data for the toy PWA model for spectroscopy of hyperons to demonstrate impact of the proposed experiment on the world knowledge (Sec. 11.1.6). The results will be presented during PAC46.**

**6. Q6: The LOI included doubly strange baryons but this topic was not much expanded upon in the proposal. This topic remains of considerable interest.**

**A6: We made two cases with doubly strange baryons (Sec. 3.1) and pion-kaon interactions (Sec. 9) more compelling.**

**7. Q7: The PAC recommends that the Collaboration work with the lattice and theoretical nuclear physics community to sharpen the physics case.**

**A7: We are collaborating closely with the lattice and theory community. In addition, we had the forth Workshop PKI2018 [12] hosted at JLab recently and dedicated to the physics of strange mesons produced by the neutral kaon beam.**

**Meanwhile, many lattice and theory researchers are co-authors of our proposal and our proposal has a significant contribution from them.**

**8. Q8: In addition, more details on the KL production target and shielding will be needed before we can fully assess the feasibility of the experiment.**

**A8: All is done (see A3).**



**9. Q9: Despite the progress made in delineating the expanded physics possibilities, the very substantial beam time request would be better motivated if more details could be provided on its impact on the proposed spectroscopic measurements.**

**A9: We believe that the current proposal addresses all the concerns following the recommendations expressed by the PAC45. The new data will significantly constrain PWAs and reduce model-dependent uncertainties in the extraction of the properties and pole positions of the strange hyperon resonances, and establish the orbitally excited multiplets in the spectra of the  $\Xi$  and  $\Omega$  hyperons.**

**The experiment will settle the still open issue of the existence or non-existence of the low lying strange scalar meson  $\kappa(800)$ . All details will be presented during PAC46.**