



K-long Facility at JLab for the Strange Hadron Spectroscopy

Moskov Amaryan

Old Dominion University
Norfolk, VA. USA

JLab, IERR, 29 August, 2024

Outline

-Introduction

-Physics Motivation

- *Hyperon Spectroscopy* (Talks by V. Baturin, M. Scott, S. Fegan)
- *Strange Meson Spectroscopy* (Talk by Keigo Mizutani)

- K_L Facility Beamline and Hardware (Brief introduction)

- *Electron Beam*
- *Compact Photon Source*
- *Be Target*
- *Flux Monitor* (Talk by M. Bashkanov)
- *K_L Beam*
- *LH_2/LD_2 Target*

Summary

2

48th PROGRAM ADVISORY COMMITTEE (PAC 48)

August 10-14, 2020

September 25, 2020



Recommendations

PAC 48 SUMMARY OF RECOMMENDATIONS								
Number	Contact Person	Title	Hall	Days Req'd	Days Awarded	Scientific Rating	PAC Decision	Topic
C12-18-005	M. Boer	Timelike Compton Scattering Off Transversely Polarized Proton	C	50			C2	4
C12-19-001	M. Amarian	Strange Hadron Spectroscopy with Secondary KL Beam in Hall D	D	200	200	A-	Approved	1

Title: Strange Hadron Spectroscopy with Secondary KL Beam in Hall D

Spokespersons: M. Amaryan (contact), M. Bashkanov, S. Dobbs, J. Ritman, J. Stevens, I. Strakovsky

Motivation: The spectroscopy of strange baryons and mesons, including their fundamental strong interactions, are the focus of this proposal. New and unique data can be obtained with an intense K_L beam aimed at a hydrogen/deuterium target, using the GlueX apparatus to detect final state particles.

Measurement and Feasibility: The proponents have answered all questions outlined in the PAC47 report. Substantial progress has been made on the issues of simulations: details on backgrounds and background reactions have been demonstrated, a demonstration of partial wave analysis for hyperon production was given. The proponents have demonstrated the measuring technique of missing mass reconstruction, allowing them to extend the measuring range both regarding small, four-momentum transfers and isospin decomposition. No show stoppers have been pointed out by the TAC.

Issues: The PAC strongly recommends that the collaboration intensify their cooperation on two issues. (1) Coordinated leadership must be established together with the host laboratory to address the various technical issues connected with the R&D efforts and construction of the K_L beam. (2) Continuous cooperation with JPAC and associated members is recommended for the development of tools to master the challenges connected with the clean extraction of $K\pi$ scattering, the identification of the exchange processes at small momentum transfers, and the amplitude analysis for Δ final states.

Summary: The future K_L facility will add a new physics reach to JLab, and the PAC is looking forward to see the idea being materialized, in conjunction with the plans for Hall D as spelled out in the 2019 White Paper. The collaboration should now devote all its energy to turn this challenging project into an experimental facility and in parallel prepare for a successful data analysis.

This happens because of strong support and dedicated efforts of the KLF Collaboration



New Collaborators from Japan

160 physicists from 68 Universities across 19 countries

Strange Hadron Spectroscopy with Secondary K_L Beam in Hall DExperimental Support:

Shankar Adhikari⁴³, Moskov Amaryan (**Contact Person, Spokesperson**)⁴³, Arshak Asaturyan¹, Alexander Austregesilo⁴⁹, Marouen Baalouch⁸, Mikhail Bashkanov (**Spokesperson**)⁶³, Vitaly Baturin⁴³, Vladimir Berdnikov^{11,35}, Olga Cortes Becerra¹⁹, Timothy Black⁶⁰, Werner Boeglin¹³, William Briscoe¹⁹, William Brooks⁵⁴, Volker Burkert⁴⁹, Eugene Chudakov⁴⁹, Geraint Clash⁶³, Philip Cole³², Volker Crede¹⁴, Donal Day⁶¹, Pavel Degtyarenko⁴⁹, Alexandre Deur⁴⁹, Sean Dobbs (**Spokesperson**)¹⁴, Gail Dodge⁴³, Anatoly Dolgolenko²⁶, Simon Eidelman^{6,41}, Hovanes Egiyan (**JLab Contact Person**)⁴⁹, Denis Epifanov^{6,41}, Paul Eugenio¹⁴, Stuart Fegan⁶³, Alessandra Filippi²⁵, Sergey Furletov⁴⁹, Liping Gan⁶⁰, Franco Garibaldi²⁴, Ashot Gasparian³⁹, Gagik Gavalian⁴⁹, Derek Glazier¹⁸, Colin Gleason²², Vladimir Goryachev²⁶, Lei Guo¹⁴, David Hamilton¹¹, Avetik Hayrapetyan¹⁷, Garth Huber⁵³, Andrew Hurley⁵⁶, Charles Hyde⁴³, Isabella Illari¹⁹, David Ireland¹⁸, Igal Jaegle⁴⁹, Kyungseon Joo⁵⁷, Vanik Kakoyan¹, Grzegorz Kalicy¹¹, Mahmoud Kamel¹³, Christopher Keith⁴⁹, Chan Wook Kim¹⁹, Eberhard Klemp⁵, Geoffrey Krafft⁴⁹, Sebastian Kuhn⁴³, Sergey Kuleshov², Alexander Laptev³³, Ilya Larin^{26,59}, David Lawrence⁴⁹, Daniel Lersch¹⁴, Wenliang Li⁵⁶, Kevin Luckas²⁸, Valery Lyubovitskiy^{50,51,52,54}, David Mack⁴⁹, Michael McCaughan⁴⁹, Mark Manley³⁰, Hrachya Marukyan¹, Vladimir Matveev²⁶, Mihai Mocanu⁶³, Viktor Mokeev⁴⁹, Curtis Meyer⁹, Bryan McKinnon¹⁸, Frank Nerling^{15,16}, Matthew Nicol⁶³, Gabriel Niculescu²⁷, Alexander Ostrovidov¹⁴, Zisis Papandreou⁵³, KiJun Park⁴⁹, Eugene Pasyuk⁴⁹, Peter Pauli¹⁸, Lubomir Pentchev⁴⁹, William Phelps¹⁰, John Price⁷, Jörg Reinhold¹³, James Ritman (**Spokesperson**)^{28,68}, Dimitri Romanov²⁶, Carlos Salgado⁴⁰, Todd Satogata⁴⁹, Susan Schadmand²⁸, Amy Schertz⁵⁶, Axel Schmidt¹⁹, Daniel Sober¹¹, Alexander Somov⁴⁹, Sergei Somov³⁵, Justin Stevens (**Spokesperson**)⁵⁶, Igor Strakovsky (**Spokesperson**)¹⁹, Victor Tarasov²⁶, Simon Taylor⁴⁹, Annika Thiel⁵, Guido Maria Urciuoli²⁴, Holly Szumila-Vance¹⁹, Daniel Watts⁶³, Lawrence Weinstein⁴³, Timothy Whitlatch⁴⁹, Nilanga Wickramaarachchi⁴³, Bogdan Wojtsekhowski⁴⁹, Nicholas Zachariou⁶³, Jonathan Zarling⁵³, Jixie Zhang⁶¹

Theoretical Support:

Alexey Anisovich^{5,44}, Alexei Bazavov³⁸, Rene Bellwied²¹, Veronique Bernard⁴², Gilberto Colangelo³, Aleš Ciepły⁴⁶, Michael Döring¹⁹, Ali Eskanderian¹⁹, Jose Goity^{20,49}, Helmut Haberzettl¹⁹, Mirza Hadžimehmedović⁵⁵, Robert Jaffe³⁶, Boris Kopeliovich⁵⁴, Heinrich Leutwyler³, Maxim Mai¹⁹, Terry Mart⁶⁵, Maxim Matveev⁴⁴, Ulf-G. Meißner^{5,29}, Colin Morningstar⁹, Bachir Moussallam⁴², Kanzo Nakayama⁵⁸, Wolfgang Ochs³⁷, Youngseok Oh³¹, Rifat Omerovic⁵⁵, Hedim Osmanović⁵⁵, Eulogio Oset⁶², Antimo Palano⁶⁴, Jose Peláez³⁴, Alessandro Pilloni^{66,67}, Maxim Polyakov⁴⁸, David Richards⁴⁹, Arkaitz Rodas^{49,56}, Dan-Olof Riska¹², Jacobo Ruiz de Elvira³, Hui-Young Ryu⁴⁵, Elena Santopinto²³, Andrey Sarantsev^{5,44}, Jugoslav Stahov⁵⁵, Alfred Švarc⁴⁷, Adam Szczepaniak^{22,49}, Ronald Workman¹⁹, Bing-Song Zou⁴

6 KLF Personnel

KLF Planning Committee has 39 members (experimental group representatives).

JLab PAC48 approved the KLF experiment for 200 days of running time.

It means that we will run 400 calendar days. So, we must cover 2400 shifts.

The KLF personnel is enough to cover 5 blocks of shifts per KLF Collaboration member for this running time.

For the physics topics discussed in the KLF proposal, 14 institutions have already expressed an intention to contribute to the Hyperon Spectroscopy part

and 7 institutions have expressed an intention to contribute to the Kaon Spectroscopy part,

with 6 institutions intending to contribute to both physics topics.

A detailed distribution of reaction channels to analyzers will be done closer to when data collection begins.

JLAB

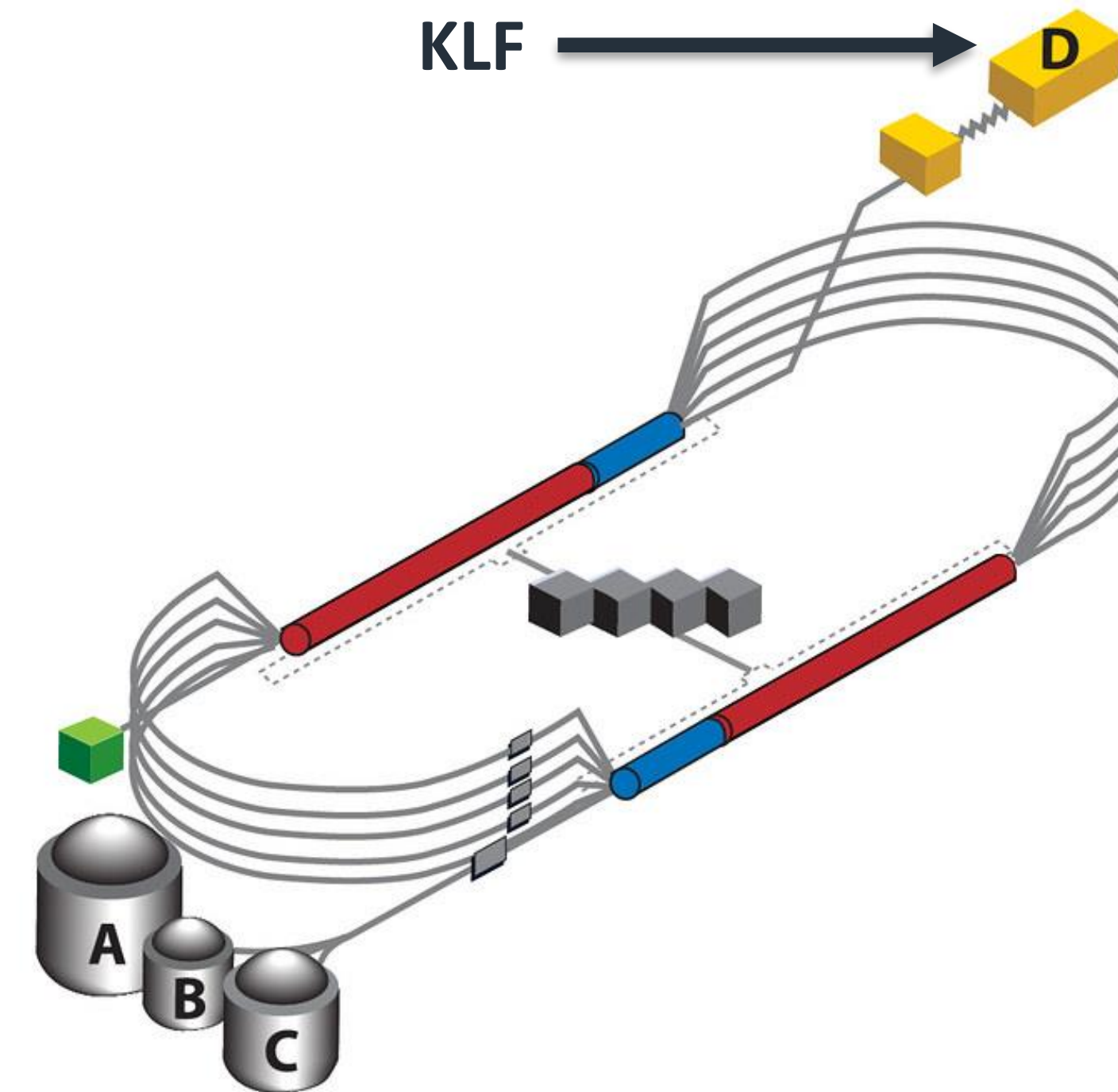

Electron Beam:

- 12 GeV
- $5\mu A$
- 128ns bunch spacing

Hall-D beamline and GlueX Setup

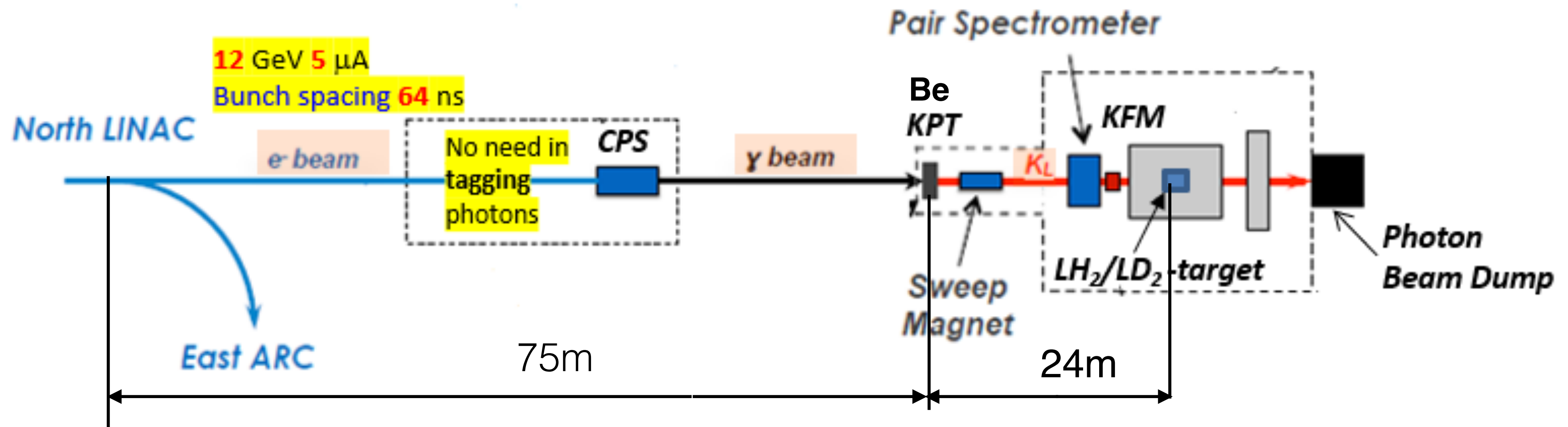

<https://arxiv.org/pdf/2008.08215.pdf>

K_L Beam Flux

JLab 12 GeV

SLAC 16 GeV

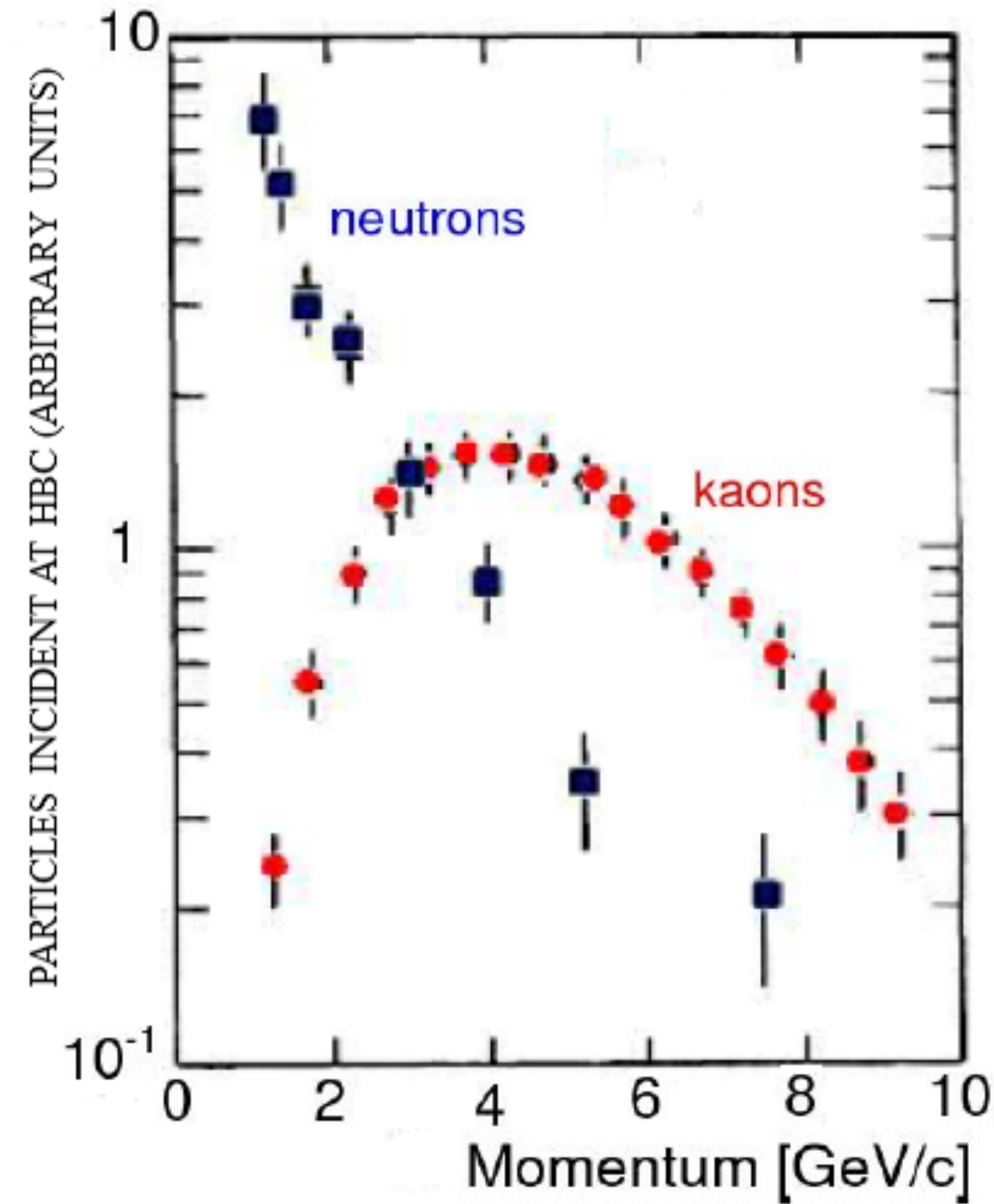
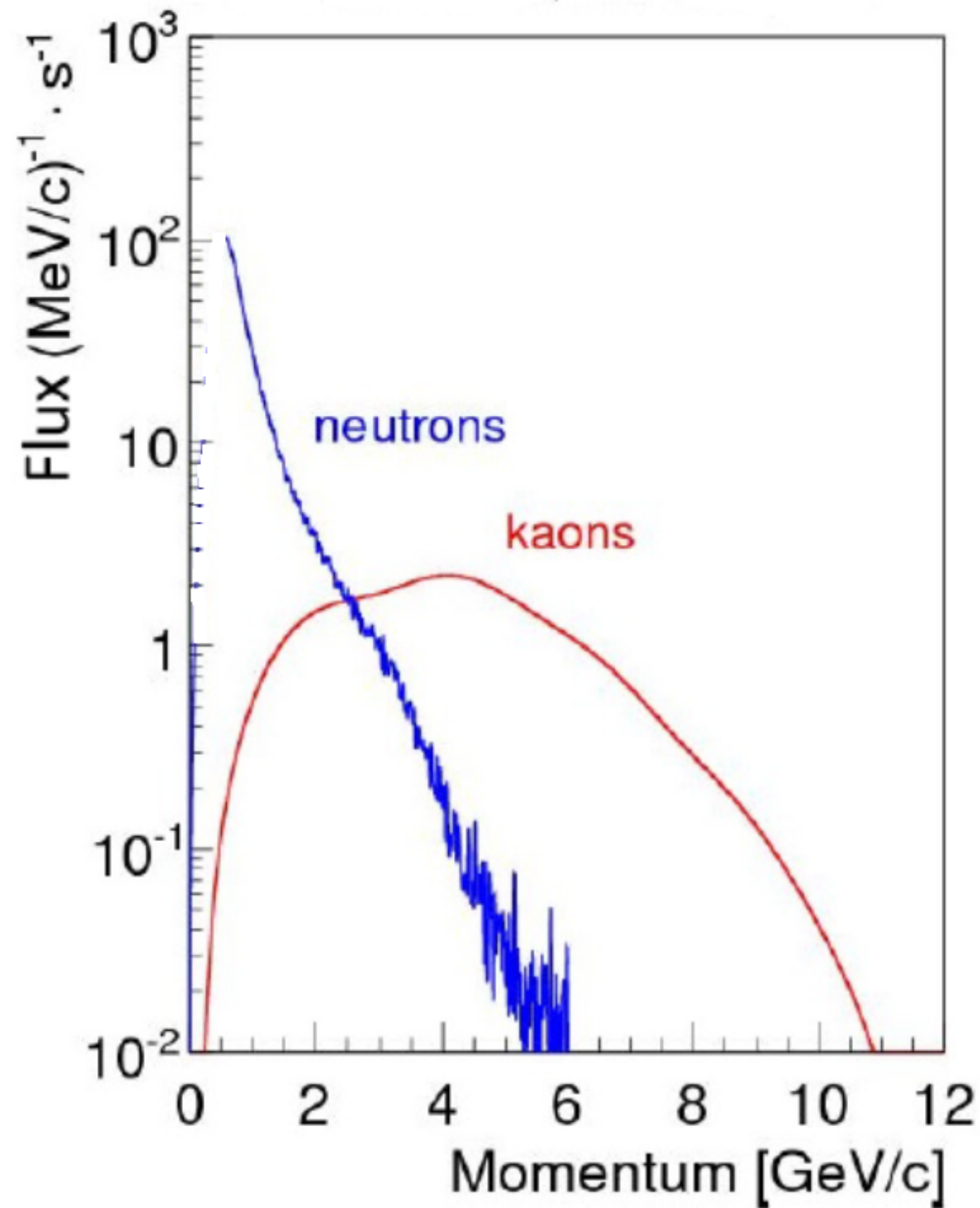

$$N(K_L)/sec \sim 10^4$$

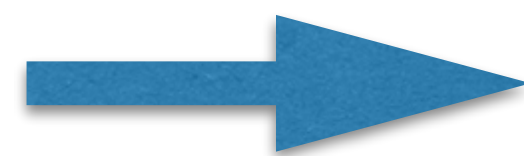

$$\frac{N(K_L)_{JLAB}}{N(K_L)_{SLAC}} \sim 10^3$$

Hyperon Spectroscopy

LQCD in addition to already known states

predicts many more including hybrids (thick bordered)

8-states

5-states

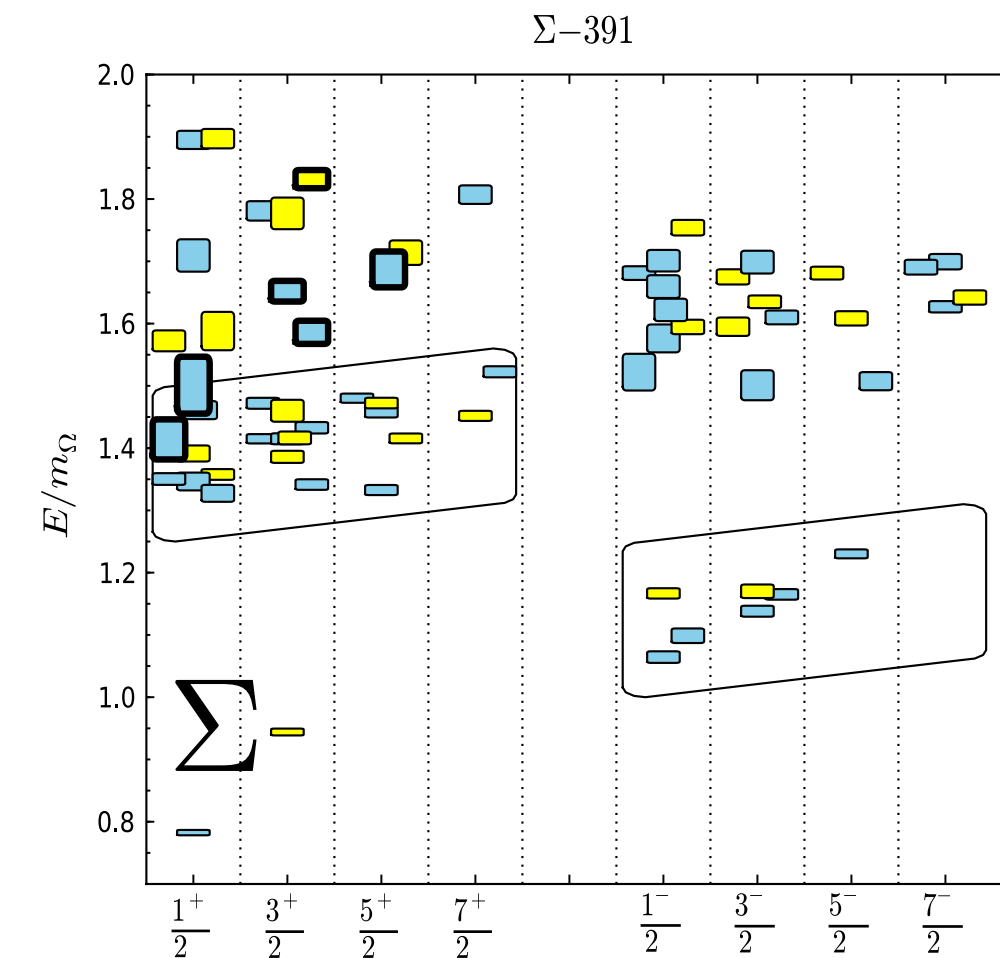
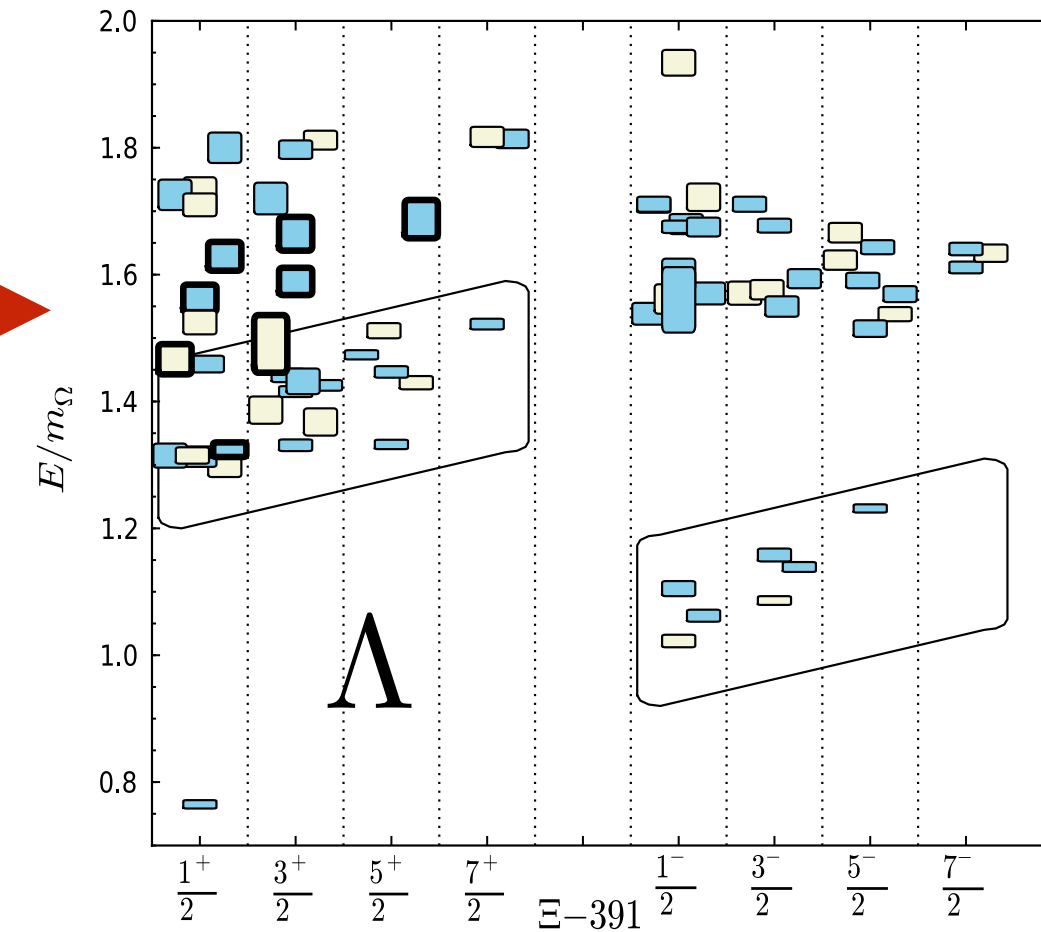

6-states

4-states

3-states

4-states

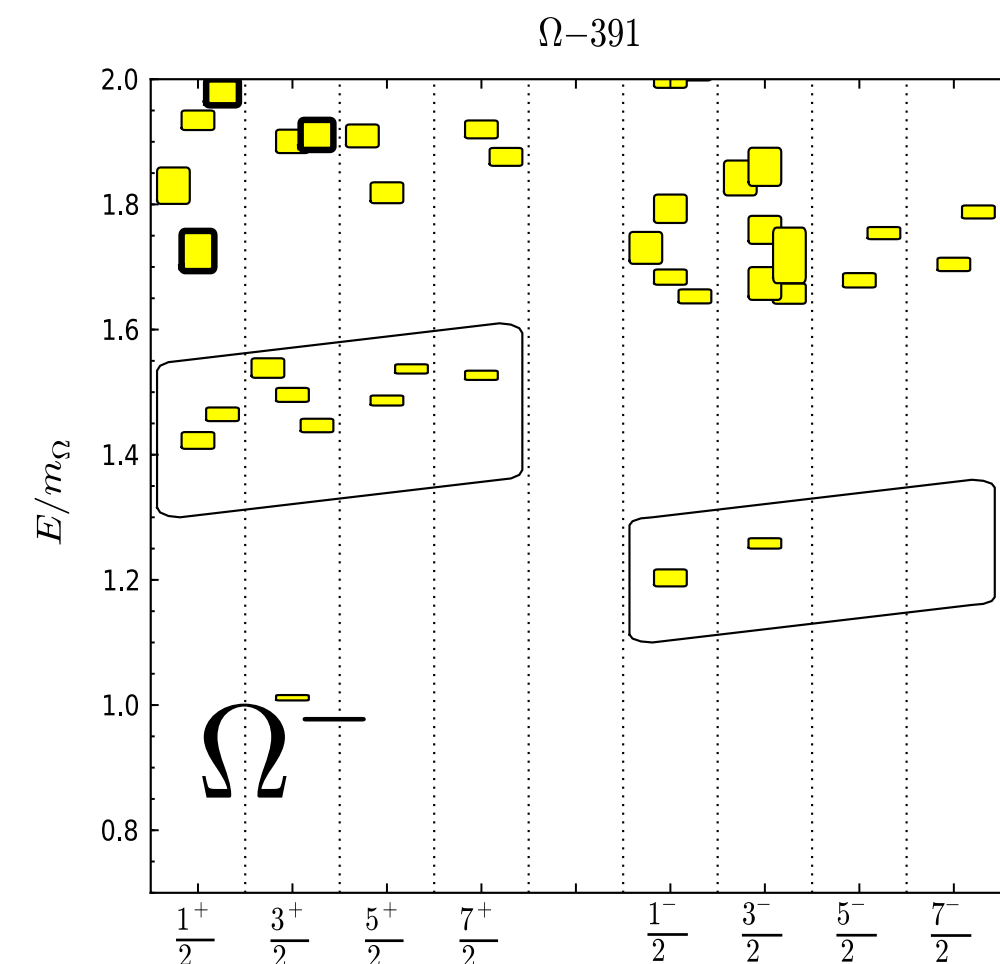
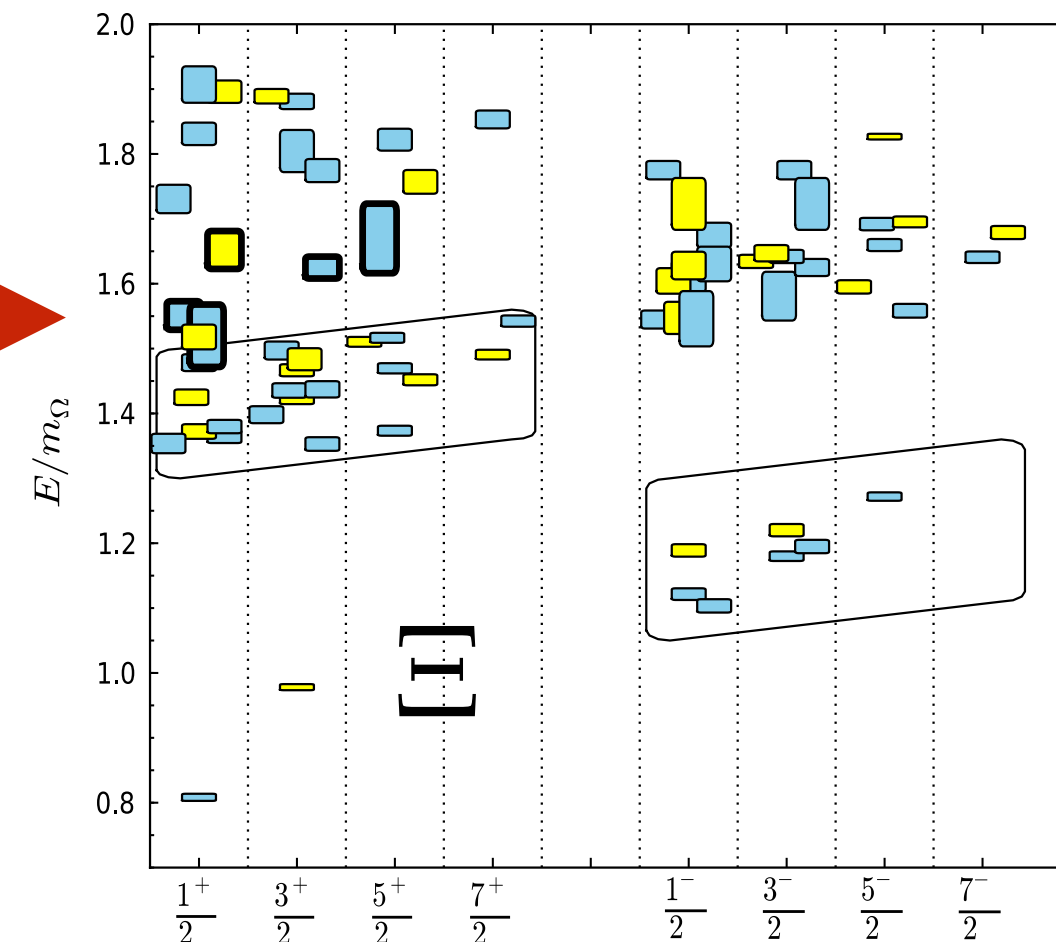

1-state

1-state

Edwards, Mathur, Richards and Wallace, *Phys. Rev. D* 87, 054506 (2013)

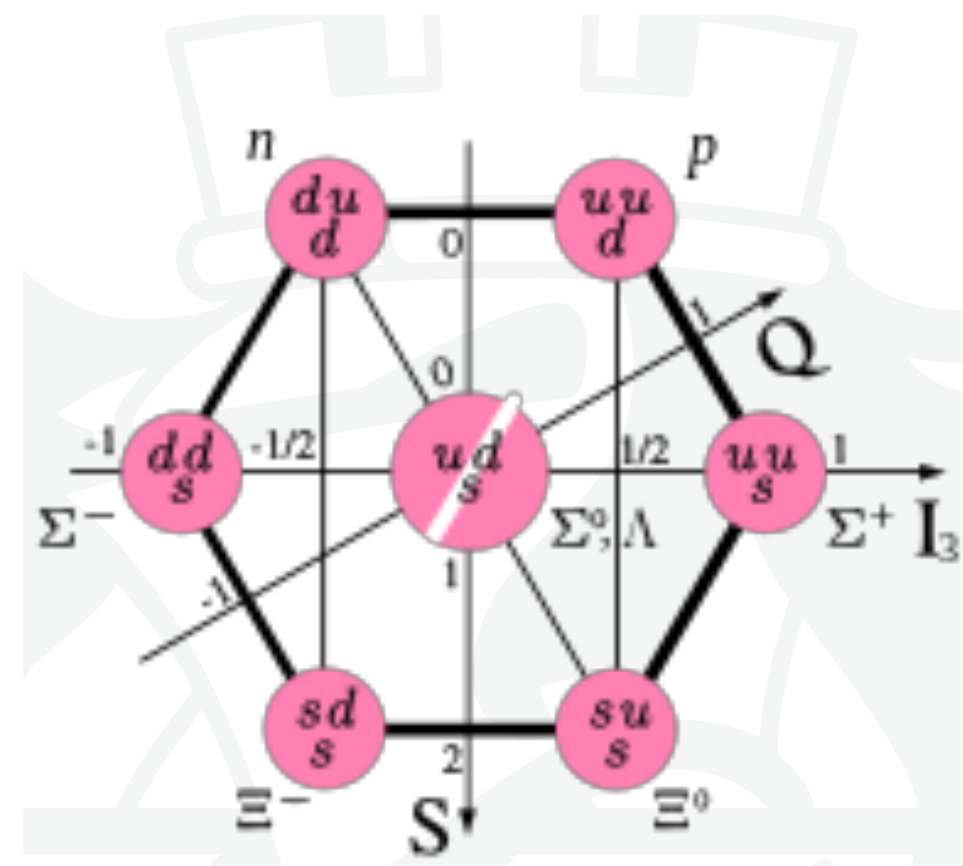

Octet: N^* , Λ^* , Σ^* , Ξ^*
 Decuplet: Δ^* , Σ^* , Ξ^* , Ω^*

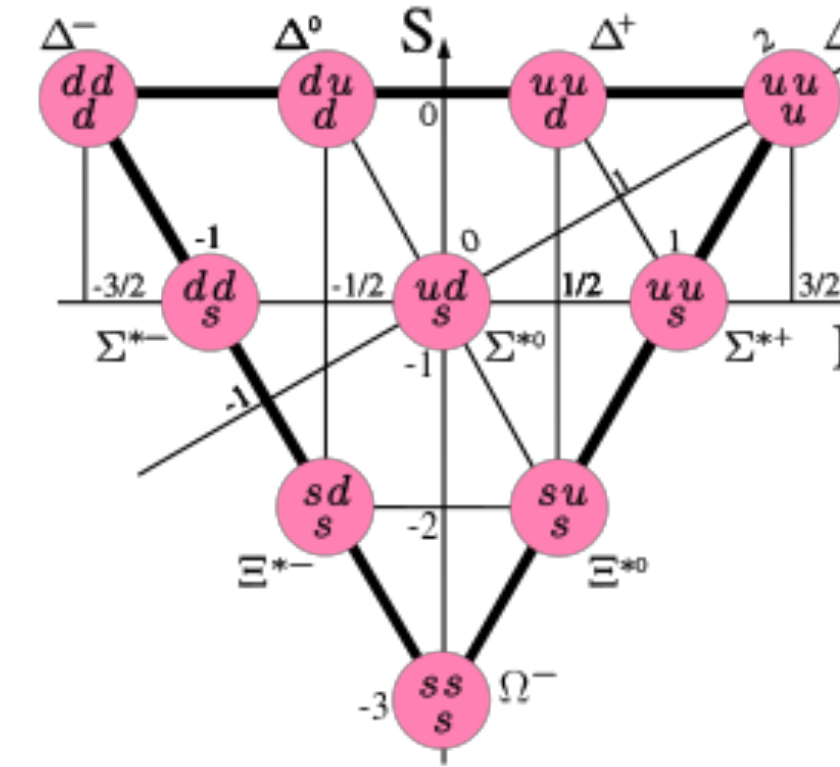

	Predicted LQCD, $M_B < 2.5 \text{ GeV}$	"Observed", PDG
N^*	64	21
Δ^*	22	12
Λ^*	17	14
Σ^*	43	9
Ξ^*	42	6
Ω^*	24	2

212

64

Electron Beam Parameters

$$E_e = 12 \text{ GeV} \quad I = 5 \mu\text{A}$$

$$\text{Bunch spacing} \quad 64 \text{ ns}$$

128 ns confirmed feasible

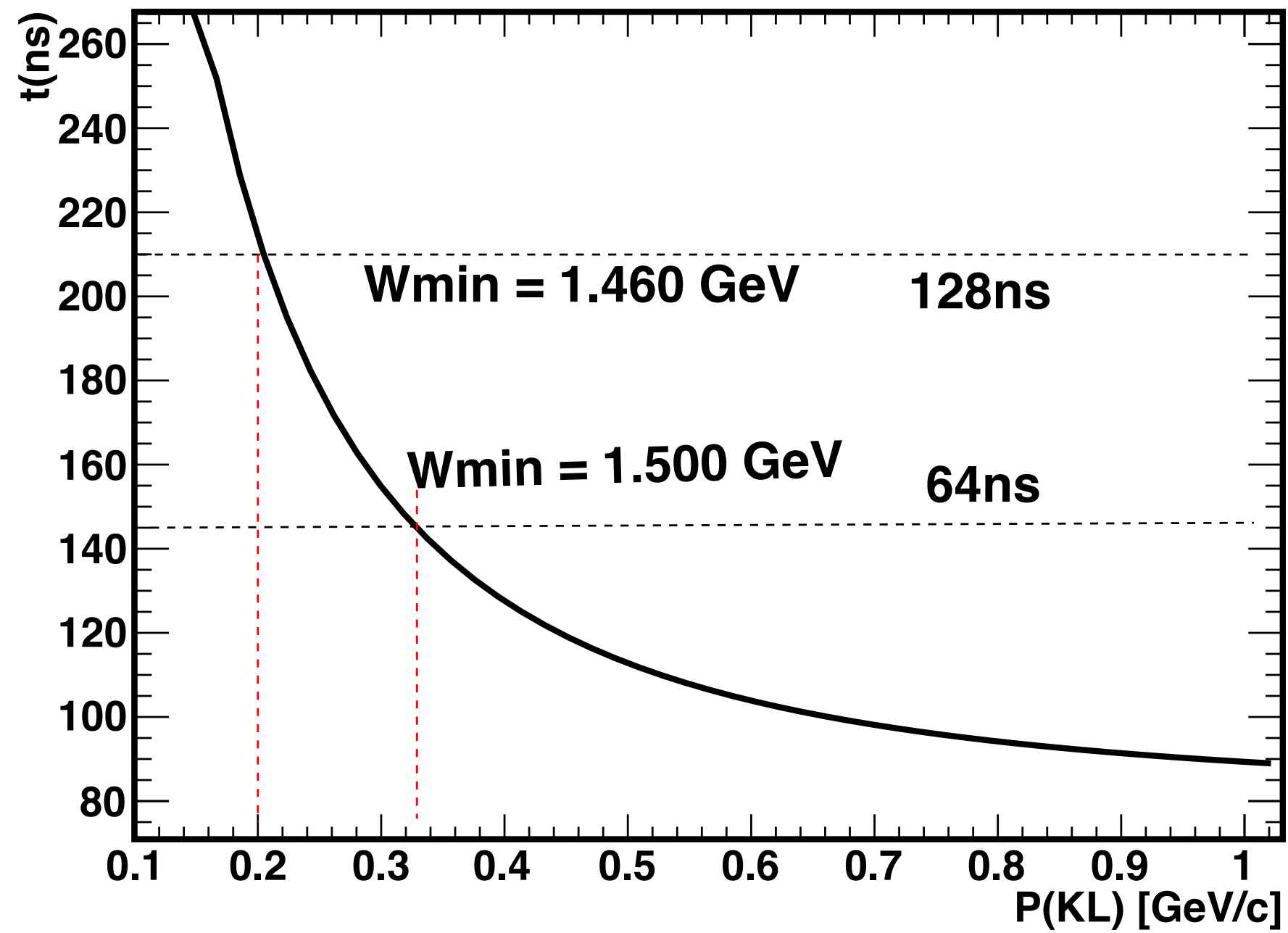

K+N Elastic Scatterings for Estimation of the In-Medium Quark Condensate with Strange Quarks

Yutaro Iizawa (Tokyo Inst. Tech.), Daisuke Jido (Tokyo Inst. Tech.),

Stephan Hübbsch (Tokyo Inst. Tech.) (Aug 18, 2023)

Published in: *PTEP* 2024 (2024) 5, 053D01

• e-Print: [2308.09397](https://arxiv.org/abs/2308.09397) [hep-ph]

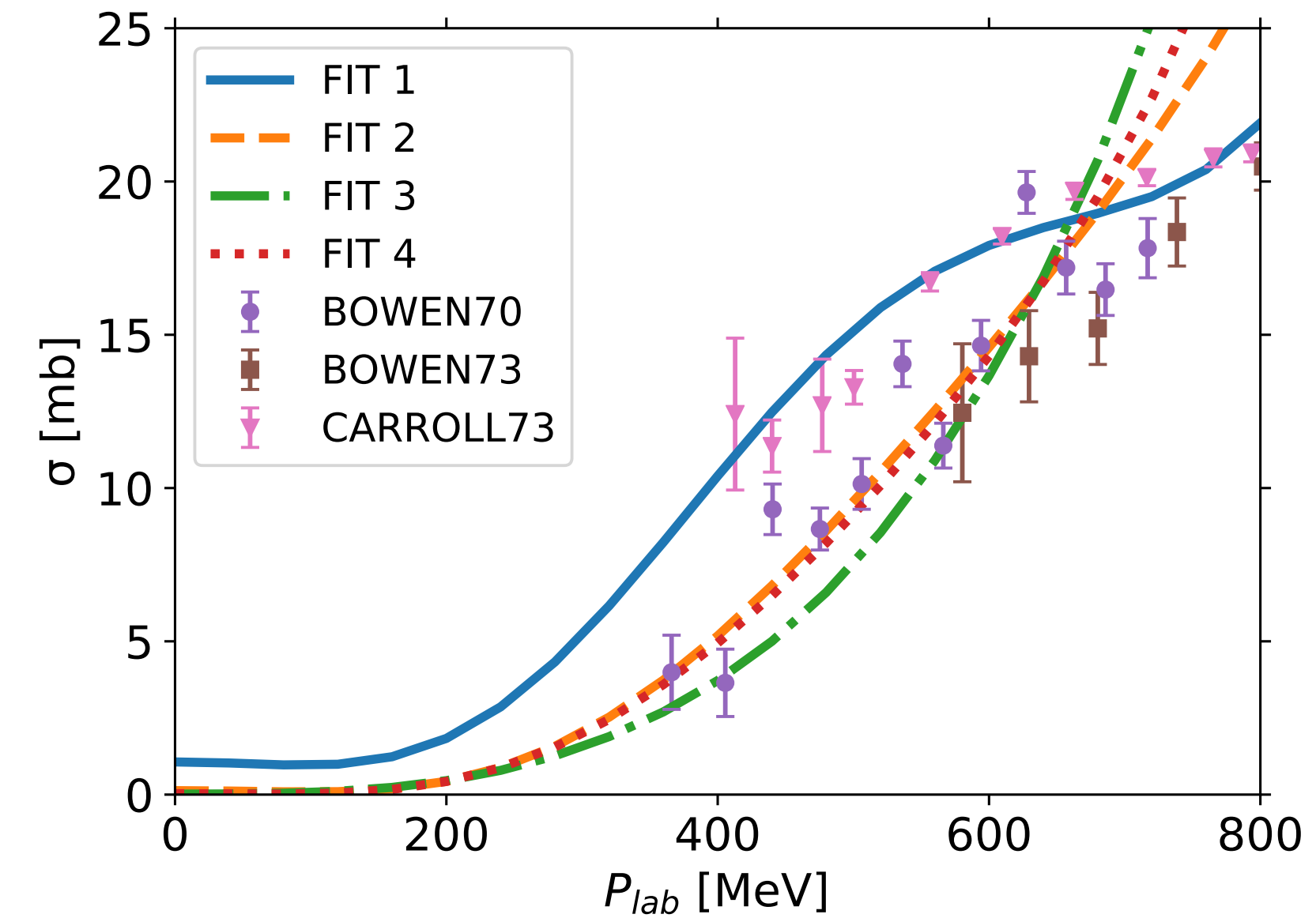

Fig. 3: $I = 0$ K^+N total cross sections calculated with the determined LECs given in Table. 3 in comparison with the experimental data [32, 39, 41].

More in a talk of V. Baturin

Proposed Measurements

SLAC

$$K^- \pi^+ \rightarrow K^- \pi^+$$

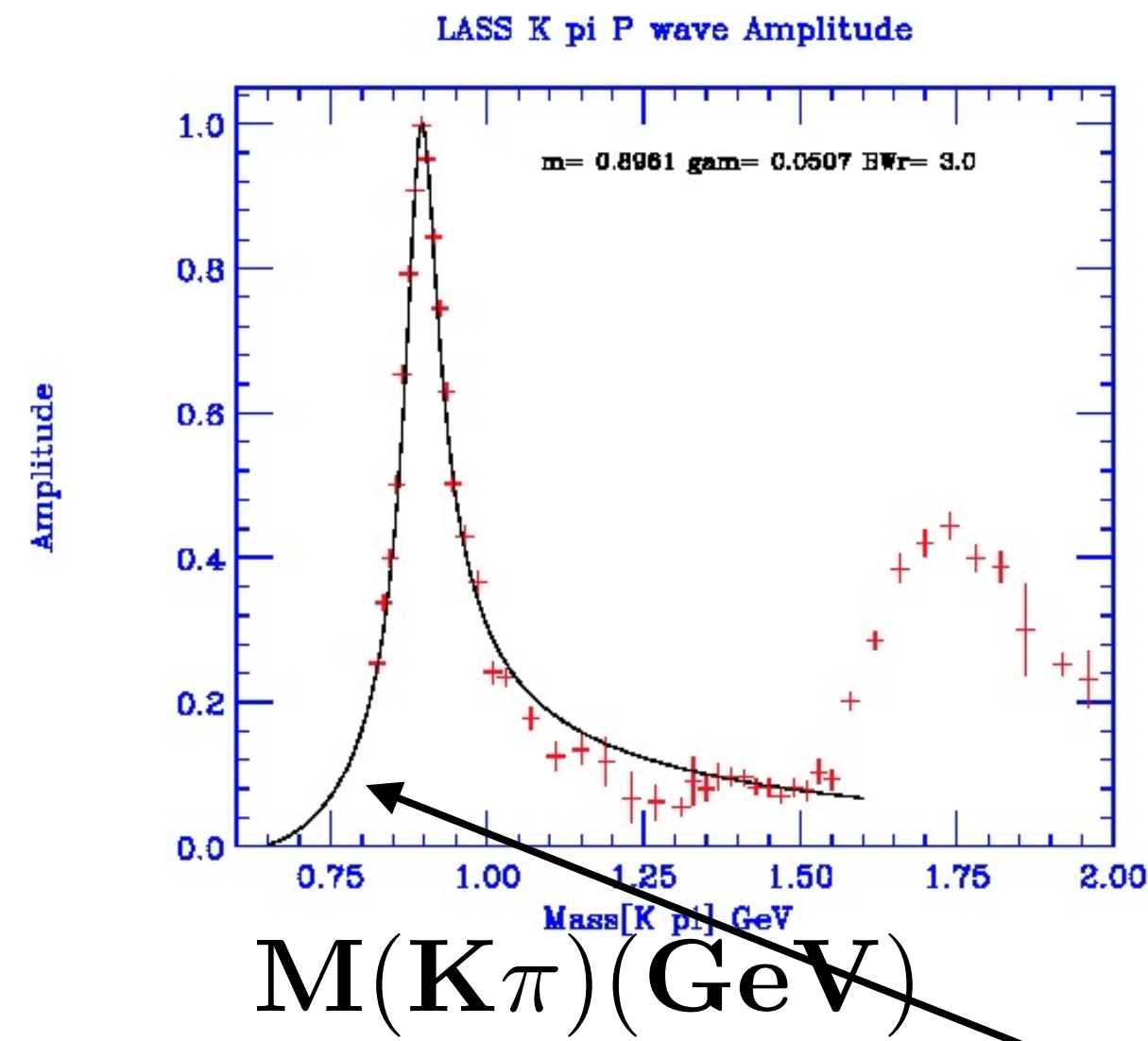

Belle

$$\tau \rightarrow K \pi \nu_\tau$$

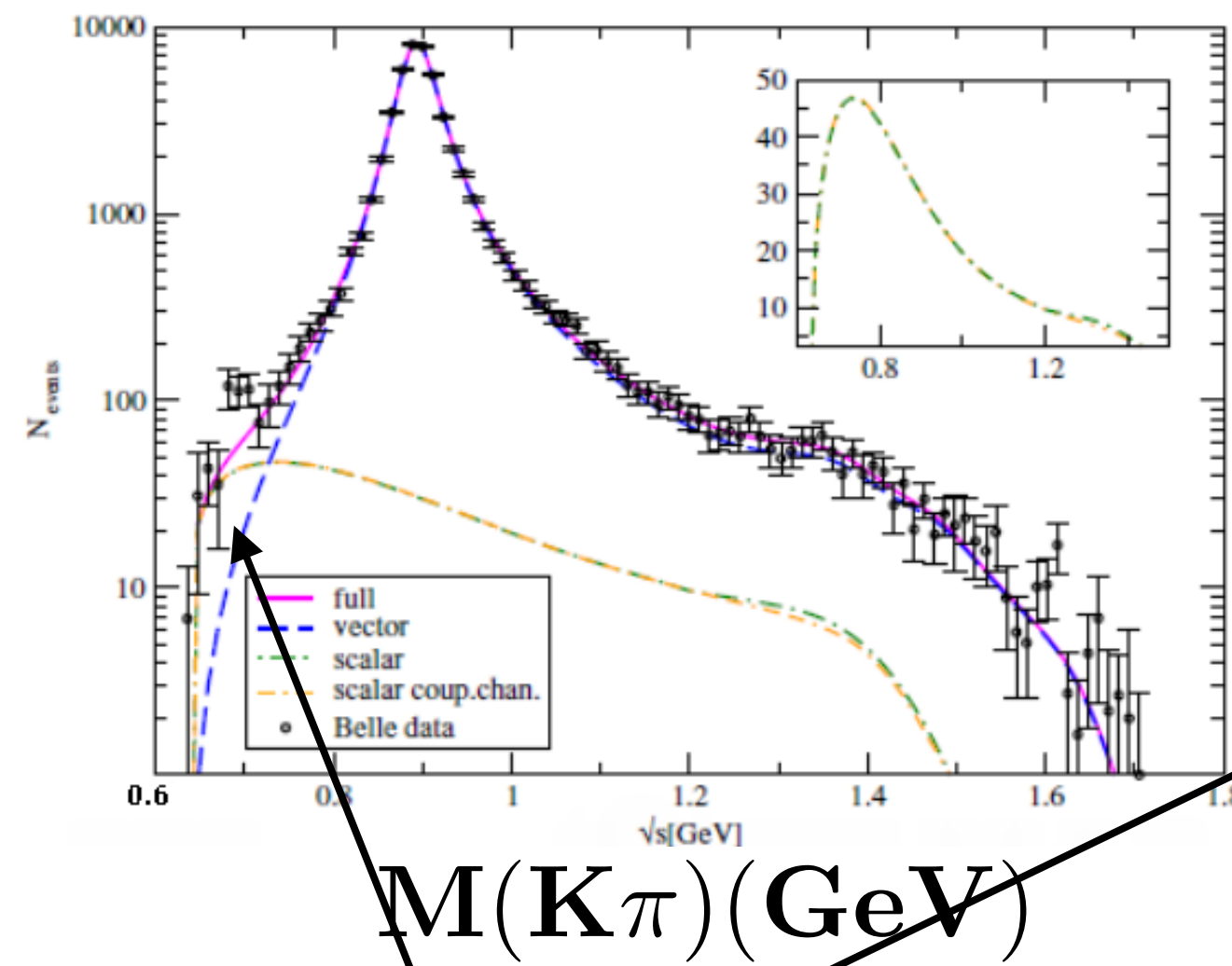

KLF

$$K_L \pi^0 \rightarrow K^+ \pi^-$$

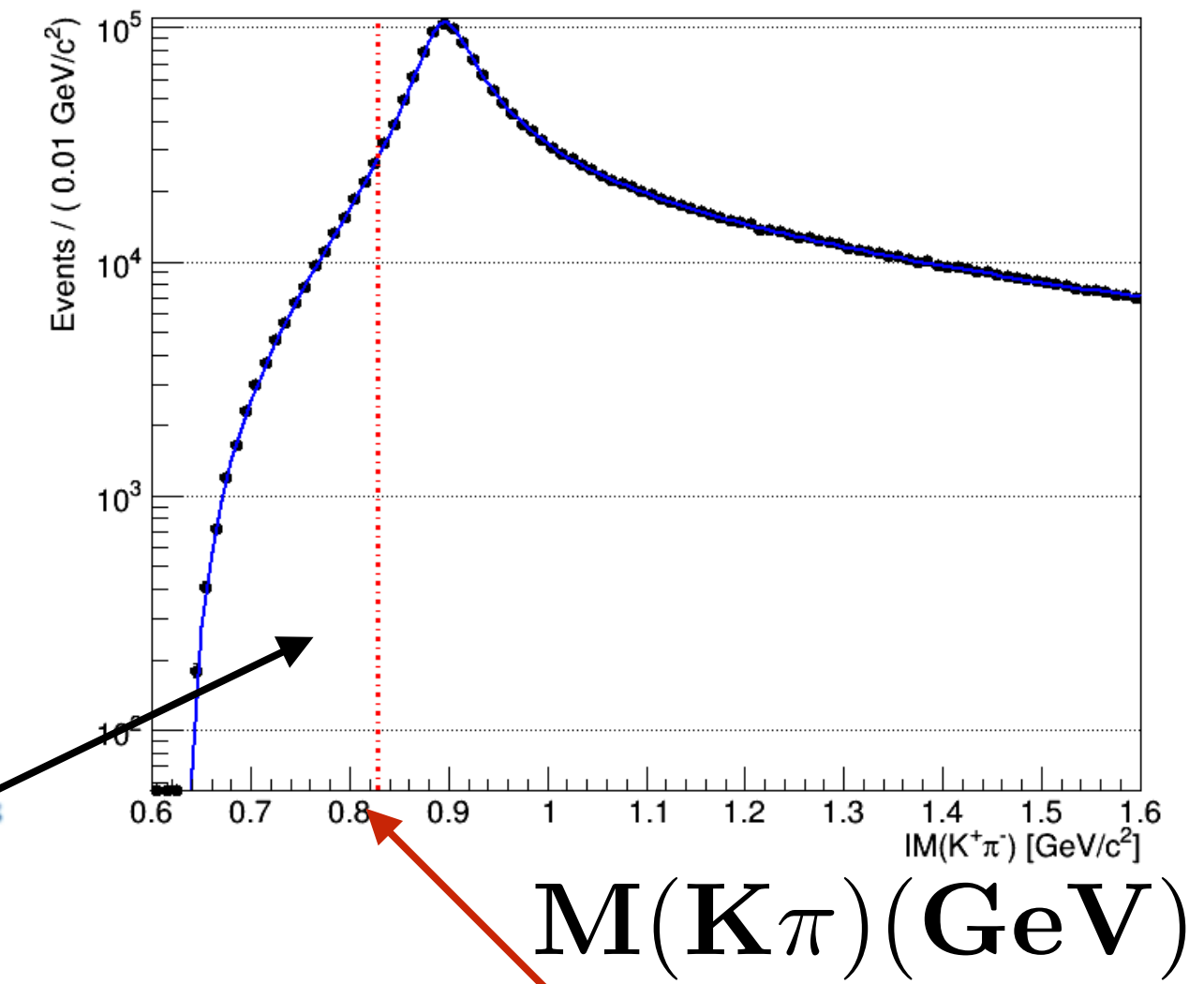

region of κ

SLAC Lower limit

Scalar Meson Nonet

$$J^{PC} = 0^{++}$$

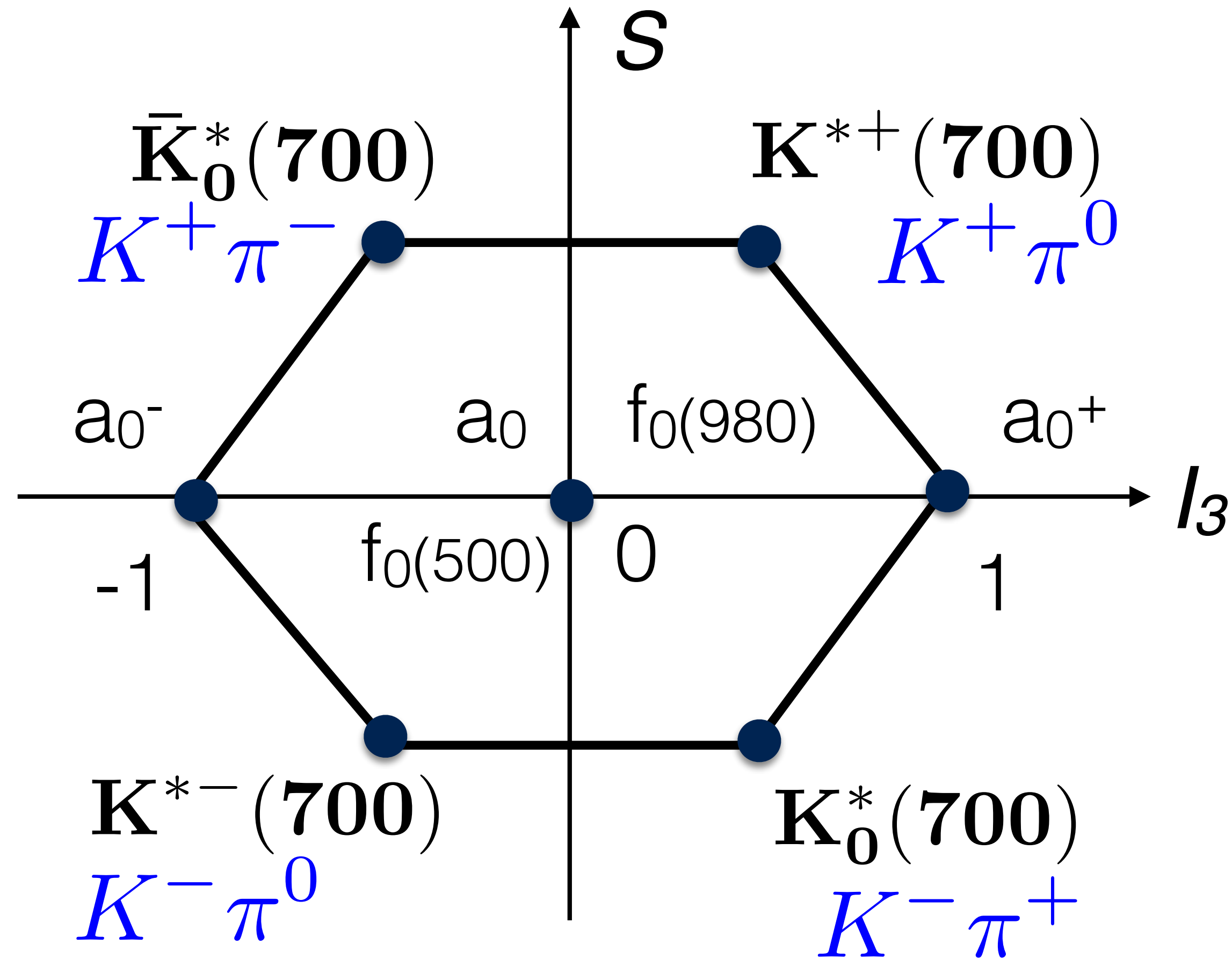

Four states called κ

still need further confirmation(PDG)

Kappa Mass and Width

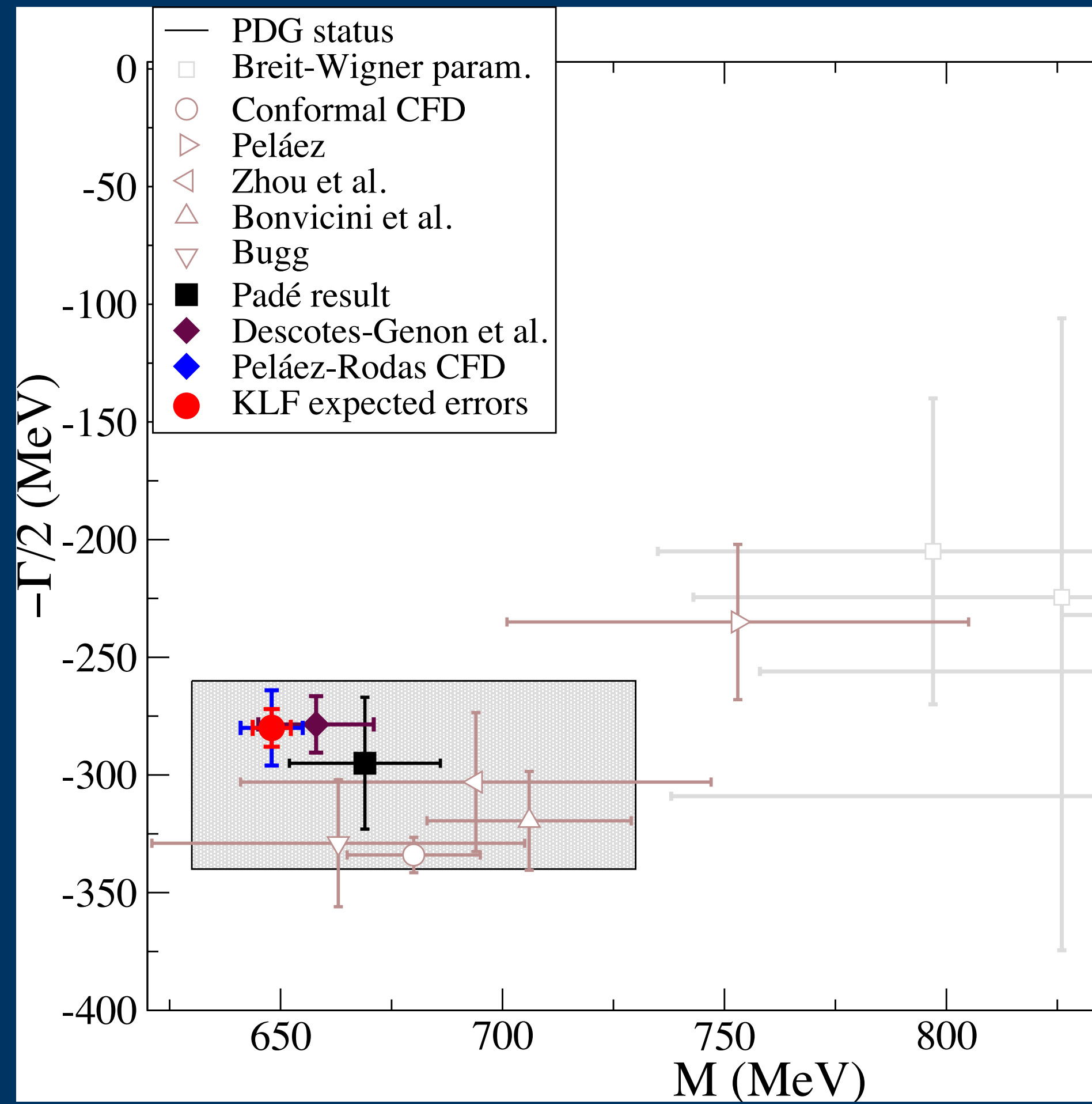
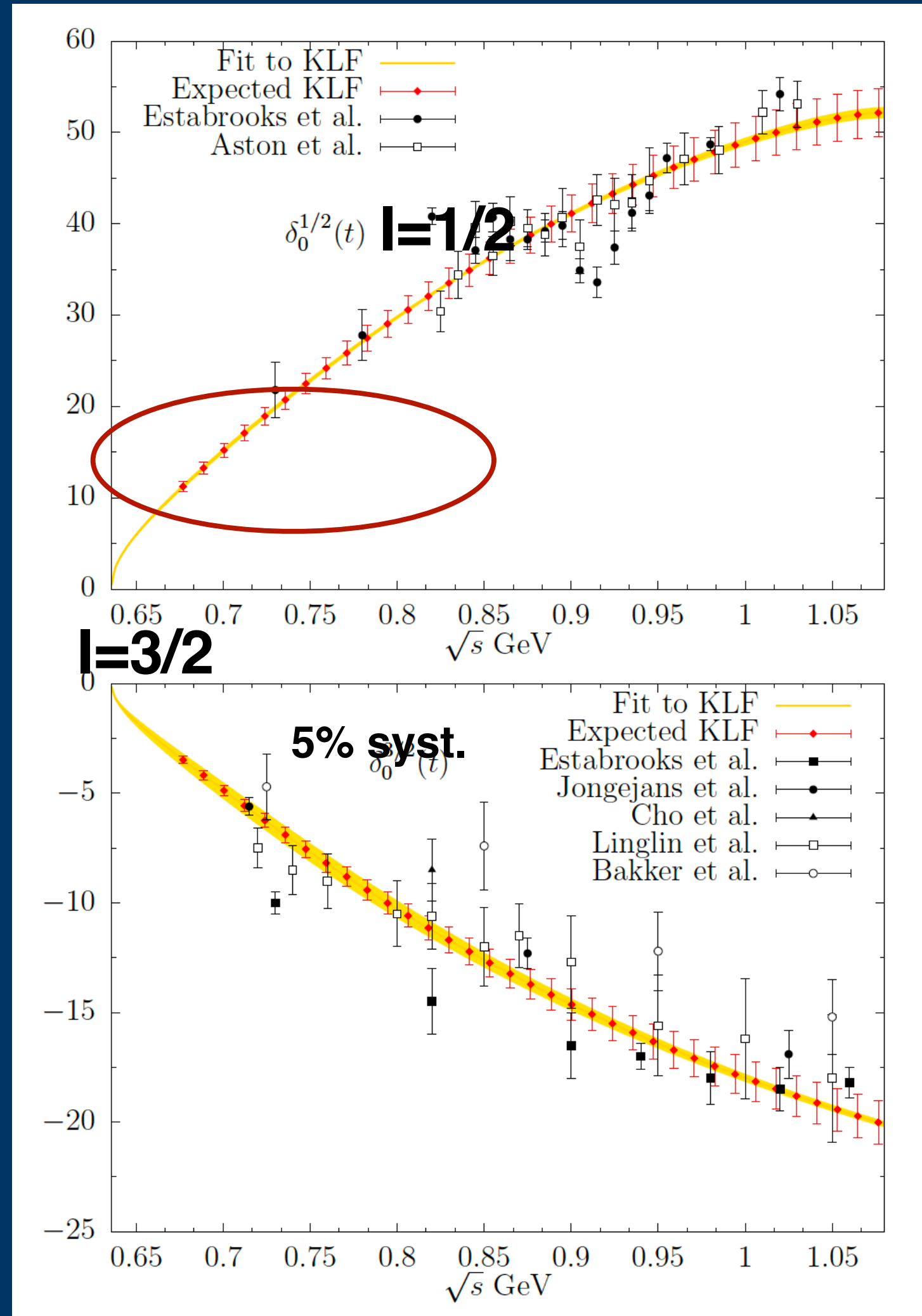

S wave phase shift, $I = 1/2$ and $I = 3/2$ with statistical and systematic uncertainties.

Roy-Steiner dispersion approach

J.R. Pelaez and et.al. Phys. Rev. D 93, 074025

$$\sqrt{s_\kappa} \equiv M - i\Gamma/2 = 648 \pm 4 - i280 \pm 8 \text{ MeV}$$

More data points are added close to threshold from KLF.

Summary of $K\pi$ Scattering

- The KLF will have a significant impact on our knowledge on $K\pi$ scattering amplitudes
- It will improve on still conflictive determination of heavy K^* 's parameters
- It will help to settle the tension between phenomenological determinations of scattering lengths from data versus ChPT and LQCD
- Finally, and very importantly, it will **reduce the uncertainty in the mass determination of $K^*(700)$ and by more than a factor of two and by factor of five the uncertainty on its width**
- It will further clarify debates of **its existence**, and therefore a long standing problem of the **existence of the scalar meson nonet**

Formation of Visible Matter during the Freeze-Out of the Universe after the Big Bang

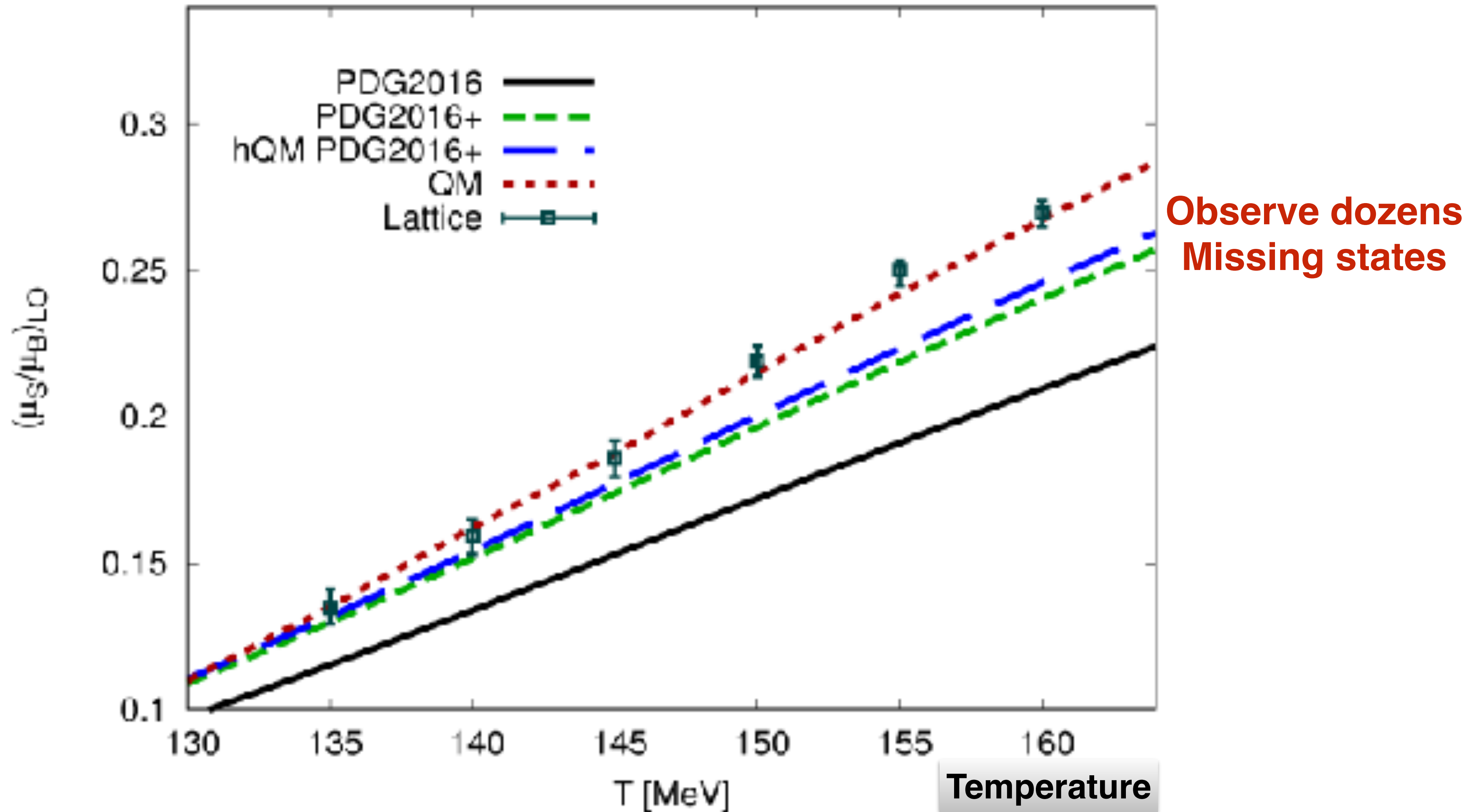

SUMMARY

- **-Proposed KL Facility has a unique capability to improve existing world database up to three orders of magnitude**
- **-In Hyperon spectroscopy**
PWA will allow to unravel and measure pole positions and widths of a **few dozens** of new excited states
- **-In Strange Meson Spectroscopy**
PWA will allow to measure excited K^* states
- **To accomplish physics program 200 days running is approved**
- **All components of KL Facility considered are feasible**
-With total cost of the project below 2M

Thanks for your attention!