

The PRad-II Flash ADC-based Upgraded DAQ.

Dipangkar Dutta

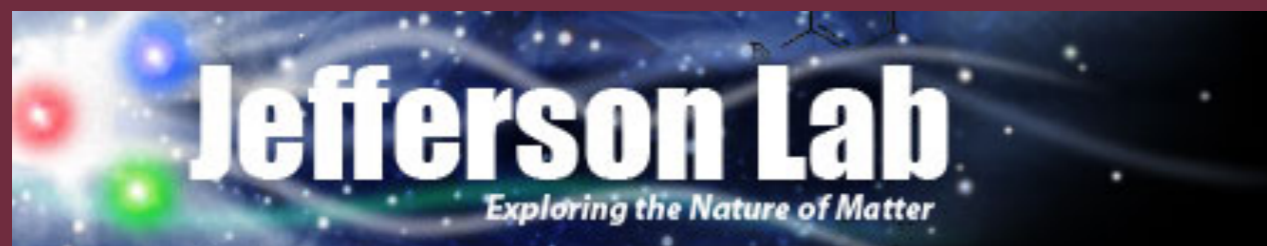

for the
PRad collaboration

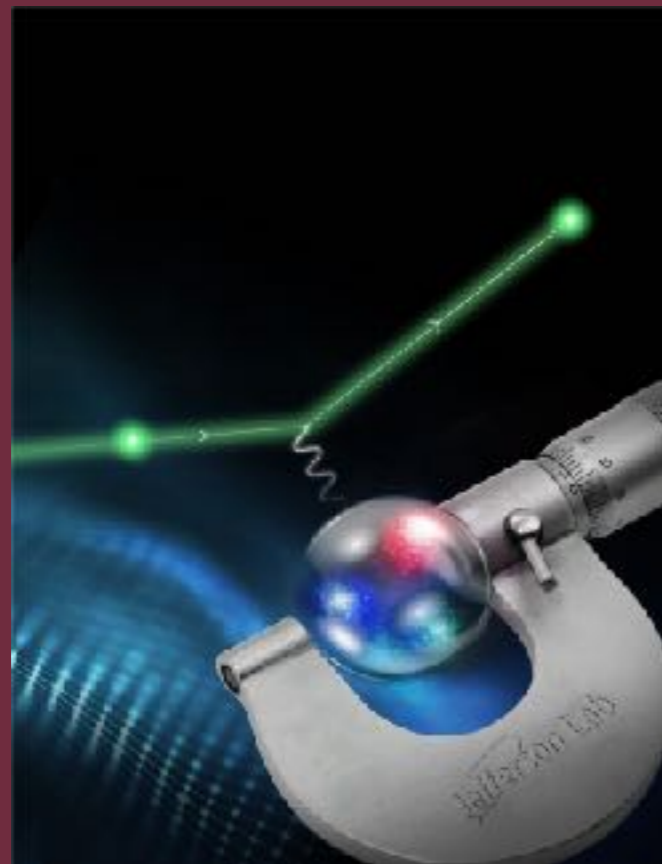

PRad-II Technical Review

March 12, 2021

PRad used a FASTBUS-based DAQ

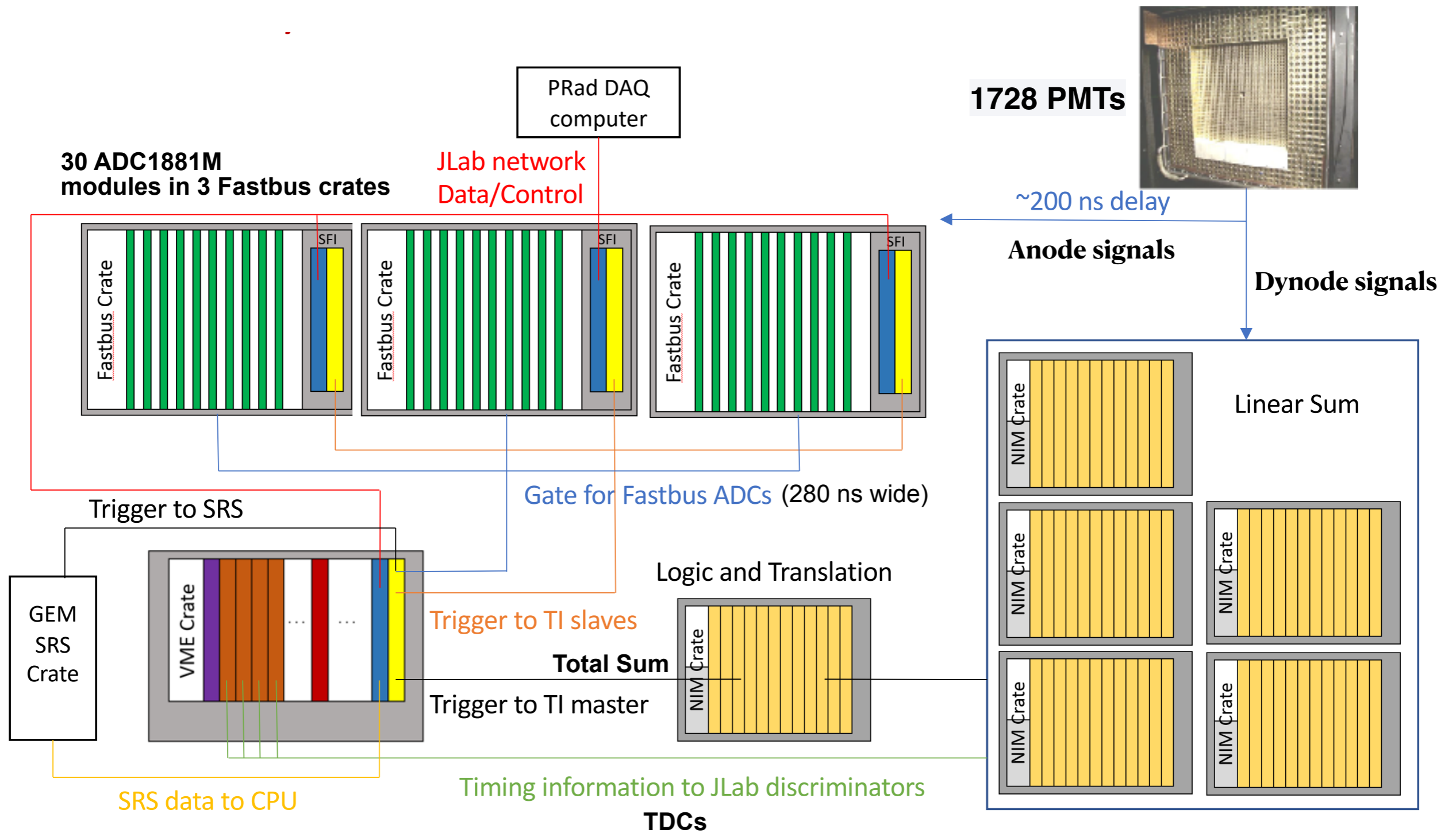

**A FASTBUS-based DAQ with custom summing modules and TDCs
DAQ rate ~ 4 kHz & 80-90% live-time during production.**

Image courtesy of Chao Peng

PRad used custom summing modules

Dynode signals from all PMTs summed by 52 UVA120A custom linear summing modules

1 copy of output digitized using 52 CAEN v1990 TDC modules

2nd copy summed using NIM Fan-In modules to produce the Total Sum Trigger

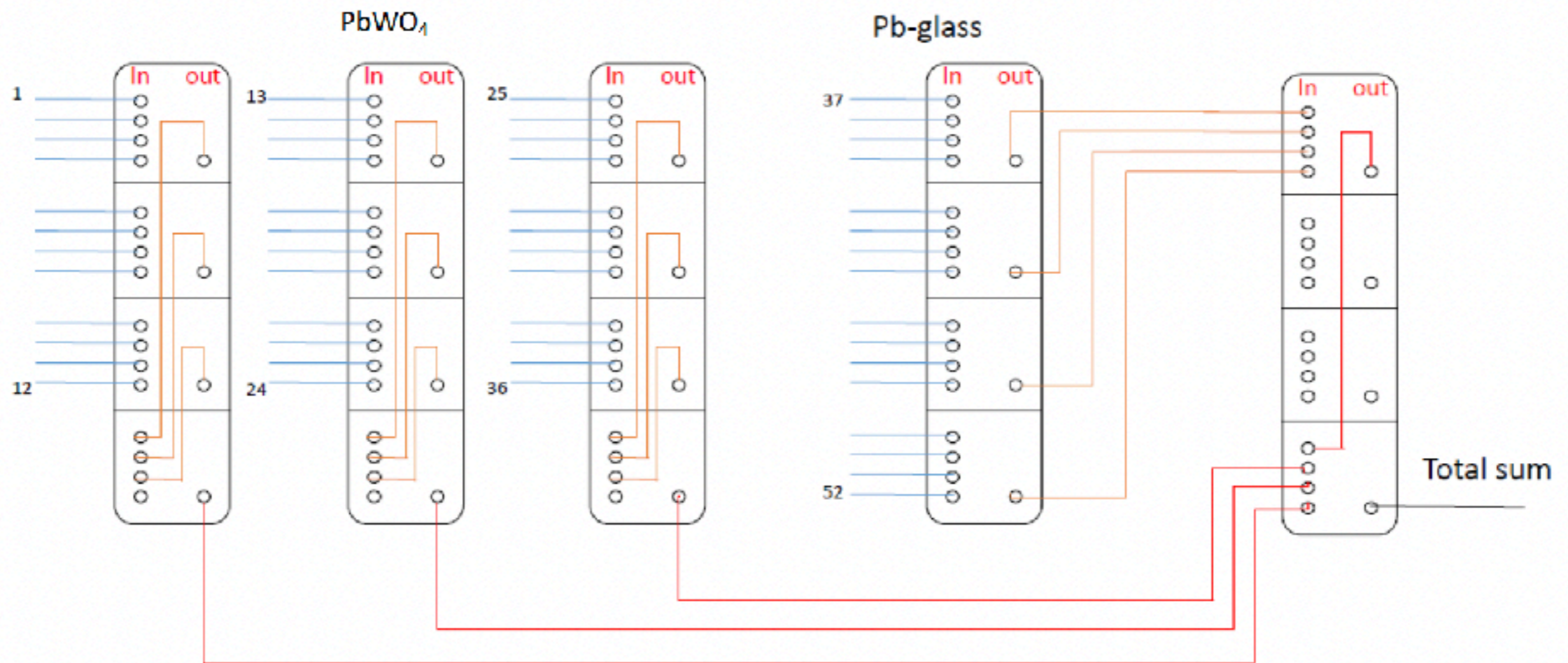

A FASTBUS-based DAQ with custom summing modules and TDCs
DAQ rate ~ 4 kHz

Image courtesy of Chao Peng

PRad-II will upgrade to a FADC-based DAQ

Conceptual setup

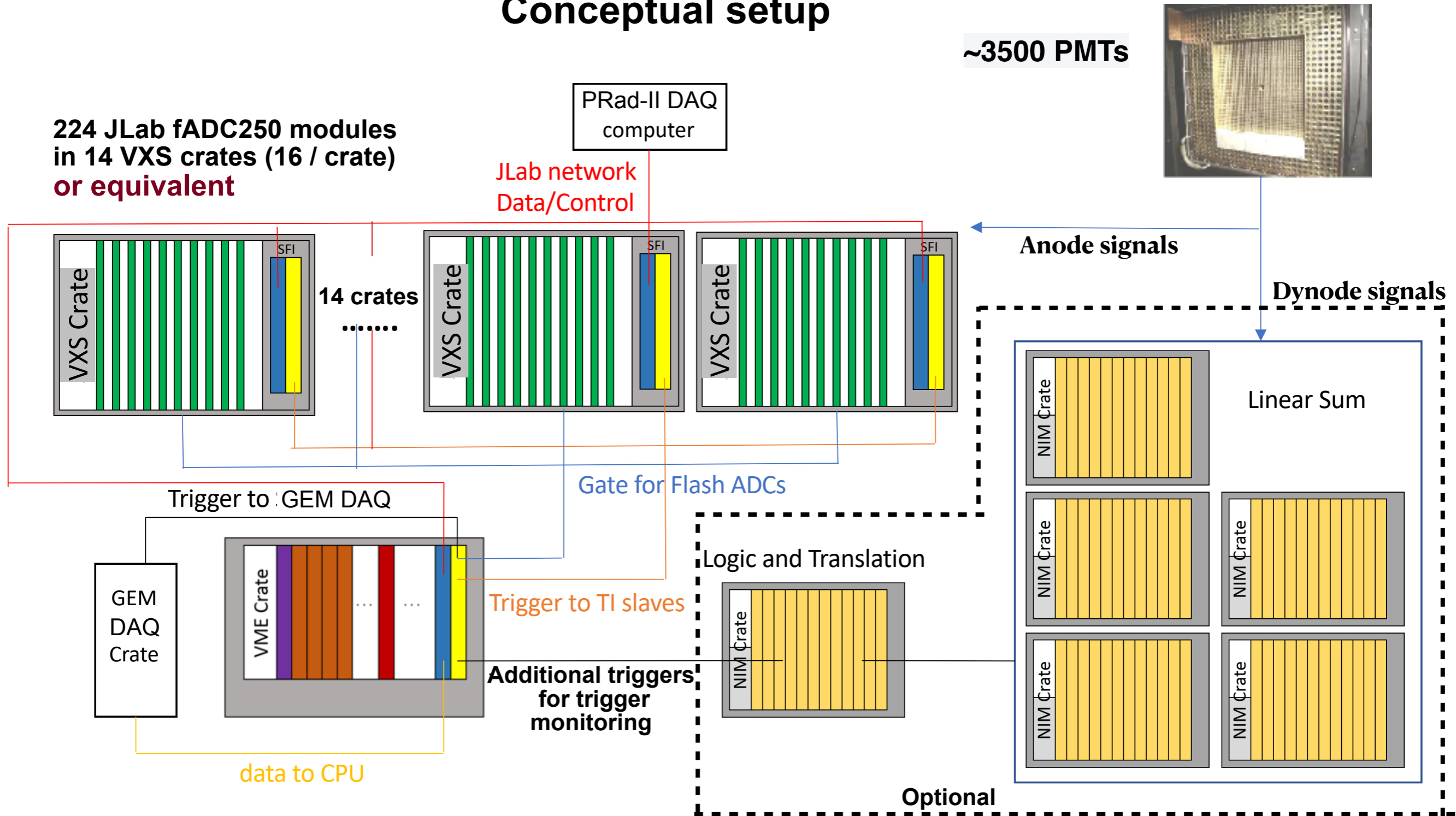

Modern flash ADC-based pipelined DAQ with robust trigger efficiency monitoring

Image courtesy of Chao Peng

There are several key advantages to the FADC-based DAQ

Advantages of a modern flash ADC-based pipelined DAQ



Eliminates the need for 100s of meters of delay cables

Better gain and pedestal stability and monitoring

Essentially dead time free

Improved rejection of accidentals

Improved trigger efficiency with continuous monitoring (with “random” trigger)

Provides timing information for each crystal with better than 1.5 ns resolution, needed for the veto scintillators enabling access to the lowest Q^2 in e-p scattering experiments.

7 fold improvement in DAQ rate

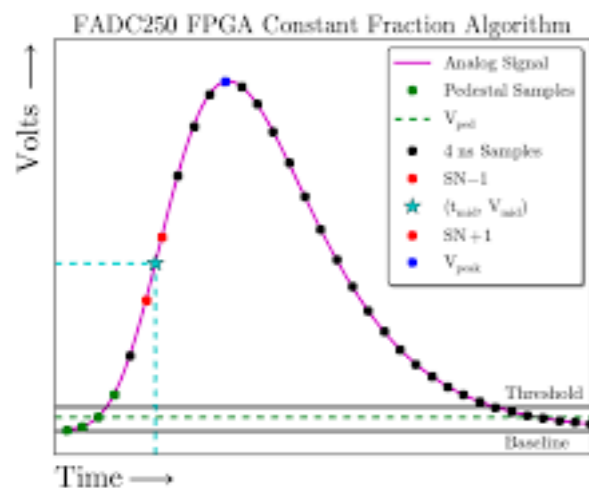
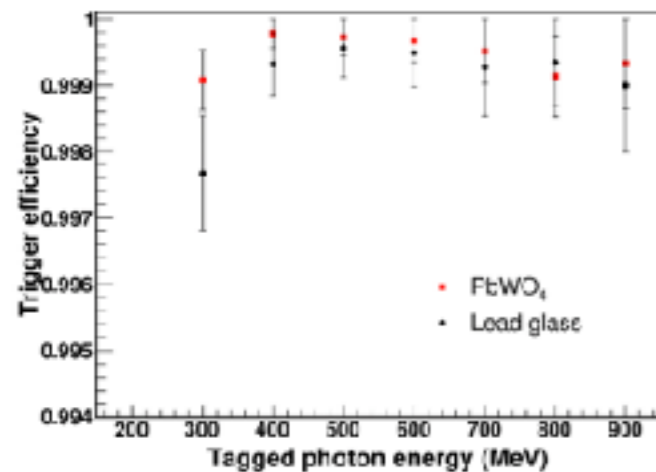
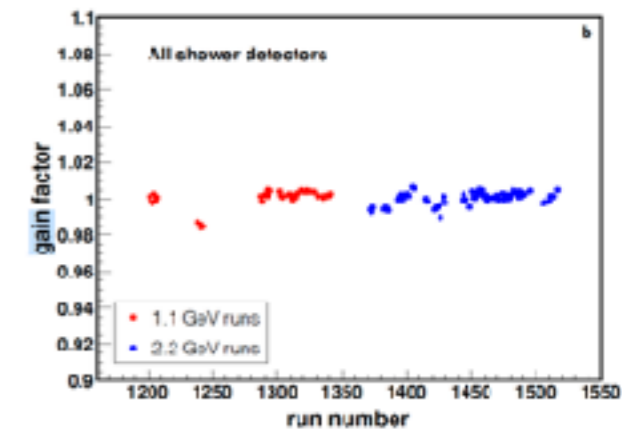

Images courtesy of Weizhi Xiong

The upgraded DAQ enables 7-fold improved rate

Critical for the factor of ~ 4 reduction in the statistical uncertainty of PRad-II

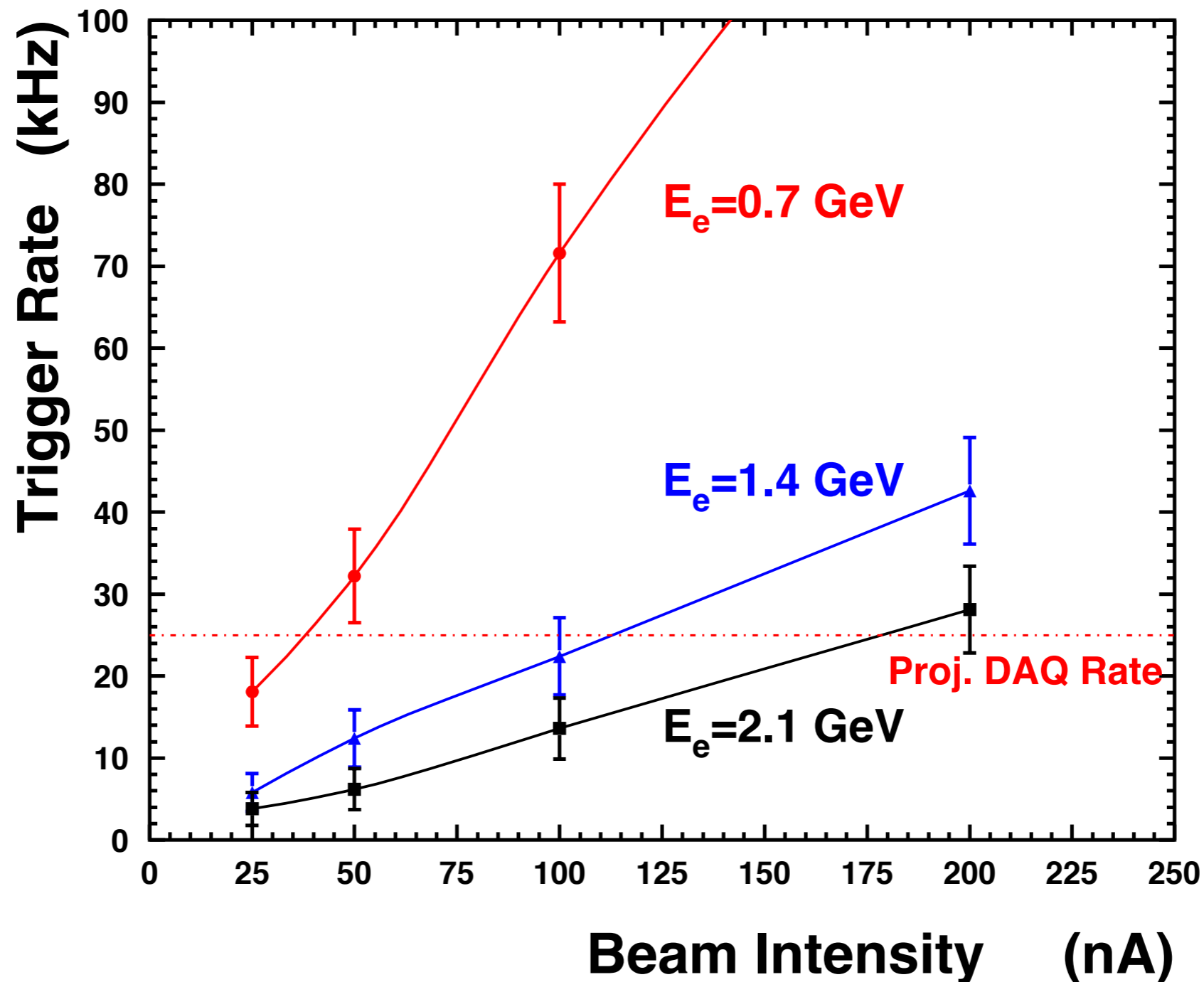

DAQ Hardware related resources were requested in the NSF pre-proposal

Qty	Description	cost		Notes
1	VXS crate	\$16,000	\$16,000	Includes high current supply and high RPM fans
16	FADC250	\$6,000	\$96,000	16 boards per crate (256 channel total) Lemo inputs
1	SD	\$2,000	\$2,000	Signal distribution board
1	VTP	\$9,000	\$9,000	Trigger processor
1	TI	\$1,500	\$1,500	Trigger interface
1	CPU	\$5,500	\$5,500	Linux readout controller
		Total:	\$130,000	

14 crates + 1 spare : $\$130,000 \times 15 = \1.95 Million