

HKS DAQ meeting

Graduate School of Science, Kyoto University

Toshiyuki Gogami

Nov 4, 2023



京都大学 理学研究科・理学部
GRADUATE SCHOOL OF SCIENCE
FACULTY OF SCIENCE
KYOTO UNIVERSITY

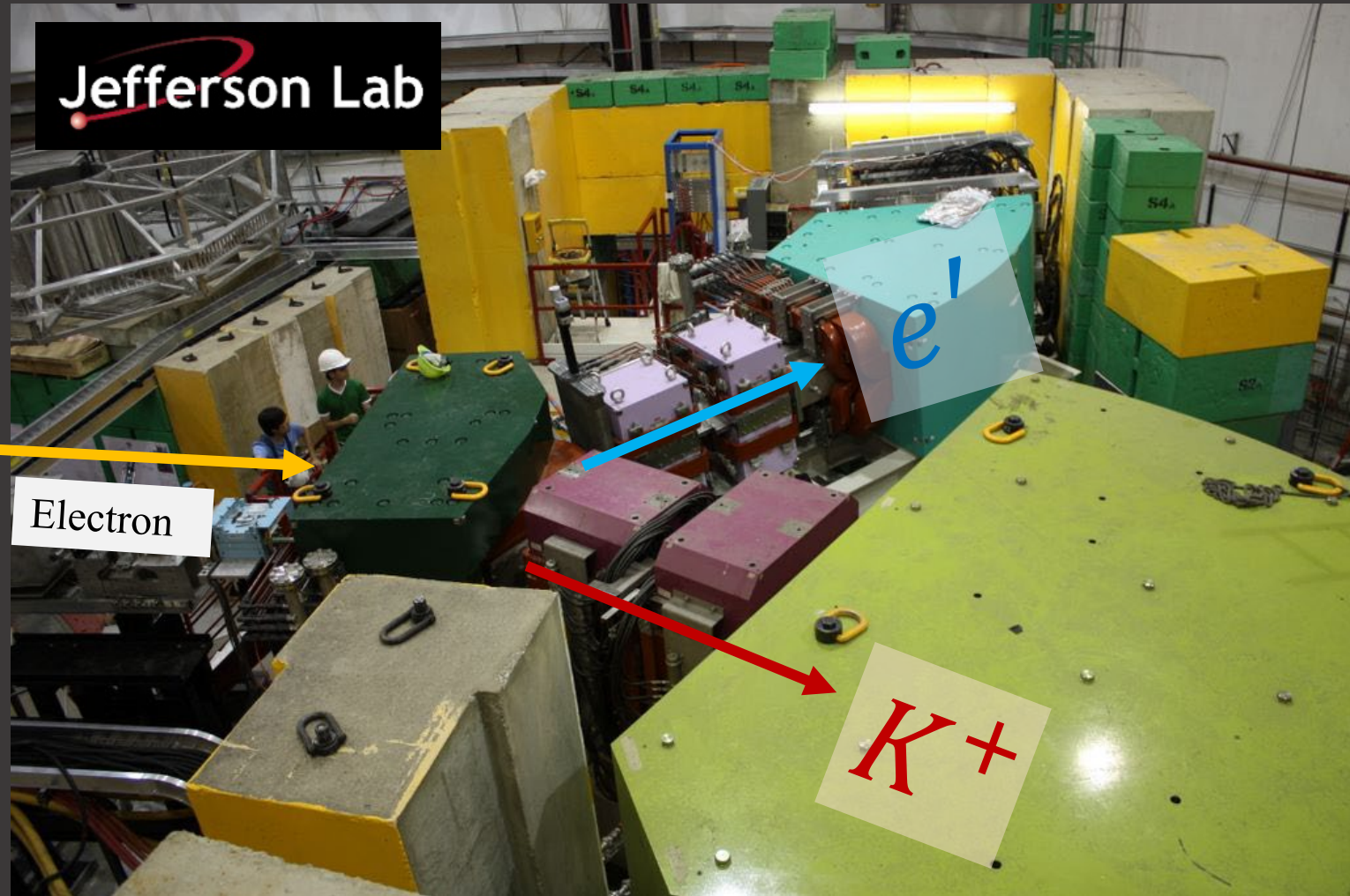

Approved: [E12-15-008](#), ([E12-19-002](#)), [E12-20-013](#)

Proposing next year: [LOI12-23-011](#), [LOI12-23-013](#), [LOI12-23-016](#)

Expected charged particle rate for each target

Target	Areal density [/(g/cm ²)]	Beam intensity (/ μA)	HES rate (/kHz)	HKS rate (/kHz)			Accidental coincidence ^(*) (/kHz)
			e'	π ⁺	K ⁺	p	
⁶ Li	100	50	120	22	0.27	28	1.0
⁹ Be			140	21	0.26	27	1.8
¹¹ B			170	21	0.25	26	2.1
²⁷ Al			930	20	0.24	25	10.5
⁴⁰ Ca	150	50	940	26	0.31	33	14.2
⁴⁸ Ca			1100	25	0.31	32	14.5
²⁰⁸ Pb			20	1300	8.2	0.24	10

(*) Assuming,
HES: 30 ns width
HKS: 200 ns width

Backup

(slides shown in the last meeting)

https://wiki.jlab.org/tegwiki/index.php/HYP_DAQ_Meeting_20231024

Next experiment at JLab Hall C (FY2026~)

Schematic from LOI12-23-013 (TG et al., Lol to PAC51):
https://researchmap.jp/gogami/published_papers/42361620/attachment_file.pdf

Hall A (original proposal) → Hall C

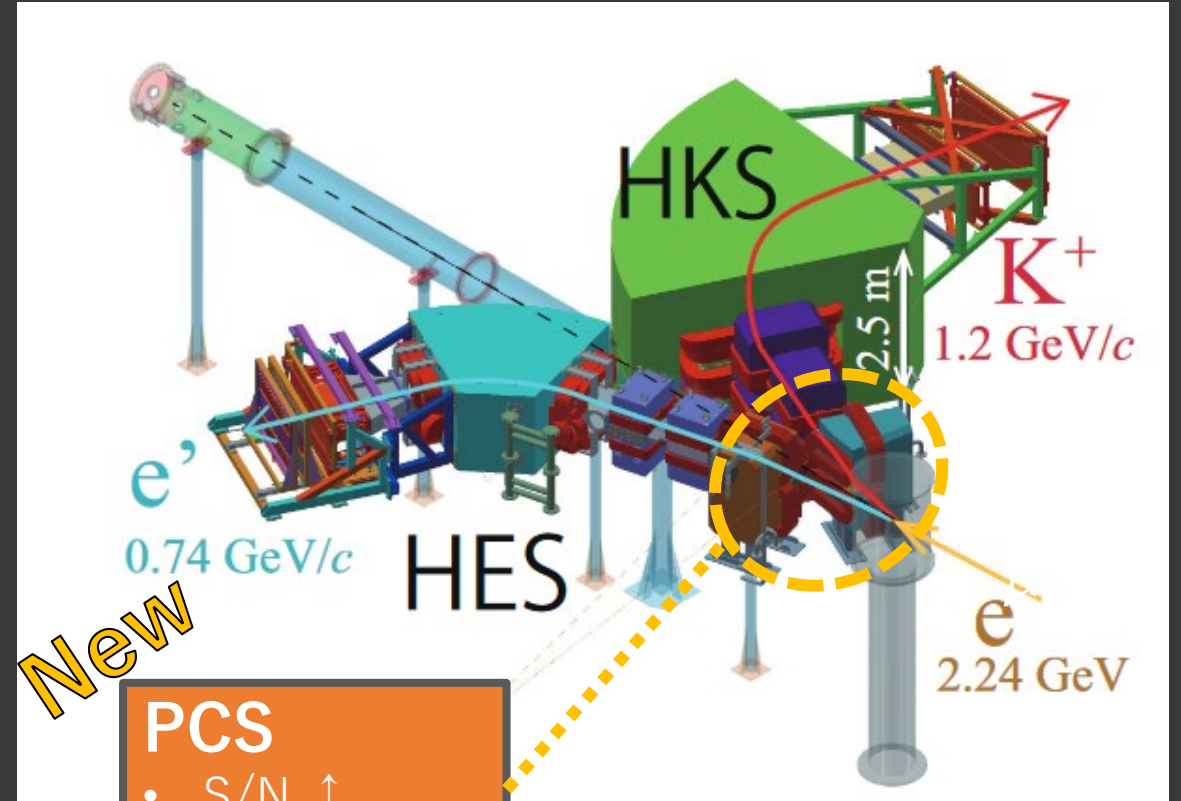
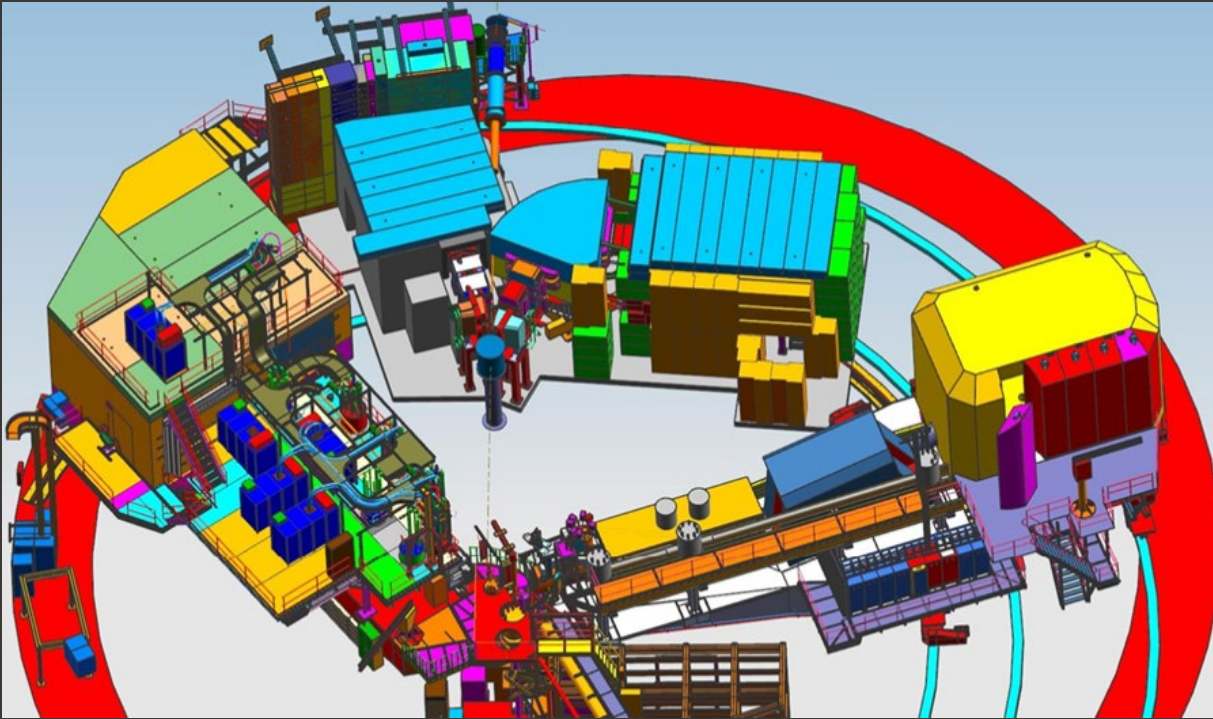

PCS

- S/N ↑
- Flexibility ↑

Existing spectrometers HES and HKS are going to be used

Particle Detectors in HES and HKS

HES e^-

HKS K^+
 p, π^+

TOF walls (Plastic scintillators)

Cherenkov detectors

- Aerogel ($n=1.05$)
- Water ($n=1.33$)

Drift chambers

Particle Detectors in HES and HKS

HES

e^-

K^+

p, π^+

HKS

	Detector	Current status	No. of channels		Ready?
			ADC	TDC	
HKS	Drift Chambers	To be tested	N/A	360 + 360	Yes
	TOF counters	All PMTs were checked	88	88	
	Aerogel Cherenkov	Test done	42	42	
	Water Cherenkov	New boxes under construction	48	48	
HES	Drift Chambers	To be tested	N/A	1098+360	
	TOF counters	To be tested	116	116	

Drift chambers

The number of ADC/TDC

	Detector	Current status	No. of channels		Ready?
			ADC	TDC	
HKS	Drift Chambers	To be tested	N/A	360 + 360	Yes
	TOF counters	All PMTs were checked	88	88	
	Aerogel Cherenkov	Test done	42	42	
	Water Cherenkov	New boxes under construction	48	48	
HES	Drift Chambers	To be tested	N/A	1098+360	
	TOF counters	To be tested	116	116	

ex.) FB 1877

Low resolution TDC

ex.) FB 1875

High resolution TDC

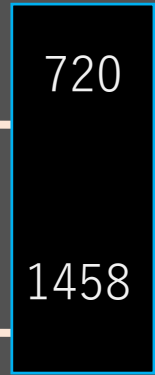

8 (768 ch)

88 2 (128 ch)

16 (1536 ch)

116 2 (128 ch)

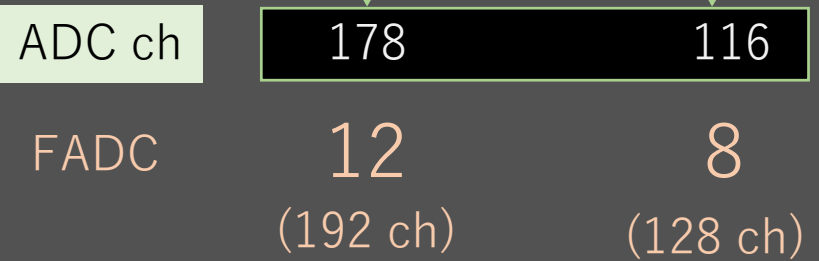

Spect.	FADC	LR TDC	HR TDC
HES	12	8	2
HKS	8	16	2
Total	20	24	4

96 ch/mod.

64 ch/mod.

Trigger condition

$$\text{COIN} = \text{HKS} \otimes \text{HES}$$

Expected charged particle rates

{ HES: 30 ns width
 HKS: 200 ns width

Beam current ($/\mu\text{A}$)	Target [$/(\text{mg}/\text{cm}^2)$]	Rate ($/\text{kHz}$)				Coincidence btw HES and HKS
		HES	HKS			
		e'	K^+	π^+	p	
50	^6Li	120	0.27	22	28	1.0
	^9Be (100)	140	0.26	21	27	1.8
	^{10}B	170	0.25	21	26	2.1
30	^6Li	73	0.16	13	17	0.5
	^9Be (100)	81	0.15	13	16	0.5
	^{10}B	100	0.15	12	16	0.3

Cherenkov counters may not need to be included in the trigger

Grouping trigger (in the case of HKS)

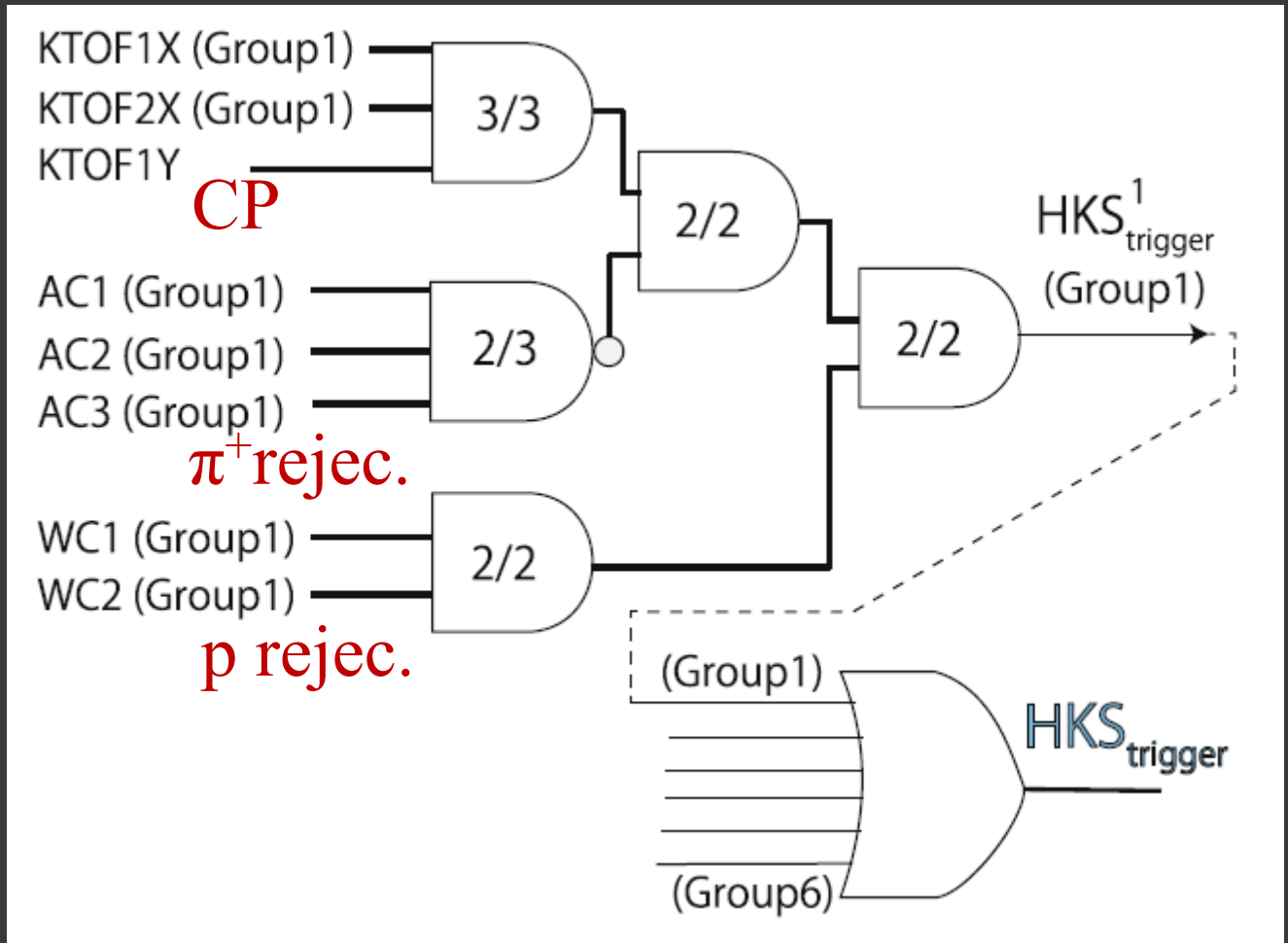
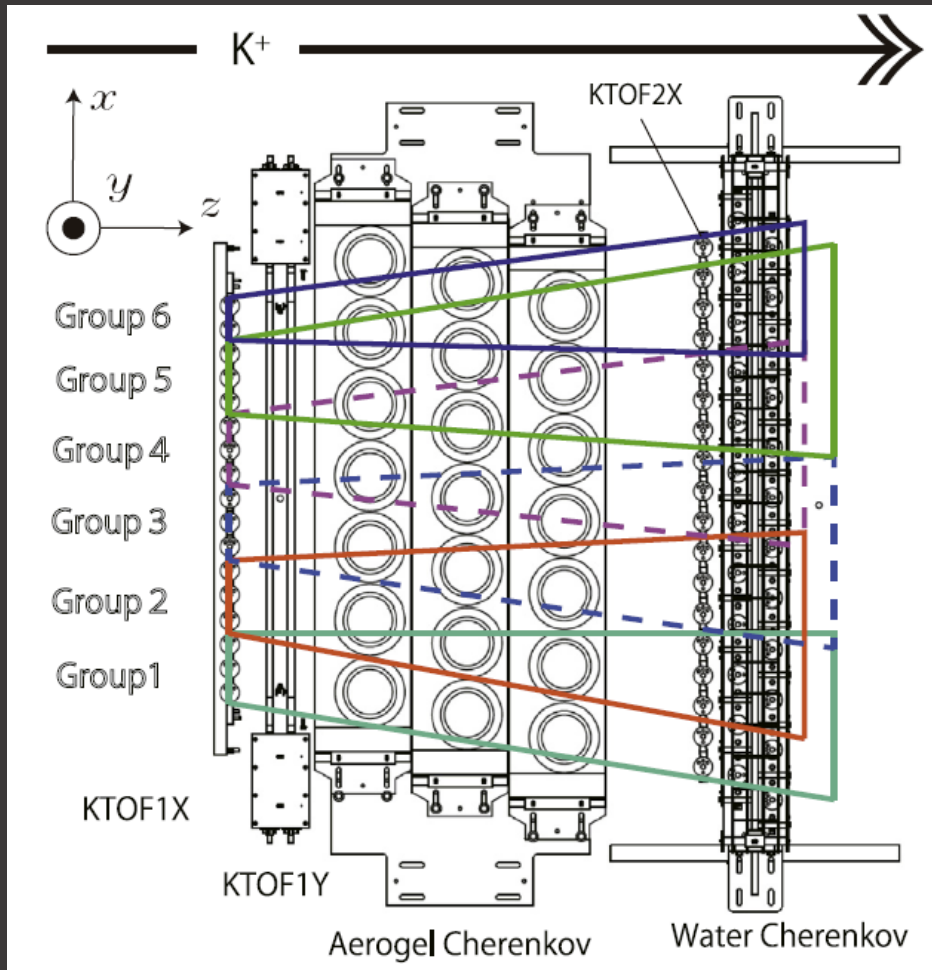

➡ Can FADC handle with this purpose?

Unbiased trigger

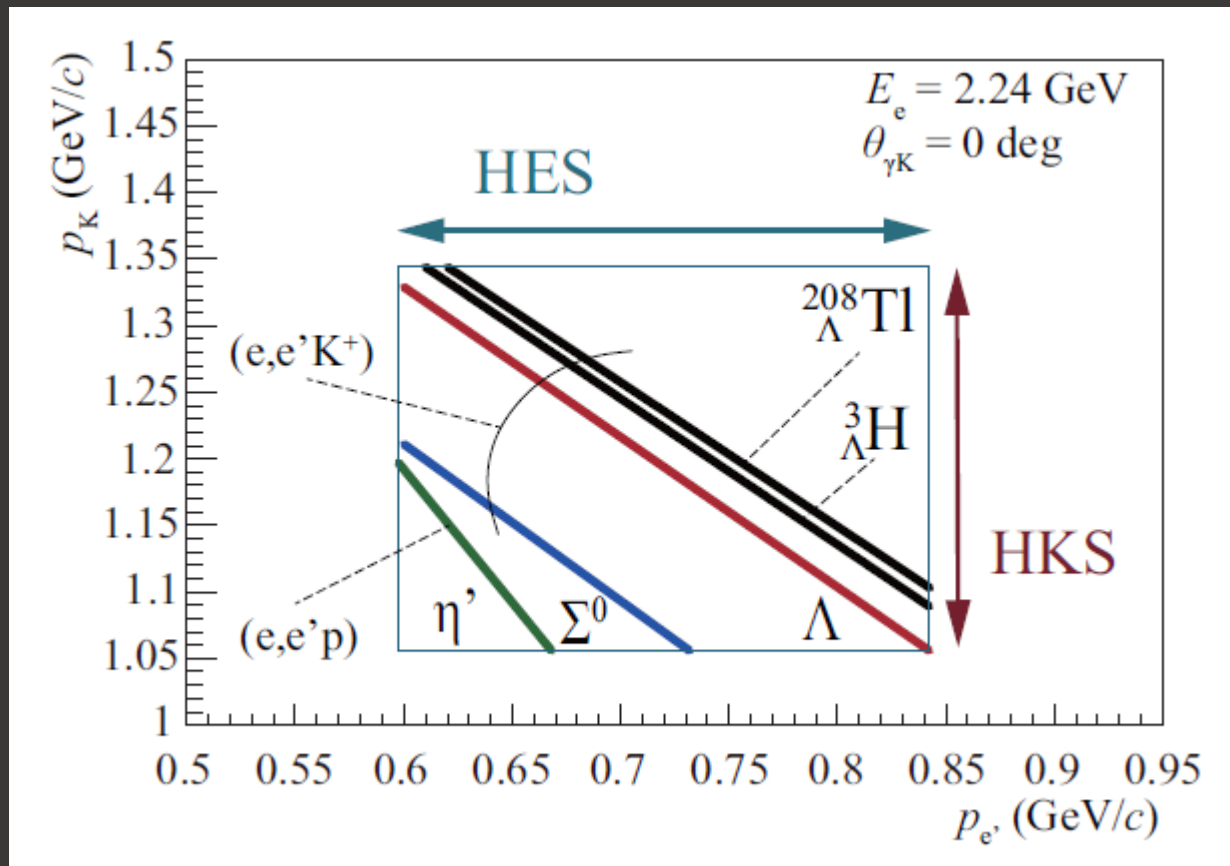

Unbiased trigger (such as CP trig.)
- prescale \rightarrow accumulate in data

To be checked

- Availability of resources
 - FADC, TDC and crates
- Trigger by FADC
 - possible? → (if so) any sample code? → Iwamoto (student at Kyoto Univ.)
- Meeting at JLab on Nov 14, 2023
 - to discuss what needs to be prepared for ERR, aiming to have the ERR in the beginning of 2024

